



**SUMINISTROS
INDUSTRIALES
DÍAZ**

CATÁLOGO

**IDEAL
TRIDON**



VISÍTENOS EN:

*Av. Puebla 515 Col. Palma Sola, CP 93320.
Poza Rica Veracruz, México*

Teléfonos: 7821606595, 7821604051 y 7821610766



contacto@sidadiaz.com



www.sidadiaz.com





Quienes somos	3
Ingeniería y Calidad	4
Cómo Usar este Catálogo	6
Productos	
SmartSeal® (37215)	8
WaveSeal ³⁶⁰ ® (36003)	8
SmartSeal® HD (38215)	8
Micro-Gear® (359, 62M, 62P, 52M)	10
Inyección de Combustible/Fuel Injection (52F)	11
1/2" Hy-Gear® (67-4, 67-1, 67-5, 57-0, 52-0, 67-6)	12
9/16" Hy-Gear® (63-4, 68-0, 50-0, 64-0)	14
Sin Perforaciones (9mm 533xx, 12mm 534xx)	16
Banda y Hebilla (60080, 60081, 60082)	18
Pinchadas/Abrazadera para Crimpeo y Herramienta (61)	19
Combo-Hex® (54-0)	20
Tornillo Sinfin para uso Militar (632)	20
Surelock Eganche Rápido (48, 49)	21
Snaplock® Liberación Rápida (56-0, 500, 58-0, 550)	22
Wraplock® (59-0)	24
Lox-On® (69-0)	24
Turn-Key® (5Y/6Y)	25
Instalador Flexible de Abrazaderas de Manguera (9999V)	25
Revestida/Lined (65E, 615, 53-0, 67M)	26
Pow'r Gear® (60, 6P, 6L, 6M, 6X)	28
Perno Tipo T: Diametro Minimo (30010, 30011, 30020, 30021)	30
Perno Tipo T: Diametro Nominal (30050, 30051)	32
Perno Tipo T Con Resorte de Carga (30030)	33
Bandas en V (24000)	34
Tapas de Seguridad para Abrazaderas	35
Flex-Gear® (43, 47, 41, 45)	36
Exhibidores y Empaques	38
Estante 130 Piezas	38
Estantes con Forma de Abrazaderas	38
Centro de Ganancias SmartSeal®	40
Bolsas para Contratistas de 25 Piezas	40
Bolsa con Surtido de 10 Piezas	41
Línea de Producto con Empaque de Burbuja	41
Guía de Referencia de Productos	43

Mercado de Abrazaderas

- Piezas de Reemplazo
- OEM: Fabricante de piezas originales
- Telecomunicaciones
- Equipo Pesado
- Gobierno y Militar
- Procesamiento de Alimentos y Sanidad
- Industrial
- Camiones y Máquinas
- Automotriz
- Marítima
- Ferretería
- Plomería

Presencia Global

- Tennessee, Estados Unidos - Oficinas Centrales
- Texas, Estados Unidos
- California, Estados Unidos
- Matamoros, México
- México City, México
- Suzhou, China
- Tokio, Japón
- Kudowa Zdro`j / Polonia
- Mumbai, India





La calidad superior, responsabilidad ambiental e integridad en el proceso de los productos IDEAL-TRIDON nos ha permitido recibir las certificaciones TS16949, ISO 9001 y ISO 14001.

Nosotros operamos usando lo último en instalaciones y equipos de manufactura, desde complejas manufacturas en red hasta avanzados análisis de laboratorio. Nuestro equipo diversificado de ingenieros y operadores está equipado con laboratorios de pruebas y máquinas con funciones de configuración altamente sofisticados. Nosotros probamos y certificamos el desempeño de nuestras abrazaderas apeándonos a rigurosos estándares dentro de la industria y a condiciones de la vida real para asegurar su satisfacción.

Una Asociación Poderosa

Permita que le ayudemos a crear una abrazadera para que la distribuya o a suplirle la próxima orden para su línea de producción. Nosotros podemos conectarlo con nuestros representantes de ventas y lo invitamos a que se asocie con nosotros al momento de planear su próximo programa de abrazaderas.

La marca IDEAL-TRIDON ofrece:

- Servicio incomparable al cliente
- Talento de ingeniería crítico para sus necesidades
- La mas amplia gama de superiores productos de sujecion

Personalización

IDEAL-TRIDON es la empresa líder en productos personalizados para el sellado de juntas. Nuestra empresa puede crear diseños personalizados para cualquier aplicación

de sujeción, bandas con muescas y perforaciones e incluso acabados especiales y diseños para las cabezas de tornillos. Mediante la utilización de modelos 3-D, los cuales incluyen análisis de estrés y de elementos finitos, podemos facilitarle a determinar cuáles son los mejores materiales y la configuración para su aplicación.

Opciones Personalizadas:

- Perforaciones y retenes especiales añadidos a las bandas
- Colocacion de sujetadores a abrazaderas previamente fijadas a mangueras
- Sujetadores de posicionamiento para ajustar la distancia de la abrazadera en el extremo de la manguera
- Abrazaderas con banda en V en configuraciones personalizadas con materiales específicos para su ambiente operacional
- Acabados de pintura negra electrostática /óxido negro
- ¡Y más!

Bien sea que necesite un producto estandarizado o atención especializada, tenemos el equipo, las instalaciones y los conocimientos necesarios para ofrecerle soluciones de sellado.





SUMINISTROS
INDUSTRIALES
DIAZ

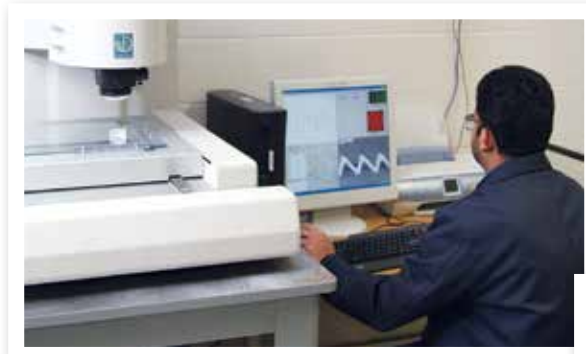

7821606595
7821604051
7821610766



contacto@sidadz.com



www.sidadz.com



CÓMO USAR ESTE CATÁLOGO

Explicación Para el Número de Parte

IDEAL-TRIDON utiliza **números de parte de 7 y 12 dígitos**. El número de parte de Tridon sólo se lista a modo de referencia. Armar el número de parte que necesita es un proceso que toma dos pasos fáciles.

1. **Seleccione el número de parte Ideal-Tridon-de acuerdo a la serie y tamaño** indicado en las tablas del catálogo.
2. **Agregue al final el código de empaque apropiado.**

Tipo de Empaque	Código de Empaque Para 7 Dígitos	Código de Empaque Para 12 Dígitos
10-Unidades (Hasta Tamaño 104)	51	051
Al por Mayor	52	052
10-Unidades con Código de Barra Individual (Hasta Tamaño 104)	53	053
Empaques de Blister	58	058

*Note que todos los productos están disponibles en una configuración de empaque de 10.

Productos Codificados con Colores Para Fácil Identificación

LOCALICE NÚMERO DE PARTE					Ideal-Tridon 67-4	Tridon 620P	Ideal-Tridon 67-5	Ideal-Tridon 67-1	Ideal-Tridon 57-0	Ideal-Tridon 52-0	Ideal-Tridon 67-6
Tamaño	Mínimo (pul)	Máximo (pul)	Mínimo (mm)	Máximo (mm)							
6	3/8	7/8	10	22	67004-0006	620-P06	6706-5	6706-1	57060	52060	6706-6
8	7/16	1	11	25	67004-0008	620-P08	6708-5	6708-1	57080	52080	6708-6

Diámetro Mínimo-Máximo

Sólo Como Referencia

Ordenar con el Número de Ideal-Tridon

EJEMPLO USANDO UN NÚMERO DE PARTE CON 12 DÍGITOS (Para Ordenar la Serie 67-4 Hy-Gear Tamaño 06 1/2" en Empaque de 10)

Series (Primeros 5 dígitos)	+	Tamaño (Sig. 4 dígitos)	+	Código de Empaque (Últimos 3 Dígitos)	=	Número de Parte Completo
67004 (Series 67-4)	+	0006 (4 Dígitos)	+	051 (Código de Empaque de 3 dígitos)	=	67004-0006-051

EJEMPLO USANDO UN NÚMERO DE PARTE CON 7 DÍGITOS (Para Ordenar la Serie 67-1 Hy-Gear Tamaño 06 1/2" en Empaque de 10)

Series y Tamaño (Primeros 5 Dígitos)	+	Código de Empaque (Próximos 2 Dígitos)	=	Número de Parte Completo
6706-1 (Series 67-1 en Tamaño 06)	+	51 (Empaque de 10 Unid)	=	6706-1-51



MAYOR RESISTENCIA A LA CORROSIÓN

LOCALICE EL MATERIAL PARA SU APLICACIÓN

		Acero al Carbono	Inoxidable 400	Inoxidable 200	Inoxidable 300	Inoxidable 316
Aplicación	Automotriz	•	•	•	•	•
	Agricultura	•		•	•	•
	Alimentos				•	•
	Jardinería			•	•	•
	Equipo Pesado		•		•	•
	Residencial	•	•	•	•	•
	Industrial/Mantenimiento y Reparación	•		•	•	•
	Marinas				•	•
	Médicas					•
	Plomería/Sistema de Agua		•	•	•	•
	Turbo/Aire Forzado		•		•	•
	Características	Superior Resistencia a la Corrosión				
Excelente Resistencia a la Corrosión					•	
Mejor Resistencia a la Corrosión				•		
Buena Resistencia a la Corrosión			•			
Propiedades*	Material "No magnético"			•	•	•
	Material "Magnético"	•	•			
Certificaciones	Enlistado por IAPMO**			•	•	

*Los materiales pueden exhibir cantidades de magnetismo residual, relativamente pequeñas como resultado del proceso de manufactura.

**Aplicaciones del producto enlistadas, según la Asociación Internacional de Oficiales de Plomería y Mecánica.

Llave de Icono

 BANDA Anchura y Material	 PERNO Tamaño y Material	 PUENTE Anchura y Material	 CARCASA Tamaño y Material	 REVESTIMIENTO Anchura y Material	 TUERCA Tamaño y Material
 TORNILLO Tamaño y Material	 RESORTE Tamaño y Material	 REVESTIMIENTO DE RESORTE Anchura y Material	 PERNO EN T Tamaño y Material	 MUÑÓN Material	 RIT* Pulg-lbs & Nm

***TORQUE RECOMENDADO PARA LA INSTALACIÓN**
Apretar demasiado su abrazadera puede dañar su manguera y disminuir la eficiencia de sujeción.

SmartSeal y **WaveSeal360** estas son abrazaderas híbridas inteligentes que aseguran las conexiones de mangueras para evitar escape no deseado de líquido y aire. Mediante una tecnología híbrida patentada, estas abrazaderas de la próxima generación sellan en un patrón constante de 360 grados, en respuesta a cambios de presión y temperatura. Con su diseño compacto y su perfil más bajo, se obtiene una abrazadera de alta resistencia y tensión óptima y constante sin ocupar tanto volumen.







SUMINISTROS INDUSTRIALES DIAZ







SmartSeal Ideal-Tridon 37215

			
Cabeza Hexagonal de 5/16"	Carcasa	Banda 1/2"	Anillo de 1/2"
Inoxidable 300	Inoxidable 300	Inoxidable 300	Inoxidable 300

WaveSeal³⁶⁰ Ideal-Tridon 36003

			
Cabeza Hexagonal de 5/16"	Carcasa	Banda 9/16"	Anillo de 9/16"
Inoxidable 410	Inoxidable 300	Inoxidable 300	Inoxidable 300

SmartSeal HD Ideal-Tridon 38215

			
Cabeza Hexagonal de 5/16"	Carcasa de 2 Piezas	Banda 5/8"	Anillo de 5/8"
Inoxidable 410	Inoxidable 300	Inoxidable 300	Inoxidable 300

SMARTSEAL DISEÑO DEL CANAL



Alta Presión

- Compensación de resorte sobre los 360 grados
- Mayor redondez de la abrazadera, eliminando vías de fuga en la unión con la carcasa
- El diseño acanalado crea mayor resistencia a la carga, en comparación con el diseño helicoidal convencional, aumentando la resistencia a posibles fugas
- La forma del conducto ayuda a sujetar, pudiendo penetrar más profundamente en la pared de la manguera sobre una sección transversal más estrecha (huella)

WAVESEAL EFECTO DE ANILLO EN O



Alta Presión Baja Presión Alta Presión

- Compensación de resorte sobre los 360 grados
- Mayor redondez de la abrazadera, eliminando vías de fuga en la unión con la carcasa
- El diseño con efecto tipo O-Ring permite que la manguera actúe como un componente adicional al fleje
- En el exterior, el borde en ángulo interno protege a la manguera contra cortes

¿CUÁL ABRAZADERA ES LA APROPIADA?

Guía General	SmartSeal	WaveSeal ³⁶⁰	SmartSeal HD
Grosor de la Pared	Mayor que .177" (4.5 mm)	Menor que .177" (4.5 mm)	.080 a .315" (2-8 mm)
Diámetro de la Manguera	Más de 3" (76 mm)	Menos de 3" (76 mm)	Más de 2" (51 mm)
Torque de Instalación (Mayoría de las Aplicaciones)	Hasta 48 lbs-pulg (5.4 Nm)	Hasta 70 lb-pulg (7.9 Nm)	Hasta 100 lb-pulg (11.3 Nm)
Ancho de la Banda	1/2"	9/16"	5/8"

LOCALICE NÚMERO DE PARTE

Tamaño	Mínimo (pul)	Máximo (pul)	Mínimo (mm)	Máximo (mm)	SmartSeal	WaveSeal ³⁶⁰
16	1-3/32	1-9/32	28	33	37215-0016*	36003-0016
20	1-1/8	1-9/16	29	40	37215-0020*	36003-0020
22	1-7/16	1-11/16	36	43	37215-0022	36003-0022
24	1-1/2	1-13/16	38	46	37215-0024*	36003-0024
28	1-3/4	2-1/16	43	52	37215-0028*	36003-0028
32	1-15/16	2-5/16	48	59	37215-0032	36003-0032
34	2	2-7/16	50	62	37215-0034	36003-0034
36	2-1/8	2-9/16	53	65	37215-0036*	36003-0036
40	2-5/16	2-13/16	58	71	37215-0040*	36003-0040
44	2-1/2	3-1/16	63	78	37215-0044	36003-0044
48	2-11/16	3-5/16	67	84	37215-0048	36003-0048
52	2-7/8	3-9/16	73	91	37215-0052	36003-0052
56	3-1/16	3-13/16	77	97	37215-0056	36003-0056
60	3-1/4	4-1/16	82	103	37215-0060	36003-0060
64	3-7/16	4-5/16	87	110	37215-0064	36003-0064
72	3-3/4	4-13/16	96	122	37215-0072	36003-0072
80	4-3/16	5-5/16	105	135	37215-0080	36003-0080
88	4-1/2	5-13/16	115	148	37215-0088	36003-0088

Serie 37215 Smart Seal también disponible en sub empaques en cajas de 10 Pcs con código de barra individual

*Disponible en empaques tipo blíster

LOCALICE NÚMERO DE PARTE

Tamaño	Mínimo (pul)	Máximo (pul)	Mínimo (mm)	Máximo (mm)	SmartSeal HD
238	1-5/8	2-1/8	42	54	38215-0238
262	1-7/8	2-3/8	48	61	38215-0262
275	2	2-1/2	52	64	38215-0275
288	2-1/8	2-5/8	55	67	38215-0288
300	2-1/4	2-3/4	58	70	38215-0300
325	2-1/2	3	64	77	38215-0325
350	2-3/4	3-1/4	70	83	38215-0350
375	2-7/8	3-1/2	74	90	38215-0375
400	3-1/8	3-3/4	79	96	38215-0400
425	3-5/16	4	84	103	38215-0425
450	3-7/16	4-1/4	88	109	38215-0450
512	4-1/16	4-7/8	103	125	38215-0512
562	4-9/16	5-3/8	115	137	38215-0562
612	5-1/16	5-7/8	128	150	38215-0612



Las abrazaderas **Micro-Gear** son pequeñas, resistentes y fabricadas con ingeniería de precisión para uso en aplicaciones de mangueras pequeñas, por ejemplo para el control de las emisiones, líneas de combustible y mangueras de vacío. Las delgadas bandas de 5/16" y la carcasa de bajo perfil permiten su instalación en espacios reducidos.



SUMINISTROS INDUSTRIALES DIAZ



Micro-Gear Tridon 359

• SUPERIOR •



Cabeza Hexagonal de 1/4"



Inoxidable 316

Carcasa



Inoxidable 316

Ancho de la Banda 5/16"



Inoxidable 316

Micro-Gear Ideal-Tridon 62M • Tridon 345/MAH

• MEJOR •



Cabeza Hexagonal de 1/4"



Inoxidable 300

Carcasa



Inoxidable 300

Ancho de la Banda 5/16"



Inoxidable 300

Micro-Gear Ideal-Tridon 62P • Tridon 325/MH

• BUENA •



Cabeza Hexagonal de 1/4"



Acero Carbono Recubierto

Carcasa



Inoxidable 300

Ancho de la Banda 5/16"



Inoxidable 300

Micro-Gear Ideal-Tridon 52M

• ECONÓMICA •



Cabeza Hexagonal de 1/4"



Acero Carbono Recubierto

Carcasa



Acero Carbono Recubierto

Ancho de la Banda 5/16"



Inoxidable 300



Instalación de 10 a 15 pulg-lbs (1.1 a 1.7 Nm) para la mayoría de las aplicaciones



LOCALICE NÚMERO DE PARTE

Tamaño	Mínimo (pul)	Máximo (pul)	Mínimo (mm)	Máximo (mm)	Tridon 359	Ideal-Tridon 62M	Ideal-Tridon 62P	Ideal-Tridon 52M
04	5/16	5/8	8	16	359-004	62604 ⁽¹⁾	6204 ⁽³⁾	5202
05	5/16	3/4	8	19	-	62M05	62P05	-
06	5/16	7/8	8	22	359-006	62606 ⁽²⁾	6206 ⁽⁴⁾	5203
08	7/16	1	11	25	359-008	62M08	62P08	-
10	1/2	1-1/16	13	27	359-010	62M10	62P10	-
12	9/16	1-1/4	14	32	-	62M12	62P12	-
16	11/16	1-1/2	18	38	-	62M16	62P16	-
20	3/4	1-3/4	19	44	-	62M20	62P20	-
24	1	2	26	51	-	62M24	62P24	-
28	1-1/4	2-1/4	32	57	-	62M28	62P28	-
30	1-3/8	2-3/8	35	60	-	62M30	62P30	-
32	1-1/2	2-1/2	38	63	-	62M32	62P32	-
36	1-3/4	2-3/4	45	70	-	62M36	62P36	-
44	2-1/4	3-1/4	57	82	-	62M44	62P44	-
48	2-1/2	3-1/2	64	89	-	62M48	62P48	-

⁽¹⁾ Antiguo número de parte 62602 ⁽²⁾ Antiguo número de parte 62603 ⁽³⁾ Antiguo número de parte 6202 ⁽⁴⁾ Antiguo número de parte 6203

Abrazaderas Para Inyección de Combustible estas abrazaderas están diseñadas para proporcionar la presión de sellado uniforme requerida en las tuberías para inyección de combustible. Cuentan con una banda continua con bordes redondeados y un diseño especial de tuerca y perno.

Abrazaderas Para Inyección de Combustible Ideal-Tridon 52F • Tridon 905/FI



ESPECIALIDAD

Cabeza Hexagonal de 7 mm



Acero Carbono Recubierto

Ancho de la Banda 9 mm



Acero Carbono Recubierto

LOCALICE NÚMERO DE PARTE

Tamaño	Mínimo (pul)	Máximo (pul)	Mínimo (mm)	Máximo (mm)	Ideal-Tridon 52F	Tridon 905/FI
13	7/16	1/2	11	13	52F13	905-004
15	1/2	9/16	13	15	52F15	905-006
16	9/16	5/8	14	16	52F16	905-008

Las abrazaderas **Hy-Gear de 1/2"** son adecuadas para las aplicaciones más comunes en el hogar, en la industria y en la reparación de automóviles. Las bandas tienen perforaciones precisas rectangulares que mantienen un fuerte contacto, permitiendo su fácil conexión.







SUMINISTROS INDUSTRIALES DIAZ



1/2" Hy-Gear Ideal-Tridon 67-4 • Tridon 620P

• SUPERIOR •







Cabeza Hexagonal de 5/16"	Carcasa	Ancho de la Banda 1/2"
		
Inoxidable 300	Inoxidable 300 Estampado UPC*	Inoxidable 300

*Código Uniforme de Plomería

1/2" Hy-Gear Ideal-Tridon 67-1

• MEJOR •





Cabeza Hexagonal de 5/16"	Carcasa	Ancho de la Banda 1/2"
		
Inoxidable 410*	Inoxidable 200	Inoxidable 200

1/2" Hy-Gear Ideal-Tridon 67-5

• MEJOR •



Cabeza Hexagonal de 5/16"	Carcasa	Ancho de la Banda 1/2"
		
Inoxidable 200	Inoxidable 200	Inoxidable 200

1/2" Hy-Gear Ideal-Tridon 57-0 • Tridon 611/HS

• BUENA •





Cabeza Hexagonal de 5/16"	Carcasa	Ancho de la Banda 1/2"
		
Acero Carbono Recubierto	Inoxidable 200	Inoxidable 200

1/2" Hy-Gear Ideal-Tridon 52-0

• ECONÓMICA •





Cabeza Hexagonal de 5/16"	Carcasa	Ancho de la Banda 1/2"
		
Acero Carbono Recubierto	Acero Carbono Recubierto	Inoxidable 200

1/2" Hy-Gear Ideal-Tridon 67-6 • Tridon 665

• ESPECIALIDAD •



Cabeza Hexagonal de 5/16"	Carcasa	Ancho de la Banda 1/2"
		
Inoxidable 316	Inoxidable 316	Inoxidable 316



LOCALICE NÚMERO DE PARTE

Tamaño	Mínimo (pul)	Máximo (pul)	Mínimo (mm)	Máximo (mm)	Ideal-Tridon 67-4	Tridon 620P	Ideal-Tridon 67-1	Ideal-Tridon 67-5	Ideal-Tridon 57-0	Ideal-Tridon 52-0	Ideal-Tridon 67-6
6	3/8	7/8	10	22	67004-0006	620-P06	6706-1	6706-5	57060	52060	6706-6
8	7/16	1	11	25	67004-0008	620-P08	6708-1	6708-5	57080	52080	6708-6
10	1/2	1-1/16	13	27	67004-0010	620-P10	6710-1	6710-5	57100	52100	6710-6
12	1/2	1-1/4	13	32	67004-0012	620-P12	6712-1	6712-5	57120	52120	6712-6
16	11/16	1-1/2	18	38	67004-0016	620-P16	6716-1	6716-5	57160	52160	6716-6
20	3/4	1-3/4	19	44	67004-0020	620-P20	6720-1	6720-5	57200	52200	6720-6
24	1	2	25	51	67004-0024	620-P24	6724-1	6724-5	57240	52240	6724-6
28	1-1/4	2-1/4	32	57	67004-0028	620-P28	6728-1	6728-5	57280	52280	6728-6
32	1-1/2	2-1/2	38	63	67004-0032	620-P32	6732-1	6732-5	57320	52320	6732-6
36	3/4	2-3/4	19	70	67004-0036	620-P36*	6736-1	6736-5	57360	52360	6736-6
40	1	3	26	76	67004-0040	620-P40*	6740-1	6740-5	57400	52400	6740-6
44	1-1/4	3-1/4	32	82	67004-0044	620-P44*	6744-1	6744-5	57440	52440	6744-6
48	1-1/2	3-1/2	38	89	67004-0048	620-P48*	6748-1	6748-5	57480	52480	6748-6
52	1-3/4	3-3/4	44	95	67004-0052	620-P52*	6752-1	6752-5	57520	52520	6752-6
56	2	4	51	101	67004-0056	620-P56*	6756-1	6756-5	57560	52560	6756-6
60	2-1/4	4-1/4	57	108	67004-0060	620-P60*	6760-1	6760-5	57600	52600	6760-6
64	2-1/2	4-1/2	64	114	67004-0064	620-P64	6764-1	6764-5	57640	52640	6764-6
72	3	5	76	127	67004-0072	620-P72	6772-1	6772-5	57720	52720	6772-6
80	3-1/2	5-1/2	89	140	67004-0080	620-P80	6780-1	6780-5	57800	52800	6780-6
88	4	6	102	152	67004-0088	620-P88	6788-1	6788-5	57880	52880	6788-6
96	4-1/2	6-1/2	114	165	67004-0096	620-P96	6796-1	6796-5	57960	52960	6796-6
104	5	7	127	178	67004-0104	62P-104	67104	6799-5	57104	52104	6799-6
112	5-1/2	7-1/2	140	190	67004-0112						
116	5-3/4	7-3/4	146	197	67004-0116						
120	6	8	152	203	67004-0120						
128	6-1/2	8-1/2	165	216	67004-0128						
132	6-3/4	8-3/4	171	222	67004-0132						
140	7-1/4	9-1/4	184	235	67004-0140						
152	2	10	51	254	67004-0152						
164	1-3/4	10-3/4	44	273	67004-0164						
176	9-1/2	11-1/2	241	292	67004-0176						
188	2	12-1/4	52	311	67004-0188						
208	11-1/4	13-1/2	294	343	67004-0208						
212	11-1/2	13-3/4	300	349	67004-0212						
224	12-1/2	14-1/2	319	368	67004-0224						
236	13-1/4	15-1/4	338	387	67004-0236						
248	1-3/4	16	44	406	67004-0248						
270	15-1/4	17-1/2	392	441	67004-0270						
312	18	20	459	508	67004-0312						
332	19-1/4	21-1/4	491	540	67004-0332						
390	14-1/2	25	371	636	67004-0390						
502	28	32	711	812	67004-0502						
538	24-3/4	34-1/4	628	869	67004-0538						
569	32	36-1/4	810	819	67004-0569						

*Rango de diámetro puede variar. Por favor llame para más información.

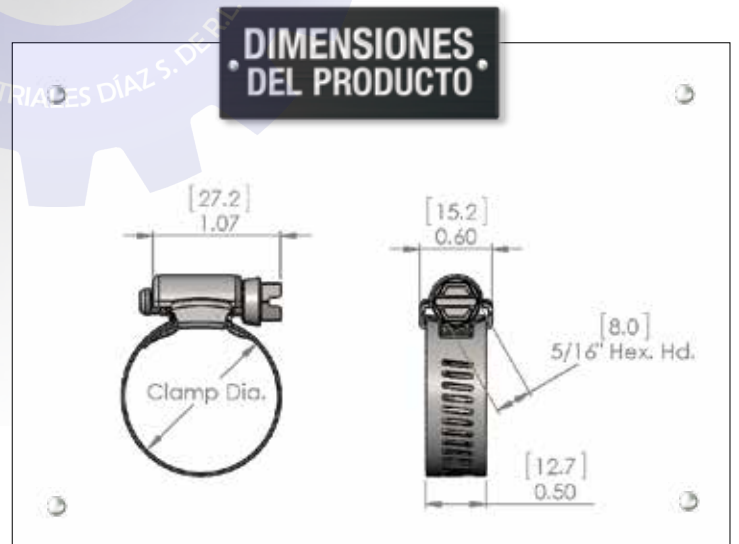

Instalación a 35 pulg-lbs (4 Nm) para la mayoría de las aplicaciones

Tamaños adicionales disponibles

7821606595
7821604051
7821610766



contacto@sidadz.com



www.sidadz.com



SUMINISTROS
INDUSTRIALES
DÍAZ

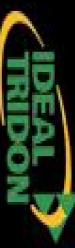

Las abrazaderas **Hy-Gear de 9/16"** tienen una amplia gama de aplicaciones, desde aplicaciones simples para el hogar y la reparación de automóviles hasta para la industria pesada. Las bandas tienen perforaciones rectangulares precisas que mantienen un fuerte contacto, permitiendo su fácil conexión.



Hy-Gear Ideal-Tridon 63-4

• SUPERIOR •	Cabeza Hexagonal de 5/16"  Inoxidable 300	Carcasa  Inoxidable 300 Estampado UPC*	Ancho de la Banda 9/16"  Inoxidable 300
--------------	--	--	--

*Código Uniforme de Plomería



Hy-Gear Ideal-Tridon 68-0

• MEJOR •	Cabeza Hexagonal de 5/16"  Inoxidable 410	Carcasa  Inoxidable 200	Ancho de la Banda 9/16"  Inoxidable 200
-----------	--	--	--



Hy-Gear Ideal-Tridon 50-0 • Tridon 150

• BUENA •	Cabeza Hexagonal de 5/16"  Acero Carbono Recubierto	Carcasa  Inoxidable 200	Ancho de la Banda 9/16"  Inoxidable 200
-----------	--	--	--



Hy-Gear Ideal-Tridon 64-0

• ESPECIALIDAD •	Cabeza Hexagonal de 3/8"  Inoxidable 410	Carcasa  Inoxidable 200	Ancho de la Banda 9/16"  Inoxidable 200
------------------	---	--	--



Instalación a 35 pulg-lbs (4 Nm) para la mayoría de las aplicaciones



SUMINISTROS INDUSTRIALES DIAZ



LOCALICE NÚMERO DE PARTE

Tamaño	Mínimo (pul)	Máximo (pul)	Mínimo (mm)	Máximo (mm)	Ideal-Tridon 63-4	Ideal-Tridon 68-0	Ideal-Tridon 50-0	Ideal-Tridon 64-0
6	3/8	7/8	10	22	63004-0006	68060	50060	64060
8	7/16	1	11	25	63004-0008	68080	50080	64080
10	1/2	1-1/16	13	27	63004-0010	68100	50100	64100
12	1/2	1-1/4	13	32	63004-0012	68120	50120	64120
16	11/16	1-1/2	18	38	63004-0016	68160	50160	64160
20	3/4	1-3/4	19	44	63004-0020	68200	50200	64200
24	1	2	25	51	63004-0024	68240	50240	64240
28	1-1/4	2-1/4	32	57	63004-0028	68280	50280	64280
32	1-1/2	2-1/2	38	63	63004-0032	68320	50320	64320
36	3/4	2-3/4	19	70	63004-0036	68360	50360	64360
40	1	3	26	76	63004-0040	68400	50400	64400
44	1-1/4	3-1/4	32	83	63004-0044	68440	50440	64440
48	1-1/2	3-1/2	38	89	63004-0048	68480	50480	64480
52	1-3/4	3-3/4	44	95	63004-0052	68520	50520	64520
56	2	4	51	101	63004-0056	68560	50560	64560
60	2-1/4	4-1/4	57	108	63004-0060	68600	50600	64600
64	2-1/2	4-1/2	64	114	63004-0064	68640	50640	64640
72	3	5	76	127	63004-0072	68720	50720	64720
80	3-1/2	5-1/2	89	140	63004-0080	68800	50800	64800
88	4	6	102	152	63004-0088	68880	50880	64880
96	4-1/2	6-1/2	114	165	63004-0096	68960	50960	64960
104	5	7	127	178	63004-0104	68104	50104	64104
116	5-3/4	7-3/4	146	197	63004-0116			
128	2-1/2	8-1/2	64	216	63004-0128			
140	2-1/2	9-1/4	64	235	63004-0140			
152	2-1/2	10	64	254	63004-0152			
164	2-1/2	10-3/4	64	273	63004-0164			
176	2-1/2	11-1/2	64	292	63004-0176			
188	2-1/2	12-1/4	64	311	63004-0188			
208	2-1/2	13-1/2	64	343	63004-0208			
224	2-1/2	14-1/2	64	368	63004-0224			
236	2-1/2	15-1/4	64	387	63004-0236			
248	2-1/2	16	64	406	63004-0248			
260	2-1/2	16-3/4	64	425	63004-0260			
272	2-1/2	17-1/2	64	445	63004-0272			
312	2-1/2	20	64	508	63004-0312			
380	2-1/2	24-1/4	64	616	63004-0380			
760	2-1/2	48	64	1219	63004-0760			

Tamaños adicionales disponibles



SUMINISTROS INDUSTRIALES DIAZ



Las abrazaderas **Sin Perforaciones** se basan en nuestras populares abrazaderas de tornillo de uso múltiple, pero las mismas están diseñadas para prevenir daños en la manguera durante la instalación. La banda sin perforaciones evita que las mangueras de silicón suave se desgarran o deformen durante la instalación y el torque final, manteniendo así la integridad de la conexión, y creando también un sello más estable. Además, las abrazaderas sin perforaciones IDEAL TRIDON están disponibles en configuraciones con diferentes materiales, de manera que son perfectas para aplicaciones industriales como para la industria automotriz, marítima, y muchas otras. Aún mejor, las mismas se comportan ajustadas abrazaderas de tornillos tradicionales, entrando perfectamente en espacios restringidos y manteniéndose apretadas a través del tiempo. Considere las abrazaderas de tornillo sin perforaciones en su próximo proyecto y tenga la seguridad que su conexión estará segura con nuestra tecnología de abrazaderas que no dañan al apretar.

CARCASA ANCHA

Al instalarse, las monturas anchas nos brindan una estructura de soporte más pareja y una tensión en la banda a largo plazo.



SATISFACE O SOBREPASA EL ESTÁNDAR DIN 3017

ESPECIFICACIONES DEL MATERIAL Y RANGOS DE SUJECIÓN

Las especificaciones del material y rangos de sujeción están estampados en la banda de la abrazadera para que se puedan identificar fácilmente y se empleen en el montaje apropiado. (Vea tabla a la derecha)

BANDA CON RECUBRIMIENTO INTERIOR LISO

La banda con recubrimiento interior liso protege las mangueras suaves contra rupturas extendiendo así la vida útil de las mismas.

Banda de 9 mm



7 mm Cabeza Hexagonal



Carcasa



9 mm Ancho de la Banda



Para la composición del material por favor vea la tabla a la derecha.



Instalación a 18 pulg-lbs (2.0 Nm) para los tamaños de 16 y menor
Instalación a 27 in-lbs (3.0 Nm) para los tamaños de 16 y mayor

Banda de 12 mm



7 mm Cabeza Hexagonal



Carcasa



12 mm Ancho de la Banda



Para la composición del material por favor vea la tabla a la derecha.



Instalación a 44 pulg-lbs (5.0 Nm) para la mayoría de las aplicaciones

LOCALICE NÚMERO DE PARTE

Band Width	Mínimo (pul)	Máximo (pul)	Mínimo (mm)	Máximo (mm)	W2 Ideal-Tridon	W2 Tridon	W3 Ideal-Tridon	W3 Tridon	W4 Ideal-Tridon	W4 Tridon	W5 Ideal-Tridon	W5 Tridon
9 mm	5/16	15/32	8	12	53302-0012	53312-0012	53303-0012	53313-0012	53304-0012	53314-0012	53305-0012	53315-0012
	5/16	5/8	8	16	53302-0016	53312-0016	53303-0016	53313-0016	53304-0016	53314-0016	53305-0016	53315-0016
	15/32	25/32	12	20	53302-0020	53312-0020	53303-0020	53313-0020	53304-0020	53314-0020	53305-0020	53315-0020
	15/32	7/8	12	22	53302-0022	53312-0022	53303-0022	53313-0022	53304-0022	53314-0022	53305-0022	53315-0022
	5/8	1-1/16	16	27	53302-0027	53312-0027	53303-0027	53313-0027	53304-0027	53314-0027	53305-0027	53315-0027
	25/32	1-1/4	20	32	53302-0032	53312-0032	53303-0032	53313-0032	53304-0032	53314-0032	53305-0032	53315-0032
	29/32	1-3/8	23	35	53302-0035	53312-0035	53303-0035	53313-0035	53304-0035	53314-0035	53305-0035	53315-0035
	1	1-9/16	25	40	53302-0040	53312-0040	53303-0040	53313-0040	53304-0040	53314-0040	53305-0040	53315-0040
	1-3/16	1-3/4	30	45	53302-0045	53312-0045	53303-0045	53313-0045	53304-0045	53314-0045	53305-0045	53315-0045
	1-1/4	1-31/32	32	50	53302-0050	53312-0050	53303-0050	53313-0050	53304-0050	53314-0050	53305-0050	53315-0050
	1-9/16	2-3/8	40	60	53302-0060	53312-0060	53303-0060	53313-0060	53304-0060	53314-0060	53305-0060	53315-0060
	1-31/32	2-3/4	50	70	53302-0070	53312-0070	53303-0070	53313-0070	53304-0070	53314-0070	53305-0070	53315-0070
	2-3/8	3-1/8	60	80	53302-0080	53312-0080	53303-0080	53313-0080	53304-0080	53314-0080	53305-0080	53315-0080
	2-3/4	3-1/2	70	90	53302-0090	53312-0090	53303-0090	53313-0090	53304-0090	53314-0090	53305-0090	53315-0090
	3-1/8	3-15/16	80	100	53302-0100	53312-0100	53303-0100	53313-0100	53304-0100	53314-0100	53305-0100	53315-0100
	3-1/2	4-5/16	90	110	53302-0110	53312-0110	53303-0110	53313-0110	53304-0110	53314-0110	53305-0110	53315-0110
	3-15/16	4-23/32	100	120	53302-0120	53312-0120	53303-0120	53313-0120	53304-0120	53314-0120	53305-0120	53315-0120
	4-5/16	5-1/8	110	130	53302-0130	53312-0130	53303-0130	53313-0130	53304-0130	53314-0130	53305-0130	53315-0130
	4-23/32	5-1/2	120	140	53302-0140	53312-0140	53303-0140	53313-0140	53304-0140	53314-0140	53305-0140	53315-0140
	5-1/8	5-29/32	130	150	53302-0150	53312-0150	53303-0150	53313-0150	53304-0150	53314-0150	53305-0150	53315-0150
	5-1/2	6-5/16	140	160	53302-0160	53312-0160	53303-0160	53313-0160	53304-0160	53314-0160	53305-0160	53315-0160
12 mm	5/8	1-1/16	16	27	53402-0027	53412-0027	53403-0027	53413-0027	53404-0027	53414-0027	53405-0027	53415-0027
	25/32	1-1/4	20	32	53402-0032	53412-0032	53403-0032	53413-0032	53404-0032	53414-0032	53405-0032	53415-0032
	1	1-9/16	25	40	53402-0040	53412-0040	53403-0040	53413-0040	53404-0040	53414-0040	53405-0040	53415-0040
	1-3/16	1-3/4	30	45	53402-0045	53412-0045	53403-0045	53413-0045	53404-0045	53414-0045	53405-0045	53415-0045
	1-1/4	1-31/32	32	50	53402-0050	53412-0050	53403-0050	53413-0050	53404-0050	53414-0050	53405-0050	53415-0050
	1-9/16	2-3/8	40	60	53402-0060	53412-0060	53403-0060	53413-0060	53404-0060	53414-0060	53405-0060	53415-0060
	1-31/32	2-3/4	50	70	53402-0070	53412-0070	53403-0070	53413-0070	53404-0070	53414-0070	53405-0070	53415-0070
	2-3/16	2-15/16	55	75	53402-0075	53412-0075	53403-0075	53413-0075	53404-0075	53414-0075	53405-0075	53415-0075
	2-3/8	3-1/8	60	80	53402-0080	53412-0080	53403-0080	53413-0080	53404-0080	53414-0080	53405-0080	53415-0080
	2-3/4	3-1/2	70	90	53402-0090	53412-0090	53403-0090	53413-0090	53404-0090	53414-0090	53405-0090	53415-0090
	3-1/8	3-15/16	80	100	53402-0100	53412-0100	53403-0100	53413-0100	53404-0100	53414-0100	53405-0100	53415-0100
	3-1/2	4-5/16	90	110	53402-0110	53412-0110	53403-0110	53413-0110	53404-0110	53414-0110	53405-0110	53415-0110
	3-15/16	4-23/32	100	120	53402-0120	53412-0120	53403-0120	53413-0120	53404-0120	53414-0120	53405-0120	53415-0120
	4-5/16	5-1/8	110	130	53402-0130	53412-0130	53403-0130	53413-0130	53404-0130	53414-0130	53405-0130	53415-0130
	4-23/32	5-1/2	120	140	53402-0140	53412-0140	53403-0140	53413-0140	53404-0140	53414-0140	53405-0140	53415-0140
	5-1/8	5-29/32	130	150	53402-0150	53412-0150	53403-0150	53413-0150	53404-0150	53414-0150	53405-0150	53415-0150
	5-1/2	6-5/16	140	160	53402-0160	53412-0160	53403-0160	53413-0160	53404-0160	53414-0160	53405-0160	53415-0160
	5-29/32	6-11/16	150	170	53402-0170	53412-0170	53403-0170	53413-0170	53404-0170	53414-0170	53405-0170	53415-0170
	6-5/16	7-3/32	160	180	53402-0180	53412-0180	53403-0180	53413-0180	53404-0180	-	53405-0180	-
	6-11/16	7-15/32	170	190	-	53412-0190	-	53413-0190	-	-	53405-0190	-
	7-3/32	7-7/8	180	200	-	53412-0200	-	53413-0200	-	-	53405-0200	-

¿CUÁL ABRAZADERA ES LA CORRECTA PARA MÍ?

	Resistencia a la Corrosión	Composición del Material	Usos Frecuentes
W2	Requisitos Promedio	Banda y Carcasa de 430 Tornillo de Acero Carbono Recubierto Enchapado	Automotriz - Repuestos de Camiones - Aplicaciones Industriales
W3	Requisitos Medianos	Todo de Acero Inoxidable 430	Equipo Original Automotriz - Aplicaciones Industriales
W4	Requisitos Altos Permeabilidad Magnética Baja	Todo de Acero Inoxidable 304	Conexiones Críticas en Carros tales como Tuberías de Combustible Cerca de Circuitos Electrónicos - Maquinaria para Agricultura - Motocicletas - Letreros - Aplicaciones al Aire Libre Chimeneas de Acero Inoxidable
W5	Requisitos máximos Resistencia al Agua Salada Permeabilidad Magnética Baja	Todo de Acero Inoxidable 316	Cerca de Circuitos Electrónicos - Construcción Naval - Tecnología para Defensa Procesamiento de Alimentos - Plantas para Tratamiento de Aguas Servidas



SUMINISTROS INDUSTRIALES
DIAZ



El Sistema de sujeción de banda y hebilla de la marca IDEAL-TRIDON® ofrece una máxima capacidad de sujeción. Seleccione el ancho de la banda y las opciones de empaque que trabaje mejor para sus aplicaciones de uso ligero y de uso pesado. Perfecta para sujeciones y ataduras resistentes. Valor excepcional – use solo todas las que necesite.

Sistema de Sujeción de Acero Inoxidable

- Banda de larga duración – **Fabricada en USA**
- Las bandas y las hebillas están fabricadas en **acero inoxidable Tipo 201**
- fácil de usar herramienta para tensionar
- Se forma fácilmente para ajustarse a cualquier diámetro
- La aplicación incluye la banda de aislamiento, montura para señalamiento y arnés para cables



CONTENEDORES DE PLÁSTICO PARA BANDAS DE ACERO INOXIDABLE 201

Ancho (pul)	Ancho (mm)	Espesor (pul)	Espesor (mm)	Longitud (pies)	Longitud (m)	Cantidad en Cartón Maestro	Número de Pieza
1/2	12.7	0.030	0.76	100	30.5	2	60080-204B-193
5/8	16	0.030	0.76	100	30.5	2	60080-205G-193
3/4	19	0.030	0.76	100	30.5	2	60080-206R-193

BANDAS ESTÁNDAR DE ACERO INOXIDABLE 201

Ancho (pul)	Ancho (mm)	Espesor (pul)	Espesor (mm)	Longitud (pies)	Longitud (m)	Cantidad en Cartón Maestro	Número de Pieza
1/4	6.4	0.020	0.51	100	30.5	6	60080-0202-194
3/8	9.5	0.025	0.64	100	30.5	6	60080-0203-194
1/2	12.7	0.030	0.76	100	30.5	4	60080-0204-194
5/8	16	0.030	0.76	100	30.5	4	60080-0205-194
3/4	19	0.030	0.76	100	30.5	4	60080-0206-194
1/2	12.7	0.030	0.76	50	15	4	60080-5004-950
5/8	16	0.030	0.76	50	15	4	60080-5005-950
3/4	19	0.030	0.76	50	15	4	60080-5006-950

BANDAS ECONÓMICAS DE ACERO INOXIDABLE 201

Anch (pul)	Ancho (mm)	Espesor (pul)	Espesor (mm)	Longitud (pies)	Longitud (m)	Cantidad en Cartón Maestro	Número de Pieza
1/2	12.7	0.020	0.51	100	30.5	4	60080-0181-200
3/4	19	0.020	0.51	100	30.5	4	60080-0161-200
1/2	12.7	0.020	0.51	200	61	2	60080-0183-200
3/4	19	0.020	0.51	200	61	2	60080-0163-200





HEBILLAS ESTILO OREJA			
Ancho (pul)	Ancho (mm)	Cantidad en Cartón Maestro*	Número de Pieza
1/4	6.4	100	60081-0252-194
3/8	9.5	100	60081-0253-194
1/2	12.7	100	60081-0254-194
5/8	16	100	60081-0255-194
3/4	19	100	60081-0256-194

*Debe de ordenarse por cantidades en Carton Maestro



GRAPAS/HEBILLAS ESTILO ALAS			
Ancho (pul)	Ancho (mm)	Cantidad en Cartón Maestro*	Número de Pieza
1/2	12.7	100	60081-0154-295
3/4	19	100	60081-0156-295

*Debe de ordenarse por cantidades en Carton Maestro



HERRAMIENTA PARA TENSIONAR BANDAS	
Cantidad en Cartón Maestro	Número de Pieza
1	60082-0001-194

Crimpeo – Oreja Sencilla / Abrazaderas y Pinzas de Crimpeo

Las abrazaderas de crimpeo se diseñaron para cubrir las necesidades de líneas de servicio más populares de servicios de agua de polietileno y polibutileno y son perfectas para los sistemas de rocío de jardines, sistemas de riego y la mayoría de las aplicaciones de baja presión.



- Abrazaderas de Grado Marinos
- Todo de Acero inoxidable para una excelente resistencia a la corrosión
- Construcción con Soldadura para una Resistencia superior
- Facil Instalacion
- Sello permanente a prueba de violación a 360 grados
- Compatible con la mayoría de las herramientas de crimpeo

LOCALICE NÚMERO DE PARTE						
Diametro Nominal (pul)	Mínimo (pul)	Máximo (pul)	Mínimo (mm)	Máximo (mm)	Cantidades por Bolsa	Ideal-Tridon 61 Series
3/4	0.669	0.779	17	20	100	611985B
13/16	0.716	0.827	18	21	100	612105B
1	0.898	1.008	23	25	100	612565B
1-1/16	0.945	1.067	24	27	100	612715B
1-1/4	1.122	1.244	29	31	100	613165B
1-5/16	1.181	1.303	30	33	100	613315B
1-3/8	1.240	1.362	32	34	100	613465B
1-5/8	1.492	1.614	38	41	100	614105B
1-11/16	1.551	1.673	40	42	100	614255B
1-7/8	1.787	1.909	46	48	100	614855B

Pinzas de Crimpeo Número de Pieza 6100158

Use para instalar o remover abrazaderas pinchadas/crimpeadas.



COMBO HEX® & TORNILLO SINFIN MILITAR

Las abrazaderas **Combo-Hex**® son las abrazaderas que generalmente eligen los mecánicos profesionales. Especialmente útiles en áreas de difícil acceso, ofrecen un diseño de tornillo exclusivo, con collar de seguridad y ranurado profundo que evita que los destornilladores se resbalen y perforen la pared de la manguera. Las abrazaderas Combo-Hex pueden instalarse con un destornillador, un desarmador de dado o una llave de dado.



Combo Hex Ideal-Tridon 54-0

3/8" Collar de Seguridad Hexagonal Ranurado Profundo

Acero Carbono Recubierto

Carcasa

Inoxidable 200

Ancho de la Banda 9/16"

Inoxidable 200

Instalación a 35 pulg-lbs (4 Nm) para la mayoría de las aplicaciones

Las abrazaderas de **Tornillo Sinfin Militar** son manufacturadas siguiendo la especificación militar MS-35842 y AA-52506C.



Military Worm Drive Ideal-Tridon 632 • Tridon 632

Cabeza Hexagonal de 5/16"

Inoxidable 410

Carcasa

Inoxidable 201

Ancho de la Banda 1/2"

Inoxidable 201

Instalación a 35 pulg-lbs (4 Nm) para la mayoría de las aplicaciones

LOCALICE NÚMERO DE PARTE

Tamaño	Mínimo (pul)	Máximo (pul)	Mínimo (mm)	Máximo (mm)	Ideal-Tridon 54-0	Ideal-Tridon 632 Tridon 632
6	3/8	7/8	10	22	54060	632-006
8	7/16	1	11	25	54080	-
10	1/2	1-1/16	13	27	54100	-
12	1/2	1-1/4	13	32	54120	632-012
16	11/16	1-1/2	18	38	54160	-
20	3/4	1-3/4	19	44	54200	-
24	1	2	25	51	54240	632-024
28	1-1/4	2-1/4	32	57	54280	-
32	1-1/2	2-1/2	38	63	54320	-
36	3/4	2-3/4	19	70	54360	632-036
40	1	3	26	76	54400	-
44	1-1/4	3-1/4	32	83	54440	-
48	2-1/2	3-1/2	64	89	54480*	632-048
52	1-3/4	3-3/4	44	95	54520	-
56	2	4	51	101	54560	-
60	3-5/16	4-1/4	84	108	-	632-060
104	4	7	102	178	-	632-104**

*Mínimo para 54480 es 1-1/2" 38 mm

**Artículo no disponible en almacén



SURELOCK: ENGANCHE RÁPIDO

El diseño de tracción sin fijación de **Surelock** proporciona una instalación rápida y fácil. El diseño de tornillo encapsulado proporciona un enganche y una tensión final sin problemas. La carcasa alargada permite enroscar un 25% más que otros diseños comparables.

Surelock Ideal-Tridon 48

Cabeza Hexagonal de 5/16"

Inoxidable 305

Dos Piezas

Inoxidable 304

Ancho de la Banda 9/16"

Inoxidable 304

Surelock Ideal-Tridon 49

Cabeza Hexagonal de 5/16"

Inoxidable 316

Dos Piezas

Inoxidable 316

Ancho de la Banda 9/16"

Inoxidable 316

Instalación a 40 pulg-lbs (4.5 Nm) para la mayoría de las aplicaciones

LOCALICE NÚMERO DE PARTE						
Tamaño	Mínimo (pul)	Máximo (pul)	Mínimo (mm)	Máximo (mm)	Ideal-Tridon 48	Ideal-Tridon 49
12	1/2	1-1/4	13	32	48012	-
20	3/4	1-3/4	19	44	48020	-
24	3/4	2	19	51	48024	-
28	1	2-1/4	25	57	48028	-
32	1-1/4	2-1/2	32	64	48032	49032
36	7/8	2-3/4	22	70	48036	-
48	1	3-1/2	25	89	48048	-
56	1	4	25	102	48056	-
72	2	5	51	127	48072	49073
80	1-13/16	5-1/2	48	140	48080	49080
88	2	6	51	152	48088	-
104	2	7	51	178	48104	49104
116	1-3/4	7-3/4	44	196	48116	-
128	4-1/4	8-1/2	108	216	48128	49128
152	4	10	102	254	48152	-
180	7-3/4	11-3/4	197	298	48180	49180
188	6-1/4	12-1/4	159	311	48188	-
190	6-3/8	12-3/8	162	314	48190	49190
218	11-3/16	14-5/16	284	359	48218	49218
224	8-1/2	14-1/2	216	368	48224	-
232	9	15	229	381	48232	-
242	12-11/16	15-5/8	323	397	48242	49242
248	2-1/2	16	63	406	48248	-
258	13-11/16	16-5/8	348	422	48258	49258
272	11-1/2	17-1/2	292	445	48272	-
282	15-3/16	18-1/8	386	460	48282	49282
288	12-1/2	18-1/2	318	470	48288	-
306	14-1/16	19-5/8	357	498	48306	49306
312	2-3/8	20	60	508	48312	-

Surelock 48: Tamaño disponible hasta 598. Los tamaños 80 y más grande se envían en su costado sin cerrar.
 Surelock 49: Todos los tamaños se envían en su costado y sin cerrar.

SUMINISTROS INDUSTRIALES DIAZ



7821606595
7821604051
7821610766



contacto@sidadz.com



www.sidadz.com



SNAPLOCK®: LIBERACIÓN RÁPIDA

Las abrazaderas de liberación rápida con tornillo sinfín son útiles para las aplicaciones de sistemas cerrados donde la abrazadera debe liberarse para usarse. El mecanismo de cerrado giratorio del tornillo con la banda hace que se pueda instalar y remover más rápidamente. Todos los alojamientos Snaplock están hechos de acero inoxidable grado 200.



Snaplock Ideal-Tridon 56-0



Cabeza Hexagonal de 5/16"



Acero Carbono Recubierto

Puente



Acero Carbono Recubierto

Ancho de la Banda 9/16"



Inoxidable 200

Snaplock Ideal-Tridon 500 • Tridon 500/LS



Cabeza Hexagonal de 5/16"



Acero Carbono Recubierto

Puente



Inoxidable 410

Ancho de la Banda 1/2"



Inoxidable 200

Snaplock Ideal-Tridon 58-0 • Tridon 58-0



Cabeza Hexagonal de 3/8"



Inoxidable 410

Puente



Inoxidable 410

Ancho de la Banda 9/16"



Inoxidable 200

Snaplock Ideal-Tridon 550 • Tridon 550/LAS



Cabeza Hexagonal de 5/16"



Inoxidable 410

Puente



Inoxidable 410

Ancho de la Banda 1/2"



Inoxidable 200



Instalación a 30 pulg-lbs (3.4 Nm) para la mayoría de las aplicaciones

SUMINISTROS INDUSTRIALES DIAZ

7821606595
7821604051
7821610766



contacto@sidadz.com



www.sidadz.com



LOCALICE NÚMERO DE PARTE

Tamaño	Mínimo (pul)	Máximo (pul)	Mínimo (mm)	Máximo (mm)	Ideal-Tridon 56-0	Ideal-Tridon 500 Tridon 500/LS	Ideal-Tridon 58-0 Tridon 58-0	Ideal-Tridon 550 Tridon 550/LAS
12	1/2	1-1/4	13	32	56120	500-012	5812	-
20	3/4	1-3/4	19	44	56200	500-020	5820	550-020
24	1-1/16	2	27	51	56240	-	5824	-
28	1	2-1/4	25	57	56280	-	5828	550-028
36	1	2-3/4	25	70	56360	500-036	5836	550-036
48	1-1/2	3-1/2	39	89	56480	500-048	5848	550-048
56	1	4	25	102	56560	500-056	5856	550-056
72	2	5	51	127	56720	500-072	5872	550-072
88	2	6	51	152	56880	500-088	5888	550-088
96	3-1/2	6-1/2	89	167	-	500-096	-	550-096
104	2-7/8	7	73	178	56104	500-104	58104	550-104
116	1-3/4	7-3/4	45	197	56116	500-116	58116	550-116
128	1-3/4	8-1/2	45	216	56128	500-128	58128	550-128
136	1-3/4	9	45	228	56136	-	-	550-136
152	2	10	51	254	56152	500-152	58152	550-152
188	2	12-1/4	51	311	56188	500-188	58188	550-188
216	10-3/16	14	259	356	-	500-216	-	550-216
224	2-1/2	14-1/4	64	362	-	-	58224	550-224
232	13-1/8	15	333	381	56232	500-232	-	-
248	1-3/4	16	44	406	-	500-248	-	550-248
258	1-15/16	16-5/8	50	422	56258	500-258	-	-
272	2	17	52	432	56272	-	-	-
280	14-1/4	18	362	457	-	500-280	-	550-280
288	1-13/16	18-1/2	45	470	56288	-	-	-
294	1-7/8	18-3/4	48	479	-	500-294	-	-
312	1-7/8	20	48	508	-	500-312	-	550-312
332	2	21-1/4	51	540	56332	-	58332	-
344	1-3/4	22	44	559	-	500-344	-	550-344
390	18-5/8	25	473	635	-	-	-	550-390

Coples No Hub

Ideal Clamp Products Manufactura coples No Hub que están enlistados o certificados por la mayoría de los cuerpos certificadoros de Plomeros atreves de US y Canada. Visite nuestra página www.idealtridon.com para más información



- Clasico
- Estandar
- Uso Medio MD
- Uso Pesado HD
- 12" y 15"

Las abrazaderas **Wraplock**®, con sus cierres únicos de acero carbono recubierto, se moldean en muchas formas y son adecuadas para aplicaciones especiales.



Wraplock Ideal-Tridon 59-0

Cabeza Hexagonal de 5/16"



Acero Carbono Recubierto

Ancho de la Banda 1/2"



Acero Galvanizado

LOCALICE NÚMERO DE PARTE

Tamaño	Mínimo (pul)	Máximo (pul)	Mínimo (mm)	Máximo (mm)	Longitud de Banda (pul)	Longitud de Banda (mm)	Ideal-Tridon 59-0
12	1	3-1/2	25	89	12	305	5912
15	1	4-1/2	25	114	15	381	5915
18	1	5	25	127	18	457	5918
24	1	7	25	178	24	610	5924
30	1	9	25	229	30	762	5930
48	1	14-1/2	25	368	48	1219	5948

Producto se envía plano, se muestra asegurado solo para propósitos de ilustración.

Las abrazaderas **Lox-On**® son adecuadas para instalaciones que requieran resistencia adicional. Su diseño único nos brinda seguridad de cerrado doble usando un cierre de acero inoxidable grado 301 y una banda de alta tensión para sellado de presiones altas.



Lox-On Ideal-Tridon 69-0

Cabeza Hexagonal de 5/16"



Inoxidable 305

Carcasa



Inoxidable 300

Ancho de la Banda 1/2"



Inoxidable 300 • Sello UPC

LOCALICE NÚMERO DE PARTE

Tamaño	Mínimo (pul)	Máximo (pul)	Mínimo (mm)	Máximo (mm)	Longitud de Banda (pul)	Longitud de Banda (mm)	Ideal-Tridon 69-0
12	11/16	1-1/4	17	32	4-13/16	122	69120
20	11/16	1-3/4	17	44	6-13/32	163	69200
32	11/16	2-5/8	17	67	8-29/32	226	69320
72	1-3/4	5	44	127	16-5/16	414	69720
104	4	7-1/4	102	184	23-5/16	592	69104

Producto se envía plano, se muestra asegurado solo para propósitos de ilustración.



Las abrazaderas **Turn-Key®** ofrecen un diseño innovador y se instalan con un sencillo giro manual sin necesidad de usar herramientas. Remueva la tapa plástica reusable para tener una conexión segura. Algunas aplicaciones incluyen el venteo de secadoras, bolsas de filtros, mangueras de drenaje y arneses de cables.



Turn-Key Ideal-Tridon 5Y/6Y*

Tornillo para Tapar



Acero Carbono Recubierto

Carcasa



Inoxidable 300

Ancho de la Banda 1/2"



Inoxidable 200

*6Y Ancho de Banda 5/16"

LOCALICE NÚMERO DE PARTE						
Tamaño	Mínimo (pul)	Máximo (pul)	Mínimo (mm)	Máximo (mm)	Ideal-Tridon 5Y/6Y*	Ideal-Tridon Empaque de Blister
4	5/16	5/8	8	16	6Y004	‡
6	3/8	7/8	10	22	6Y006	‡
12	1/2	1-1/4	13	32	5Y012	5Y01258*
20	3/4	1-3/4	19	44	5Y020	5Y02058*
28	1-1/4	2-1/4	32	57	5Y028	5Y02858*
36	1-3/4	2-3/4	44	70	5Y036	5Y03658*
48	2-1/2	3-1/2	64	89	5Y048	5Y04858*
64	2-1/2	4-1/2	64	114	5Y064	5Y06458*
‡Micro Surtido: Viene con dos de cada uno de los tamaños 4 y 6						6Y00458
Paquete Surtido de Seis: Viene con uno de cada uno de los tamaños 4, 6, 12, 20, 28, 36						5Y00158

*Viene con 2 abrazaderas paquete blister

Instalador flexible de abrazaderas para manguera ¡Deje de usar el antiguo instalador rígido de tuercas y añada flexibilidad a su trabajo! El eje flexible y la agarradera antideslizante funcionan mejor en lugares difíciles de alcanzar como en los motores de vehículos compactos y aplicaciones de reparación de plomería. El dado es adecuado para las cabezas de tornillo de abrazadera de manguera mini y estándar. Simplemente gire la boquilla al tamaño deseado. Part No. **9999V***



Flexible Hose Clamp Driver Part No. 9999V

1/4" Hex Head



— or —

5/16" Hex Head



*9999V mostrado en empaque No. De parte completo es 800019999058

Las abrazaderas **Revestidas** están diseñadas para usarse con goma de silicona y otras aplicaciones en mangueras blandas. El revestimiento protege la superficie de la manguera y evita que se salga por los orificios de la banda cuando se ajuste la abrazadera.



Lined Ideal-Tridon 65E

	Hexagonal Ranurada de 5/16"	Carcasa	9/16" Banda Revestida
	Inoxidable 300	Inoxidable 300	Inoxidable 300

Lined Ideal-Tridon 615

	Hexagonal Ranurada de 5/16"	Carcasa	1/2" Banda Revestida
	Inoxidable 300	Inoxidable 200	Inoxidable 200

Lined Ideal-Tridon 53-0 • Tridon 613/ET

	Hexagonal Ranurada de 5/16"	Carcasa	1/2" Banda Revestida
	Acero Carbono Recubierto	Inoxidable 200	Inoxidable 200

Lined Ideal-Tridon 67M

	Hexagonal Ranurada de 5/16"	Carcasa	1/2" Banda Revestida
	Inoxidable 316	Inoxidable 316	Inoxidable 316



Instalación a 35 pulg-lbs (4 Nm) para la mayoría de las aplicaciones



LOCALICE NÚMERO DE PARTE

Tamaño	Mínimo (pul)	Máximo (pul)	Mínimo (mm)	Máximo (mm)	Ideal-Tridon 65E	Ideal-Tridon 615	Ideal-Tridon 53-0	Tridon 613/ET	Ideal-Tridon 67M
6	1/2	7/8	13	22	6506E	615-006	53060	613-006	N/A
8	5/8	1	16	25	6508E	615-008	53080	613-008	6708M
10	11/16	1-1/16	17	27	6510E	615-010	53100	613-010	6710M
12	11/16	1-1/4	17	32	6512E	615-012	53120	613-012	6712M
16	3/4	1-1/2	19	38	6516E	615-016	53160	613-016	6716M
20	1	1-3/4	25	44	6520E	615-020	53200	613-020	6720M
24	1-1/16	2	27	51	6524E	615-024	53240	613-024	6724M
28	1-5/16	2-1/4	34	57	6528E	615-028	53280	613-028	6728M
32	1-9/16	2-1/2	40	64	6532E	615-032	53320	613-032	6732M
36	1-13/16	2-3/4	46	70	6536E	615-036	53360	613-036	6736M
40	2-1/16	3	52	76	6540E	615-040	53400	613-040	6740M
44	2-5/16	3-1/4	59	82	6544E	615-044	53440	613-044	6744M
48	2-9/16	3-1/2	65	89	6548E	615-048	53480	613-048	6748M
52	2-13/16	3-3/4	72	95	6552E	615-052	53520	613-052	6752M
56	3-1/16	4	78	100	6556E	615-056	53560	613-056	6756M
60	3-9/16	4-1/4	84	108	6560E	615-060	53600	613-060	6760M
64	3-9/16	4-1/2	91	114	6564E	615-064	53640	613-064	6764M
72	4-1/16	5	103	127	6572E	615-072	53720	613-072	6772M
80	4-9/16	5-1/2	116	140	-	615-080	-	-	-
88	5	6	128	152	-	-	-	-	6788M
96	5-1/2	6-1/2	141	165	-	-	-	-	6796M



SUMINISTROS INDUSTRIALES DÍAZ

DIMENSIONES DEL PRODUCTO

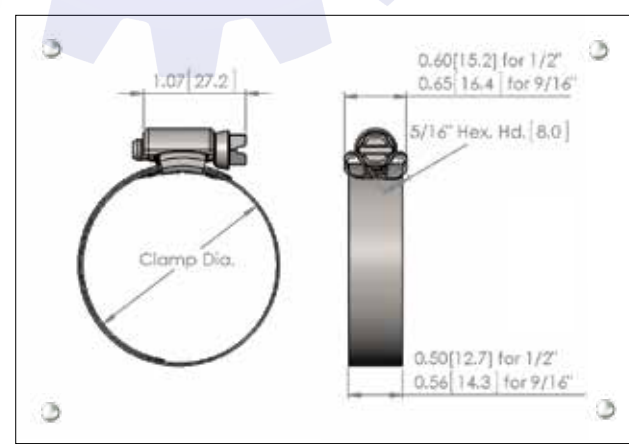

7821606595
7821604051
7821610766



contacto@sidadz.com







www.sidadz.com



Las abrazaderas de alta resistencia **Pow'r-Gear®**, están diseñadas para aplicarse cuando se requiere resistencia a vibraciones altas y escapes como en el caso de la maquinaria industrial y agrícola, equipo pesado, y motores para equipo todo terreno. La abrazadera Pow'r-Gear tiene una banda extra ancha de 5/8" y un alojamiento ancho que permite un máximo acoplamiento entre las roscas del tornillo y la banda. Estas abrazaderas están diseñadas para alcanzar altos niveles de tensión en la banda sirviendo para aplicaciones que requieren de un sellado superior.



Pow'r-Gear Ideal-Tridon 60 • Tridon M850



Cabeza Hexagonal de 5/16"	Carcasa	Ancho de la Banda 5/8"
		
Inoxidable 410	Inoxidable 300	Inoxidable 300



Pow'r-Gear Ideal-Tridon 6P



Cabeza Hexagonal de 5/16"	Carcasa	Ancho de la Banda 5/8"
		
Inoxidable 305	Inoxidable 300	Inoxidable 300



Pow'r-Gear Ideal-Tridon 6L • Tridon M843



Cabeza Hexagonal de 5/16"	Carcasa	5/8" Banda Revestida
		
Inoxidable 410	Inoxidable 300	Inoxidable 300



Pow'r-Gear Ideal-Tridon 6M



Cabeza Hexagonal de 5/16"	Carcasa	5/8" Banda Revestida
		
Inoxidable 305	Inoxidable 300	Inoxidable 300

Pow'r-Gear Ideal-Tridon 6X



Cabeza Hexagonal de 5/16"	Carcasa	Ancho de la Banda 5/8"
		
Inoxidable 410	Inoxidable 300	Inoxidable 300



Instalación a 75-90 pulg-lbs (8.5-10 Nm) para la mayoría de las aplicaciones



LOCALICE NÚMERO DE PARTE

Tamaño	Mínimo (pul)	Máximo (pul)	Mínimo (mm)	Máximo (mm)	Ideal-Tridon 60	Tridon M850	Ideal-Tridon 6P	Ideal-Tridon 6L	Tridon M843	Ideal-Tridon 6M
175	1	1-3/4	25	45	60175	850-175	6P175	6L175	843-175	6M175
212	1-1/4	2-1/8	32	54	60200	850-200	6P200	6L200	843-200	6M200
262	1-3/4	2-5/8	45	66	60250	850-250	6P250	6L250	843-250	6M250
312	2-1/4	3-1/8	57	79	60300	850-300	6P300	6L300	843-300	6M300
362	2-3/4	3-5/8	70	92	60350	850-350	6P350	6L350	843-350	6M350
412	3-1/4	4-1/8	83	105	60400	850-400	6P400	6L400	843-400	6M400
462	3-3/4	4-5/8	95	117	60450	850-450	6P450	6L450	843-450	6M450
512	4-1/4	5-1/8	108	130	60500	850-500	6P500	6L500	843-500	6M500
562	4-3/4	5-5/8	121	143	60550	850-550	6P550	6L550	843-550	6M550
612	5-1/4	6-1/8	133	155	60600	850-600	6P600	6L600	843-600	6M600
662	5-3/4	6-5/8	146	168	60650	850-650	6P650	6L650	843-650	6M650
712	6-1/4	7-1/8	159	181	60700	850-700	6P700	6L700	843-700	6M700
762	6-3/4	7-5/8	172	193	60750	850-750	6P750	6L750	843-750	6M750
812	7-1/4	8-1/8	184	206	60800	850-800	6P800	6L800	843-800	6M800
862	7-3/4	8-5/8	197	219	60850	850-850	6P850	6L850	843-850	6M850
912	8-1/4	9-1/8	210	232	60900	850-900	6P900	6L900	843-900	6M900

Sabía Usted Que...

Las abrazaderas Pow'r-Gear Serie 6X tienen orificios extra en la banda brindando un mayor rango de trabajo de manera que cinco tamaños cubren diámetros de sujeción desde 1-1/4" hasta 10-1/8". Esto reduce su inventario sin comprometer su capacidad de cubrir muchas aplicaciones. Además, las abrazaderas Pow'r-Gear alcanzan una tensión en la banda de más de 800 lbs. cuando se aplica un torque de 150 lbs. ¡Esto es más del doble del poder de sujeción de las abrazaderas convencionales!

LOCALICE NÚMERO DE PARTE

Tamaño	Mínimo (pul)	Máximo (pul)	Mínimo (mm)	Máximo (mm)	Ideal-Tridon 6X
262	1-1/4	2-5/8	32	66	6X200
412	2	4-1/8	51	105	6X300
612	4	6-1/8	102	155	6X400
912	6	9-1/8	153	231	6X500
1012	7	10-1/8	178	257	6X600

Tamaños adicionales disponibles



PERNO TIPO T: DIAMETROS MINIMOS

Abrazaderas con Pernos Tipo T una presión de sellado uniforme para lograr un sello confiable. Diseñadas para uso en aplicaciones de alta vibración y gran diámetro, comunes en aplicaciones para camiones pesados, maquinaria industrial, equipo para todo terreno, riego agrícola y maquinaria. Cuenta con una banda de acero inoxidable de 3/4" ó 7/8" de ancho, dependiendo del tamaño pedido, y esta soldada para lograr confiabilidad.

Perno Tipo T Estándar Ideal-Tridon 30010



Perno Tipo T 1/4"



Acero Carbono Recubierto

Tuerca Hexagonal de 7/16"



Acero Carbono Recubierto con Inserto en Nilón

Banda 3/4"



Inoxidable 300

Puente de 3/4"



Inoxidable 300

Muñón



Acero Carbono Recubierto

Perno Tipo T Estándar Ideal-Tridon 30011

Perno Tipo T 1/4"



Inoxidable 300

Tuerca Hexagonal de 7/16"



Inoxidable 300 con Inserto en Nilón

Banda 3/4"



Inoxidable 300

Puente de 3/4"



Inoxidable 300

Muñón



Inoxidable 300

Perno Tipo T, con Puente Tipo Canal Ideal-Tridon 30020



Perno Tipo T 1/4"



Acero Carbono Recubierto

Tuerca Hexagonal de 7/16"



Acero Carbono Recubierto con Inserto en Nilón

Banda 3/4"



Inoxidable 300

Puente de 3/4"



Inoxidable 300

Muñón



Acero Carbono Recubierto

Perno Tipo T, con Puente Tipo Canal Ideal-Tridon 30021

Perno Tipo T 1/4"



Inoxidable 300

Tuerca Hexagonal de 7/16"



Inoxidable 300 con Inserto en Nilón

Banda 3/4"



Inoxidable 300

Puente de 3/4"



Inoxidable 300

Muñón



Inoxidable 300

Nota: Ancho de banda de 7/8" y opciones individuales sobre pedido



Instalación a 75 pulg-lbs (8.5 Nm) para la mayoría de las aplicaciones



SUMINISTROS INDUSTRIALES DIAZ



LOCALICE NÚMERO DE PARTE

Tamaño					Perno Tipo T Estándar		Puente Tipo Canal	
	Mínimo (pul)	Máximo (pul)	Mínimo (mm)	Máximo (mm)	Ideal-Tridon 30010*	Ideal-Tridon 30011*	Ideal-Tridon 30020	Ideal-Tridon 30021
138	1.38	1.57	35.1	39.9	30010-0138	30011-0138	30020-0138	30021-0138
150	1.50	1.69	38.1	42.9	30010-0150	30011-0150	30020-0150	30021-0150
163	1.63	1.88	41.3	47.8	30010-0163	30011-0163	30020-0163	30021-0163
175	1.75	2.00	44.5	50.8	30010-0175	30011-0175	30020-0175	30021-0175
188	1.88	2.19	47.6	55.6	30010-0188	30011-0188	30020-0188	30021-0188
200	2.00	2.31	50.8	58.7	30010-0200	30011-0200	30020-0200	30021-0200
213	2.13	2.44	54.1	62.0	30010-0213	30011-0213	30020-0213	30021-0213
225	2.25	2.56	57.2	65.0	30010-0225	30011-0225	30020-0225	30021-0225
238	2.38	2.69	60.3	68.3	30010-0238	30011-0238	30020-0238	30021-0238
250	2.50	2.81	63.5	71.4	30010-0250	30011-0250	30020-0250	30021-0250
263	2.63	2.94	66.7	74.7	30010-0263	30011-0263	30020-0263	30021-0263
275	2.75	3.06	69.9	77.7	30010-0275	30011-0275	30020-0275	30021-0275
288	2.88	3.19	73.0	81.0	30010-0288	30011-0288	30020-0288	30021-0288
300	3.00	3.31	76.2	84.1	30010-0300	30011-0300	30020-0300	30021-0300
313	3.13	3.44	79.4	87.4	30010-0313	30011-0313	30020-0313	30021-0313
325	3.25	3.56	82.6	90.4	30010-0325	30011-0325	30020-0325	30021-0325
338	3.38	3.69	85.7	93.7	30010-0338	30011-0338	30020-0338	30021-0338
350	3.50	3.81	88.9	96.8	30010-0350	30011-0350	30020-0350	30021-0350
363	3.63	3.94	92.1	100.1	30010-0363	30011-0363	30020-0363	30021-0363
375	3.75	4.06	95.3	103.1	30010-0375	30011-0375	30020-0375	30021-0375
400	4.00	4.31	101.6	109.5	30010-0400	30011-0400	30020-0400	30021-0400
425	4.25	4.56	108.0	115.8	30010-0425	30011-0425	30020-0425	30021-0425
450	4.50	4.81	114.3	122.2	30010-0450	30011-0450	30020-0450	30021-0450
475	4.75	5.06	120.7	128.5	30010-0475	30011-0475	30020-0475	30021-0475
500	5.00	5.31	127.0	134.9	30010-0500	30011-0500	30020-0500	30021-0500
525	5.25	5.56	133.4	141.2	30010-0525	30011-0525	30020-0525	30021-0525
550	5.50	5.81	139.7	147.6	30010-0550	30011-0550	30020-0550	30021-0550
575	5.75	6.06	146.1	153.9	30010-0575	30011-0575	30020-0575	30021-0575
600	6.00	6.31	152.4	160.3	30010-0600	30011-0600	30020-0600	30021-0600
625	6.25	6.56	158.8	166.6	30010-0625	30011-0625	30020-0625	30021-0625
650	6.50	6.81	165.1	173.0	30010-0650	30011-0650	30020-0650	30021-0650
675	6.75	7.06	171.5	179.3	30010-0675	30011-0675	30020-0675	30021-0675
700	7.00	7.31	177.8	185.7	30010-0700	30011-0700	30020-0700	30021-0700
725	7.25	7.56	184.2	192.0	30010-0725	30011-0725	30020-0725	30021-0725
750	7.50	7.81	190.5	198.4	30010-0750	30011-0750	30020-0750	30021-0750
775	7.75	8.06	196.9	204.7	30010-0775	30011-0775	30020-0775	30021-0775
800	8.00	8.31	203.2	211.1	30010-0800	30011-0800	30020-0800	30021-0800
825	8.25	8.56	209.6	217.4	30010-0825	30011-0825	30020-0825	30021-0825
850	8.50	8.81	215.9	223.8	30010-0850	30011-0850	30020-0850	30021-0850

Tamaños adicionales disponibles sobre pedido.
 * Disponible con código de barras (individualmente)



SUMINISTROS INDUSTRIALES DIAZ



PERNO TIPO T: DIAMETROS NOMINALES

Abrazaderas T Bolt de Tamaño Nominal proveen un sello a una presión uniforme para un sellado positivo y confiable. Diseñada para uso en aplicaciones de alta vibración y de gran diámetro, comúnmente en camiones pesados, maquinaria industrial, equipo para uso en caminos, irrigación en agricultura y maquinaria. Fácil de intercambiar con numero de partes de los competidores.



30050



Perno Tipo T 1/4"



Acero Carbono Recubierto

Tuerca Hexagonal de 7/16"



Acero Carbono Recubierto con Inserto en Nílon

Ancho de la Banda 3/4"



Inoxidable 300

Puente de 3/4"



Inoxidable 300

Muñón



Acero Carbono Recubierto

Perno Tipo T Estándar

30051

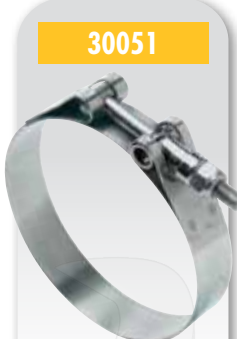

Perno Tipo T 1/4"



Inoxidable 300

Tuerca Hexagonal de 7/16"



Inoxidable 300 con Inserto en Nílon

Ancho de la Banda 3/4"



Inoxidable 300

Puente de 3/4"



Inoxidable 300

Muñón



Inoxidable 300

Perno Tipo T Estándar

LOCALICE NÚMERO DE PARTE

Diametros Nominales (pul)	Diametros Nominales (mm)	Min (pul)	Max (pul)	Min (mm)	Max (mm)	Ideal-Tridon 30050	Ideal-Tridon 30051
1.31	33.3	1.25	1.41	31.8	35.7	30050-0131	30051-0131
1.50	38.1	1.34	1.56	34.1	39.7	30050-0150	30051-0150
1.63	41.4	1.47	1.69	37.4	43.0	30050-0163	30051-0163
1.75	44.5	1.59	1.81	40.5	46.0	30050-0175	30051-0175
1.88	47.8	1.72	1.94	43.8	49.3	30050-0188	30051-0188
2.00	50.8	1.84	2.06	46.8	52.4	30050-0200	30051-0200
2.12	53.8	1.96	2.18	49.9	55.4	30050-0212	30051-0212
2.25	57.2	2.09	2.31	53.2	58.7	30050-0225	30051-0225
2.38	60.5	2.22	2.44	56.5	62.0	30050-0238	30051-0238
2.50	63.5	2.34	2.56	59.5	65.1	30050-0250	30051-0250
2.56	65.0	2.33	2.62	59.1	66.6	30050-0256	30051-0256
2.63	66.8	2.40	2.69	60.9	68.4	30050-0263	30051-0263
2.75	69.9	2.52	2.81	63.9	71.4	30050-0275	30051-0275
2.88	73.2	2.65	2.94	67.2	74.7	30050-0288	30051-0288
3.00	76.2	2.77	3.06	70.3	77.8	30050-0300	30051-0300
3.12	79.2	2.87	3.18	72.8	80.8	30050-0312	30051-0312
3.25	82.6	3.02	3.31	76.6	84.1	30050-0325	30051-0325
3.50	88.9	3.27	3.56	83.0	90.5	30050-0350	30051-0350
3.62	91.9	3.39	3.68	86.0	93.5	30050-0362	30051-0362
3.75	95.3	3.52	3.81	89.3	96.8	30050-0375	30051-0375
3.82	97.0	3.59	3.88	91.1	98.6	30050-0382	30051-0382
4.00	101.6	3.77	4.06	95.7	103.2	30050-0400	30051-0400
4.25	108.0	4.02	4.31	102.0	109.5	30050-0425	30051-0425
4.50	114.3	4.27	4.56	108.4	115.9	30050-0450	30051-0450
4.75	120.7	4.52	4.81	114.7	122.2	30050-0475	30051-0475
5.00	127.0	4.77	5.06	121.1	128.6	30050-0500	30051-0500
5.25	133.4	5.02	5.31	127.4	134.9	30050-0525	30051-0525
5.50	139.7	5.27	5.56	133.8	141.3	30050-0550	30051-0550
5.75	146.1	5.52	5.81	140.1	147.6	30050-0575	30051-0575
6.00	152.4	5.77	6.06	146.5	154.0	30050-0600	30051-0600
6.25	158.8	6.02	6.31	152.8	160.3	30050-0625	30051-0625
6.50	165.1	6.27	6.56	159.2	166.7	30050-0650	30051-0650
6.75	171.5	6.52	6.81	165.5	173.0	30050-0675	30051-0675
7.00	177.8	6.77	7.06	171.9	179.4	30050-0700	30051-0700
7.25	184.2	7.02	7.31	178.2	185.7	30050-0725	30051-0725
7.50	190.5	7.27	7.56	184.6	192.1	30050-0750	30051-0750
8.00	203.2	7.77	8.06	197.3	204.8	30050-0800	30051-0800
8.25	209.6	8.02	8.31	203.6	211.1	30050-0825	30051-0825
8.50	215.9	8.27	8.56	210.0	217.5	30050-0850	30051-0850
8.88	225.6	8.65	8.94	219.6	227.1	30050-0888	30051-0888
9.00	228.6	8.77	9.06	222.7	230.2	30050-0900	30051-0900
9.50	241.3	9.27	9.56	235.4	242.9	30050-0950	30051-0950
10.00	254.0	9.77	10.06	248.1	255.6	30050-1000	30051-1000
10.88	276.4	10.65	10.94	270.4	277.9	30050-1088	30051-1088
12.00	304.8	11.77	12.06	298.9	306.4	30050-1200	30051-1200
12.88	327.2	12.65	12.94	321.2	328.7	30050-1288	30051-1288



PERNO TIPO T CON RESORTE DE CARGA

Perno Tipo T, con Resorte de Carga éstas abrazaderas proporcionan una presión de sellado uniforme para lograr un sello confiable. Diseñadas para uso en aplicaciones de alta vibración y gran diámetro en aplicaciones comunes para camiones pesados, maquinaria industrial, equipo para todo terreno, riego agrícola y maquinaria. Cuenta con una banda de acero inoxidable de 3/4" de ancho, soldada para lograr confiabilidad y con resorte de compensación.

Perno Tipo T Con Resorte De Carga Ideal-Tridon 30030



Perno Tipo T 1/4"



Acero Carbono Recubierto

Tuerca Hexagonal de 7/16"



Acero Carbono Recubierto con Inserto en Nílon

Ancho de la Banda 3/4"



Inoxidable 300

Puente de 3/4"



Inoxidable 300

Muñón



Acero Carbono Recubierto

Resorte



Acero

LOCALICE NÚMERO DE PARTE					Ideal-Tridon 30030
Tamaño	Mínimo (pul)	Máximo (pul)	Mínimo (mm)	Máximo (mm)	
225	2.250	2.563	57.2	65.1	30030-0225
275	2.750	3.063	69.9	77.8	30030-0275
300	3.000	3.313	76.2	84.1	30030-0300
306	3.063	3.375	77.8	85.7	30030-0306
313	3.125	3.438	79.4	87.3	30030-0313
325	3.250	3.563	82.6	90.5	30030-0325
338	3.375	3.688	85.7	93.7	30030-0338
350	3.500	3.813	88.9	96.8	30030-0350
356	3.563	3.875	90.5	98.4	30030-0356
363	3.625	3.938	92.1	100.0	30030-0363
375	3.750	4.063	95.3	103.2	30030-0375
400	4.000	4.313	101.6	109.5	30030-0400
406	4.063	4.375	103.2	111.1	30030-0406
425	4.250	4.563	108.0	115.9	30030-0425
450	4.500	4.813	114.3	122.2	30030-0450
456	4.563	4.875	115.9	123.8	30030-0456
475	4.750	5.063	120.7	128.6	30030-0475
500	5.000	5.313	127.0	134.9	30030-0500
506	5.063	5.375	128.6	136.5	30030-0506
525	5.250	5.563	133.4	141.3	30030-0525
550	5.500	5.813	139.7	147.6	30030-0550
575	5.750	6.063	146.1	154.0	30030-0575
625	6.250	6.563	158.8	166.7	30030-0625
650	6.500	6.813	165.1	173.0	30030-0650
750	7.500	7.813	190.5	198.4	30030-0750



Instalación a 75 pulg-lbs (8.5 Nm) para la mayoría de las aplicaciones

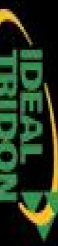

ABRAZADERAS CON INSERTOS EN FORMA DE V

Las **abrazaderas con insertos en Forma de V** sellan conexiones en uniones con bridas. Las aplicaciones típicas incluyen alojamientos de filtro, sistemas de turbocompresión, sistemas de escape y aplicaciones industriales donde se requiere una conexión con bridas. Los insertos en V se pueden manufacturar con las especificaciones de los equipos originales y se hacen por pedido. Se disponen de aleaciones adicionales para ambientes severos.



Abrazaderas con Insertos en Forma de V



Perno Tipo T 1/4"



Inoxidable 410

Tuerca Hexagonal de 7/16"



Inoxidable 300

Banda con Inserto en V



Inoxidable 300

Muñon



Inoxidable 300

LOCALICE NÚMERO DE PARTE												Ideal-Tridon 24000
Diametros Nominales (pul)	Diametros Nominales (pul)	Dim "A" (pul)	Dim "A" (mm)	Dim "B" (pul)	Dim "B" (mm)	Dim "C" (pul)	Dim "C" (mm)	Dim "D" (pul)	Dim "D" (mm)	Dim "E" (pul)	Dim "E" (mm)	
2.88	73.2	0.060	1.52	0.207	5.26	0.281	7.14	0.035	0.89	0.750	19.05	24000-0288
3.21	81.5	0.050	1.27	0.262	6.65	0.141	3.58	0.035	0.89	0.750	19.05	24000-0321
3.82	97.0	0.077	1.96	0.207	5.26	0.281	7.14	0.040	1.02	0.875	22.23	24000-0382
4.06	103.1	0.077	1.96	0.239	6.07	0.281	7.14	0.050	1.27	0.875	22.23	24000-0406
4.13	104.9	0.050	1.27	0.262	6.65	0.141	3.58	0.035	0.89	0.750	19.05	24000-0413
4.19	106.4	0.050	1.27	0.400	10.16	0.281	7.14	0.040	1.02	0.875	22.23	24000-0419
4.25	108.0	0.050	1.27	0.400	10.16	0.281	7.14	0.040	1.02	0.875	22.23	24000-0425
4.50	114.3	0.077	1.96	0.207	5.26	0.281	7.14	0.040	1.02	0.875	22.23	24000-0450
4.61	117.1	0.050	1.27	0.156	3.96	0.281	5.54	0.035	0.89	0.750	19.05	24000-0461
4.75	120.7	0.050	1.27	0.400	10.16	0.281	7.14	0.079	2.01	0.875	22.23	24000-0475
4.81	122.2	0.077	1.96	0.207	5.26	0.281	7.14	0.040	1.02	0.875	22.23	24000-0481
4.94	125.5	0.050	1.27	0.181	4.60	0.281	7.14	0.035	0.89	0.750	19.05	24000-0494
5.25	133.4	0.050	1.27	0.262	6.65	0.141	3.58	0.035	0.89	0.750	19.05	24000-0525
5.81	147.6	0.077	1.96	0.207	5.26	0.281	7.14	0.062	1.57	0.875	22.23	24000-0581
5.88	149.4	0.050	1.27	0.400	10.16	0.281	7.14	0.079	2.01	0.875	22.23	24000-0588
5.92	150.4	0.090	2.29	0.293	7.44	0.296	7.52	0.050	1.27	0.875	22.23	24000-0592

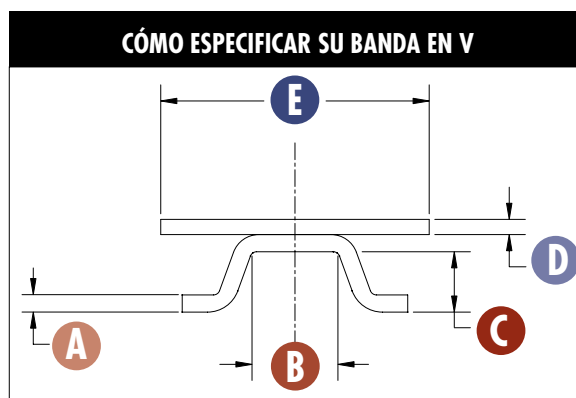

Se dispone de **abrazadera con insertos en Forma de V** especiales para aplicaciones de OE (Equipo Original) como es la Univee y la Estampado G (diseño clamshell) . **Contacte al representante de ventas de IDEAL-TRIDON para ayudarle con sus pedidos con requisitos especiales para su aplicación específica.**

Abrazadera con Perno Tipo T con Insertos en Forma de V, Univee



Tipo en T 1/4"



Inoxidable 420

Banda con Inserto en V



Inoxidable 300

Muñon



Inoxidable 300

Abrazadera Tipo V, Estampado G (Diseño Clamshell)



Perno de Cabeza Redonda M6



Inoxidable 300

Banda con Inserto en V



Inoxidable 300



Instalación a 90 pulg-lbs (10.2 Nm) para la mayoría de las aplicaciones

Tapas de Seguridad para Abrazaderas



- Protege a los instaladores de cortes y raspaduras
- Protege a los materiales aledaños de abrasión y perfiles filosos
- Provee un aspecto y acabado, limpio y profesional en cualquier aplicación
- Se instala rapido y facil

LOCALICE NÚMERO DE PARTE

Tamaño (pul)	Tamaño (mm)	Cantidad por Bolsa	Cantidad en Cartón Maestro	Número de Pieza
1/2	13	25	40 bags per box*	99999-0012-203
1/2	13	100	10 bags per box*	99999-0012-207
9/16	14	25	40 bags per box*	99999-0916-203
9/16	14	100	10 bags per box*	99999-0916-207

*Se debe ordenar en cantidades de Carton Maestro



SUMINISTROS
INDUSTRIALES
DIAZ

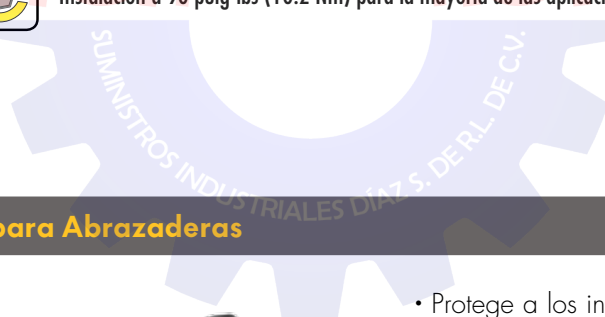

7821606595
7821604051
7821610766



contacto@sidadz.com



www.sidadz.com



Las abrazaderas **Flex-Gear®** usan un resorte tipo Belleville diseñado para eliminar la fuga de "flujo frío". El mismo se ajusta con la manguera y el conector para mantener tensión constante en la conexión, eliminando así fugas. Es una aplicación excelente para aplicaciones de temperatura fluctuante y compensación termal. **Características y Beneficios:** resorte concavo y la construcción de la abrazadera están hechas para responder a fluctuaciones constantes de temperatura. Los resortes formados con precisión, de mayor tamaño y mayor grosor, brindan mayor tensión en la banda y ajuste para lograr un sello más confiable. Los forros interiores protegen contra rupturas en la superficie de la manguera.



SUMINISTROS INDUSTRIALES DIAZ



Flex-Gear Ideal-Tridon 43



Cabeza Hexagonal de 5/16"



Acero Carbono Recubierto

Carcasa



Inoxidable 300

Resorte



Inoxidable 300

9/16" Banda Revestida



Inoxidable 300

Flex-Gear Ideal-Tridon 47



Cabeza Hexagonal de 5/16"



Inoxidable 410

Carcasa



Inoxidable 300

Resorte



Inoxidable 300

9/16" Banda Revestida



Inoxidable 300



Instalación a 50 pulg-lbs (5.6 Nm) para la mayoría de las aplicaciones

Flex-Gear HD Ideal-Tridon 41



Cabeza Hexagonal de 3/8"



Acero Carbono Recubierto

Carcasa



Inoxidable 300

Resorte



Inoxidable 300

5/8" Banda Revestida



Inoxidable 300

Flex-Gear HD Ideal-Tridon 45



Cabeza Hexagonal de 3/8"



Inoxidable 410

Carcasa



Inoxidable 300

Resorte



Inoxidable 300

5/8" Banda Revestida



Inoxidable 300



Instalación a 75 pulg-lbs (8.5 Nm) para la mayoría de las aplicaciones

LOCALICE NÚMERO DE PARTE

Tamaño	Mínimo (pul)	Máximo (pul)	Mínimo (mm)	Máximo (mm)	Ideal-Tridon 43	Ideal-Tridon 47
10	9/16	1-1/16	14	27	43010	47010
12	5/8	1-1/4	16	32	43012	47012
16	13/16	1-1/2	21	38	43016	47016
20	13/16	1-3/4	20	44	43020	47020
24	1-1/16	2	27	51	43024	47024
28	1-5/16	2-1/4	33	57	43028	47028
32	1-9/16	2-1/2	40	63	43032	47032
36	1-13/16	2-3/4	46	70	43036	47036
40	2-1/16	3	52	76	43040	47040
44	2-5/16	3-1/4	59	82	43044	47044
48	2-9/16	3-1/2	65	89	43048	47048

LOCALICE NÚMERO DE PARTE

Tamaño	Mínimo (pul)	Máximo (pul)	Mínimo (mm)	Máximo (mm)	Ideal-Tridon 41	Ideal-Tridon 45
175	1	1-3/4	25	45	41175	45175
212	1-1/4	2-1/8	32	54	41200	45200
262	1-3/4	2-5/8	45	67	41250	45250
312	2-1/4	3-1/8	57	79	41300	45300
362	2-3/4	3-5/8	70	92	41350	45350
412	3-1/4	4-1/8	83	105	41400	45400
462	3-3/4	4-5/8	95	117	41450	45450
512	4-1/4	5-1/8	108	130	41500	45500
562	4-3/4	5-5/8	121	143	41550	45550
612	5-1/4	6-1/8	133	155	41600	45600
662	5-3/4	6-5/8	146	168	41650	45650
712	6-1/4	7-1/8	159	181	41700	45700
762	6-3/4	7-5/8	172	193	41750	45750
812	7-1/4	8-1/8	184	206	41800	45800
862	7-3/4	8-5/8	197	219	41850	45850
912	8-1/4	9-1/8	210	232	41900	45900



Sabía Usted Que...

IDEAL-TRIDON ofrece una nueva generación de abrazaderas inteligentes, que son más livianas y que pueden ser utilizadas en vez de las abrazaderas más pesadas Flex-Gear. Si para usted es primordial un diseño compacto con peso reducido, entonces revise nuestra lista de abrazadoras SmartSeal en la página 6. Las abrazaderas SmartSeal representan lo máximo en la tecnología de sellado de juntas, y su estructura ultra compacta es perfecta para las aplicaciones de alta vibración y ciclos térmicos.



IDEAL-TRIDON ofrece una gran variedad de opciones de mostradores de abrazaderas para que los exhiba directamente a sus clientes. Seleccione de tres diferentes estantes y muestre sus abrazaderas en su mostrador. ○ también, pinzas y conviértalo en un mostrador de repisa.

Centro de Ganancia de Abrazaderas de 130 Piezas



LOCALICE NÚMERO DE PARTE

TAMAÑOS Y CANTIDADES POR PAQUETE

Descripción	Micro 4	Micro 6	Tamaño 10	Tamaño 12	Tamaño 20	Tamaño 28	Tamaño 36	Número de Pieza
Sólo 130 Piezas Estante	-	-	-	-	-	-	-	2671001
Surtido de la Automociónt + Estante	20	20	10	20	20	20	20	99903-0520-051
Surtido de la Automociónt Sólo Abrazaderas	20	20	10	20	20	20	20	99902-0520-051
Industriales/Automociónt Surtido + Estante	20	20	10	20	20	20	20	99903-0570-051
Industriales/Automociónt Sólo Pinzas Surtido	20	20	10	20	20	20	20	99902-0570-051
Surtido de Hardware + Estante	20	20	10	20	20	20	20	99903-0671-053
Surtido de Hardware Sólo Abrazaderas	20	20	10	20	20	20	20	99902-0671-053

Centro de Ganancia de Abrazaderas de 130 Piezas

Tiene capacidad para 130 abrazaderas con múltiples opciones de surtidos.
15" H x 14" W x 5" D

Abraze sus Ventas con los Centros de Ganancias de Abrazaderas

- IDEAL-TRIDON exclusivo
- Diseños llamativos a simple vista
- Construidos de metal resistente y anuncios de estireno durables
- Mercancía visible promueve eficiencia y control organizado de inventarios
- Pre-ensamblado
- Para mesa de mostrador o mostrador en perfo-board



Exhibidor Grande para Abrazaderas

Número de Pieza: **2674001**

Contiene 250 abrazaderas de múltiples opciones de surtido.
24-1/8" H x 21-1/8" W x 6-13/16" D



Exhibidor Pequeño para Abrazaderas

Número de Pieza: **2673001**

Contiene 130 abrazaderas de múltiples opciones de surtido.
17-3/8" H x 16" W x 6-13/16" D



Opciones Varias

67-4	67-1	57-0	68-0	50-0
Cabeza Hexagonal de 5/16"	Cabeza Hexagonal de 5/16"	Cabeza Hexagonal de 5/16"	Cabeza Hexagonal de 5/16"	Cabeza Hexagonal de 5/16"
Inoxidable 300	Inoxidable 410	Acero Carbono Recubierto	Inoxidable 410	Acero Carbono Recubierto
UPC Shield	Carcasa	Carcasa	Carcasa	Carcasa
Inoxidable 300	Inoxidable 200	Inoxidable 200	Inoxidable 200	Inoxidable 200
Banda 1/2" Width	Banda 1/2" Width	Banda 1/2" Width	Banda 9/16" Width	Banda 9/16" Width
Inoxidable 300	Inoxidable 200	Inoxidable 200	Inoxidable 200	Inoxidable 200
1/2" Hy-Gear	1/2" Hy-Gear	1/2" Hy-Gear	9/16" Hy-Gear	9/16" Hy-Gear

TAMAÑOS Y CANTIDADES POR PAQUETE

	Micro 4	Micro 6	Tamaño 10	Tamaño 12	Tamaño 20	Tamaño 28	Tamaño 36
Exhibidor Pequeño para Abrazaderas + 250 Piezas	40	40	40	40	30	30	30
Exhibidor Grande para Abrazaderas + 450 Piezas	70	70	60	60	70	60	60
Exhibidor Grande para Abrazaderas + 600 Piezas	100	100	80	80	80	80	80

LOCALICE NÚMERO DE PARTE

	Anaquel Pequeño Solo para Abrazaderas: 2673001		Anaquel Grande Solo para Abrazaderas: 2674001		
	67-4	67-1	57-0	68-0	50-0
250 Piezas + Exhibidor Pequeño	99903-1674-051	99903-1671-051	99903-1570-051	99903-1680-051	99903-1500-051
450 Piezas + Exhibidor Grande	99903-2674-051	99903-2671-051	99903-2570-051	99903-2680-051	99903-2500-051
600 Piezas + Exhibidor Grande	99903-3674-051	99903-3671-051	99903-3570-051	99903-3680-051	99903-3500-051
250 Abrazaderas Sólo	99902-1674-051	99902-1671-051	99902-1570-051	99902-1680-051	99902-1500-051
450 Abrazaderas Sólo	99902-2674-051	99902-2671-051	99902-2570-051	99902-2680-051	99902-2500-051
600 Abrazaderas Sólo	99902-3674-051	99902-3671-051	99902-3570-051	99902-3680-051	99902-3500-051

*Disponible con código de barras (individualmente), reemplazar 051 con 053

Kit de Centro de Ganancias SmartSeal®

Incluye

- Estante para Abrazaderas SmartSeal: Contiene hasta 50 abrazaderas y contiene un plafon perforado y ganchos
- Abrazaderas SmartSeal: 50 Abrazaderas en sub-empaques de 10 piezas en tamaños de 20, 24, 28, 36, y 40
- Abrazaderas en empaque surtido de burbuja/Blister SmartSeal, dos de cada tamaño: 20, 24, 28, 36, y 40



17-3/8" H x 16" W x 6-13/16" D
Número de Pieza: **2688001**

LOCALICE NÚMERO DE PARTE

Solo para Rack de Abrazadera SmartSeal	2688001
Solo Abrazaderas SmartSeal: 50 Piezas	99902-7215-051*
Estante para Abrazaderas SmartSeal + Abrazaderas	99903-7215-051*
Centro de Ganancias Smart Seal: Estante + Surtido de Abrazaderas con Porta Tiras	99904-7215-051*
Surtido de Abrazaderas con Porta Tiras	99904-7215-058

*Abrazaderas disponibles con codigo de barras individuales. Reemplace el numero de parte 051 con el 053



Cajas para Empacar



Empaques de Blíster

Bolsas con 25 Piezas para Contratistas



- Todo de Acero Inoxidable
- Certificada por el Codigo UPC (Uniform Plumber Code)
- Bolsas resellables durables

LOCALICE NÚMERO DE PARTE

Tamaño	Mínimo (pul)	Máximo (pul)	Mínimo (mm)	Máximo (mm)	Descripción	Cantidad	Número de Pieza
4	5/16	5/8	8	16	Micro-Gear®	25	6260450
6	5/16	7/8	8	22	Micro-Gear®	25	6260650
6	3/8	7/8	10	22	1/2" Hy-Gear®	25	6706550
8	7/16	1	11	25	1/2" Hy-Gear®	25	6708550
10	1/2	1-1/16	13	27	1/2" Hy-Gear®	25	6710550
12	1/2	1-1/4	13	32	1/2" Hy-Gear®	25	6712550
16	11/16	1-1/2	18	38	1/2" Hy-Gear®	25	6716550
20	3/4	1-3/4	19	44	1/2" Hy-Gear®	25	6720550
24	1	2	25	51	1/2" Hy-Gear®	25	6724550
28	1-1/4	2-1/4	32	57	1/2" Hy-Gear®	25	6728550
36	3/4	2-3/4	19	70	1/2" Hy-Gear®	25	6736550
48	1-1/2	3-1/2	38	89	1/2" Hy-Gear®	25	6748550
64	2-1/2	4-1/2	64	114	1/2" Hy-Gear®	25	6764550

Bolsas de 10 piezas surtidas



Número de Pieza: **671755J**

Carton maestro con cantidad de 10

- Bolsas resellables con 10 Piezas
- Surtido de Abrazaderas de Acero Inoxidable
- Rango de ajuste de 1/4 hasta 2-3/4"
- Certificada por el Código UPC (Uniform Plumber Code)

CANTIDADES POR BOLSA

Tamaño	Cantidad
Micro-Gear® 4	2
1/2" Hy-Gear® 6	1
1/2" Hy-Gear® 12	3
1/2" Hy-Gear® 20	3
1/2" Hy-Gear® 36	1

Línea de Producto de Empaque de Burbuja/Blister

AGREGANDO VALOR A SU NEGOCIO

IDEAL-TRIDON® le ofrece una extensiva línea de productos con empaque de burbuja/blíster. Los paquetes blíster le ofrecen fácil visibilidad, empaque atractivo y en cantidades convenientes. Variedad de anchos de banda, especificación de los materiales, opciones de tamaños y se dispone también en paquetes surtidos. Los populares productos en empaque burbuja/blíster le agrega valor al producto, al ofrecerle a los clientes una fácil y rápida manera de localizar la abrazadera que necesiten y comprar lo que ellos requieren en pequeñas cantidades.



EXHIBIDORES & EMPAQUETADOS

LOCALICE NÚMERO DE PARTE

Descripción	Cantidad por Embalaje	Tamaño SAE	Mínimo (pul)	Máximo (pul)	Mínimo (mm)	Máximo (mm)	Material de la Banda	Material de la Carcasa	Material del Tornillo	Ancho de la Banda	Número de Pieza
SmartSeal® 37215	2	20	1-1/8	1-9/16	29	40	300 SS	300 SS	300 SS	1/2	37215-0020-058
SmartSeal® 37215	2	24	1-1/2	1-13/16	38	46	300 SS	300 SS	300 SS	1/2	37215-0024-058
SmartSeal® 37215	2	28	1-3/4	2-1/16	43	52	300 SS	300 SS	300 SS	1/2	37215-0028-058
SmartSeal® 37215	2	36	2-1/8	2-9/16	53	65	300 SS	300 SS	300 SS	1/2	37215-0036-058
SmartSeal® 37215	2	40	2-5/16	2-13/16	58	71	300 SS	300 SS	300 SS	1/2	37215-0040-058
Paquete Sortido de Juego de Abrazaderas de Emergencia 62M y 50	6	4, 12, 28 (2 each)	1/4	2-1/4	6	57	200 SS	200 SS	PCS	5/16, 9/16	5004058
Hy-Gear® 50	2	12	1/2	1-1/4	13	32	200 SS	200 SS	PCS	9/16	5012058
Hy-Gear® 50	2	20	3/4	1-3/4	19	44	200 SS	200 SS	PCS	9/16	5020058
Hy-Gear® 50	2	28	1-1/4	2-1/4	32	57	200 SS	200 SS	PCS	9/16	5028058
Hy-Gear® 50	2	36	3/4	2-3/4	19	70	200 SS	200 SS	PCS	9/16	5036058
Hy-Gear® 50	2	48	1-1/2	3-1/2	38	89	200 SS	200 SS	PCS	9/16	5048058
Micro-Gear® 52M	4	4	5/16	5/8	6	16	200 SS	PCS	PCS	5/16	5202058
Micro-Gear® 52M	4	6	5/16	7/8	8	22	200 SS	PCS	PCS	5/16	5203058
52 Paquete Sortido	6	4, 12, 28 (2 each)	5/16	2-1/4	6	57	200 SS	PCS	PCS	5/16, 1/2	5204058
52	2	12	1/2	1-1/4	13	32	200 SS	PCS	PCS	1/2	5212058
52	2	20	3/4	1-3/4	19	44	200 SS	PCS	PCS	1/2	5220058
52	2	28	1-1/4	2-1/4	32	57	200 SS	PCS	PCS	1/2	5228058
52	2	36	1-3/4	2-3/4	44	70	200 SS	PCS	PCS	1/2	5236058
52	2	48	2-1/2	3-1/2	64	89	200 SS	PCS	SS	1/2	5248058
52	2	64	2-1/2	4-1/2	64	114	200 SS	PCS	PCS	1/2	5264058
Hy-Gear® 57	2	12	1/2	1-1/4	13	32	200 SS	200 SS	PCS	1/2	5512058
Hy-Gear® 57	2	20	3/4	1-3/4	19	44	200 SS	200 SS	PCS	1/2	5520058
Hy-Gear® 57	2	28	1-1/4	2-1/4	32	57	200 SS	200 SS	PCS	1/2	5528058
Hy-Gear® 57	2	36	3/4	2-3/4	19	70	200 SS	200 SS	PCS	1/2	5536058
Micro-Gear® 62P	4	4	5/16	5/8	8	16	300 SS	300 SS	PCS	5/16	6204058
Micro-Gear® 62P	4	6	5/16	7/8	8	22	300 SS	300 SS	PCS	5/16	6206058
Fuel-Injection 52F	4	13	7/16	1/2	11	13	PCS	-	PCS	9 mm	52F1358
Fuel-Injection 52F	4	15	1/2	9/16	13	15	PCS	-	PCS	9 mm	52F1558
Fuel-Injection 52F	4	16	9/16	5/8	14	16	PCS	-	PCS	9 mm	52F1658
Turn-Key® 5Y Paquete Sortido	6	4, 6, 12, 20, 28, 36 (1 each)	5/16	2-3/4	8	70	200 SS	300 SS	PCS	5/16, 1/2	5Y00158
Turn-Key® 5Y	2	12	1/2	1-1/4	13	32	200 SS	300 SS	PCS	1/2	5Y01258
Turn-Key® 5	2	20	3/4	1-3/4	19	44	200 SS	300 SS	PCS	1/2	5Y02058
Turn-Key® 5Y	2	28	1-1/4	2-1/4	32	57	200 SS	300 SS	PCS	1/2	5Y02858
Turn-Key® 5Y	2	36	1-3/4	2-3/4	44	70	200 SS	300 SS	PCS	1/2	5Y03658
Turn-Key® 5Y Surtido de Abrazaderas	2	48	2-1/2	3-1/2	64	89	200 SS	300 SS	PCS	1/2	5Y04858
Turn-Key® 5Y	2	64	2-1/2	4-1/2	64	114	200 SS	300 SS	PCS	1/2	5Y06458
Turn-Key® 6Y Paquete Sortido	4	4, 6 (2 each)	5/16	7/8	8	22	200 SS	300 SS	PCS	5/16	6Y00458

SS = Acero Inoxidable
PCS = Acero Carbono Recubierto

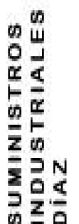

GUÍA DE REFERENCIA DE PRODUCTOS

Producto	Ideal-Tridon	Tridon	Descripción del Producto	NORMA Breeze RG Ray	Murray	Dixon	Página en Catálogo
Turn-Key®	5Y	-	Banda de 1/2", Producto de Consumo - No Requiere Herramientas	-	T-SS	HS-Y	25
Pow'r-Gear®	6L	M843	Banda de 5/8", Abrazadoras de Tornillos Sinfin, Alto Rendimiento Revestidas Todas en Acero Inoxidable	HTM-L SP	-	-	28
Pow'r-Gear®	6M	-	Banda de 5/8", Abrazadoras Marinas de Tornillo Sinfin Alto Rendimiento Todo Grado 300	HTS-L	-	-	28
Pow'r-Gear®	6P	-	Banda de 5/8", Abrazadoras Marinas de Tornillo Sinfin Alto Rendimiento Todo Grado 300	HTM SP	-	-	28
Pow'r-Gear®	6X	-	Banda de 5/8", Abrazadoras de Tornillo Sinfin Alto Rendimiento Rango Ancho Todo Acero Inoxidable	HP	-	HP	28
Pow'r-Gear®	60	M850	Banda de 5/8", Abrazadoras de Tornillo Sinfin Alto Rendimiento Todo Acero Inoxidable	HTM	-	HTM	28
Flex-Gear® HD	41	-	Banda de 5/8", Abrazadoras de Tensión Constante	CT-L	-	CT-L	36
Flex-Gear®	43	-	Banda de 9/16", Abrazadoras de Tensión Constante	CT-92	-	-	36
Flex-Gear® HD	45	-	Banda de 5/8", Abrazadoras de Tensión Constante	CT-LSS	-	-	36
Flex-Gear®	47	-	Banda de 9/16", Abrazadoras de Tensión Constante	CT-94	-	-	36
Surelock	48	-	Banda de 9/16", Abrazadoras de Enganche Rápido, Acero Inoxidable Grado 300 Marina	600	-	-	21
Surelock	49	-	Banda de 9/16", Abrazadoras de Enganche Rápido, Acero Inoxidable Grado 300 Marina	616	-	-	21
9/16" Hy-Gear®	50-0	150	Banda de 9/16", Abrazaderas Parcialmente de Acero Inoxidable	100	-	HS**	14
1/2" Hy-Gear®	52-0	600-603	Banda de 1/2", Abrazaderas con contenido Parcial de Acero Inoxidable	-	-	-	12
Revestidas	53-0	613/ET	Banda de 1/2", Abrazaderas Revestidas con Contenido Parcial de Acero Inoxidable	92	48	DL	26
Combo-Hex®	54-0	-	Banda de 9/16", Abrazadera de Tornillo Hexagonal Especial	-	-	-	20
Snaplock®	56-0	-	Banda de 9/16", Abrazaderas de Liberación Rápida Quick	-	-	LS	22
1/2" Hy-Gear®	57-0	611/HS	Banda de 1/2", Abrazaderas de Uso General	62	H	HS**	12
Snaplock®	58-0	58-0/LAS	Banda de 9/16", Abrazaderas de Liberación Rápida	-	-	LSS	21
Crimpeo	61-0	-	Abrazadera de Crimpeo Sencillo todas de Acero Inoxidable Tipo 300	-	-	KS	19
Wraplock®	59-0	-	Banda de 1/2", Abrazaderas Especiales	-	-	-	24
9/16" Hy-Gear®	64-0	-	Banda de 9/16", Abrazaderas de Tornillo Hexagonal Especial	200	-	-	14
9/16" Hy-Gear®	68-0	-	Banda de 9/16", Abrazaderas de Uso General Todo Acero Inoxidable	200	-	-	14
Lox-On®	69-0	-	Banda de 1/2", Abrazaderas de Uso Especial Marina Todo Grado 300	-	-	-	24
Snaplock®	500	500/LS	Banda de 1/2", Abrazaderas de Liberación Rápida	-	-	LS	22
Snaplock®	550	550/LSS	Banda de 1/2", Abrazaderas de Liberación Rápida	-	-	LSS	22
Fuel Injection	52F	905/FI	Banda de 9 mm, Abrazaderas Especiales de Inyección de Combustible	FI	-	-	11
Micro-Gear®	52M	300	Banda de 5/16", Abrazaderas con Contenido Parcial de Acero Inoxidable	-	-	-	10
Micro-Gear®	359	359	Banda de 5/16", Abrazaderas de Uso General Todo Acero Inoxidable	38	-	-	10
Micro-Gear®	62M	345/MAH/MAS	Banda de 5/16", Abrazaderas Todas de Acero Inoxidable	37/67	MMF-SS	MAH	10
Micro-Gear®	62P	325/MH	Banda de 5/16", Abrazaderas con Contenido Parcial de Acero Inoxidable	35	MM	MH	10
Militar	632	632	Bandas de 1/2", Abrazaderas de Especificación Militar	MS	-	-	20
Turn-Key®	6Y	-	Producto para el Consumidor Abrazaderas con Contenido Parcial de Acero Inoxidable - No Requiere Herramientas	-	-	MH	25
9/16" Hy-Gear®	63-4	-	Banda de 9/16", Abrazaderas Marinas Todo Grado 300 Acero Inoxidable	300	-	HSS**	14
Revestidas	65-E	615*	Banda de 9/16", Abrazaderas Forradas, Todo Grado 300 Acero Inoxidable	94*	48	-	26
1/2" Hy-Gear®	67-1	625/HAS	Banda de 1/2", Abrazaderas de Uso General Todo Acero Inoxidable	64	H-SS	-	12
1/2" Hy-Gear®	67-4	620P	Banda de 1/2", Abrazaderas Marinas Todo Grado 300 Acero Inoxidable	63	HF-SS	HSS**	12
1/2" Hy-Gear®	67-5	620	Banda de 1/2", Abrazaderas Todo Grado 200 Acero Inoxidable	-	-	-	12
1/2" Hy-Gear®	67-6	665	Banda de 1/2", Abrazaderas Marinas Todo Grado 316 Acero Inoxidable	-	HDL	MGC	12
Revestidas	67M	-	Banda de 1/2", Abrazaderas Marinas Forradas Todo Grado 316 Acero Inoxidable	96	-	-	26
Pernos Tipo T	30010	813	Banda de 3/4", Abrazaderas de Perno en T con Contenido Parcial de Acero Inoxidable	B9200	TB	-	30
Pernos Tipo T	30011	811	Banda de 3/4", Abrazaderas de Perno en T con Contenido Todo de Acero Inoxidable	B9300	TB-SS	-	30
Pernos Tipo T	30020	814	Banda de 3/4", Abrazaderas de Perno en T con Contenido Parcial de Acero Inoxidable	B9222	-	-	30
Pernos Tipo T	30021	810	Banda de 3/4", Abrazaderas de Perno en T con Contenido Todo de Acero Inoxidable	-	-	-	30
Pernos Tipo T	30030	819	Banda de 3/4", Abrazadera de Perno en T con Resorte	B9226	TBL	-	33
Pernos Tipo T	30050	-	Banda de 3/4", Abrazaderas de Perno en T Tamaño Nominal con Contenido Parcial de Acero Inoxidable	-	-	TBC	32
Pernos Tipo T	30051	-	Banda de 3/4", Abrazaderas de Perno en T Tamaño Nominal con Contenido Todo de Acero Inoxidable	-	-	STBC	32
WaveSeal ^{®60}	36003	36013	Banda de 9/16", Presión Constante Auto Ajustable	-	-	WSS	8
SmartSeal®	37215	-	Banda de 1/2", Presión Constante Auto Ajustable	-	DB	-	8
SmartSeal® HD	38215	38210	Banda de 5/8", Presión Constante Auto Ajustable	**	-	-	8
Sin Perforaciones	53302	53312	Banda de 9 mm, Abrazaderas Sin Perforaciones W2	TORRO W2**	EB9	-	16
Sin Perforaciones	53303	53313	Banda de 9 mm, Abrazaderas Sin Perforaciones W3	TORRO W3**	-	-	16
Sin Perforaciones	53304	53314	Banda de 9 mm, Abrazaderas Sin Perforaciones W4	TORRO W4**	-	EB9	16
Sin Perforaciones	53305	53315	Banda de 9 mm, Abrazaderas Sin Perforaciones W5	TORRO W5**	-	EBL9	16
Sin Perforaciones	53402	53412	Banda de 12 mm, Abrazaderas Sin Perforaciones W2	TORRO W2**	EB12	-	16
Sin Perforaciones	53403	53413	Banda de 12 mm, Abrazaderas Sin Perforaciones W3	TORRO W3**	-	-	16
Sin Perforaciones	53404	53414	Banda de 12 mm, Abrazaderas Sin Perforaciones W4	TORRO W4**	-	EB12	16
Sin Perforaciones	53405	53415	Banda de 12 mm, Abrazaderas Sin Perforaciones W5	TORRO W5**	-	EBL12	16

* Producto Comparable

** Consultar el Ancho de la Banda



SUMINISTROS INDUSTRIALES DIAZ



7821606595
7821604051
7821610766



contacto@sidadz.com



www.sidadz.com





**SUMINISTROS
INDUSTRIALES
DÍAZ**



**Av. Puebla 515
Col. Palma Sola, CP 93320
Poza Rica Veracruz, México**

Teléfonos

**7821606595
7821604051
7821610766**



www.sidiaz.com



Suministros Industriales Díaz



contacto@sidiaz.com



@SiDiazMex



@sidiazmex



Suministros Industriales Díaz