



**SUMINISTROS
INDUSTRIALES
DÍAZ**

CATÁLOGO MIKEL'S

CORPORATIVO 2019



VISÍTENOS EN:

Av. Puebla 515 Col. Palma Sola, CP 93320.

Poza Rica Veracruz, México

Teléfonos: 7821606595, 7821604051 y 7821610766



contacto@sidadz.com



www.sidadz.com





Índice Alfabético / ALPHABETICAL INDEX

A	
Aceite hidráulico para gato 1 L	36
Aceiteras de presión bote de acero, tubo rígido	59
Acopladores para arrastre	66
Adaptador para transmisiones para gatos de patin 500 kg	44
Aerógrafos	102
Alforjas semi rígidas	79
Alineadora 3D	31
Arrancadores de baterías	82
Aspiradoras para auto 12 volts	95
Aspiradoras solidos y líquidos	82
B	
Balaceadora de llantas	30
Bancos para mecánico	17
Banda para malacate tensor	20
Barras porta equipaje	18
Bastones de seguridad	11
Bolas de arrastre	66
Bolsa protectoras de equipaje	18
Bolsillo organizador para tablero	11
Bomba hidroneumática acción simple	28
Bombas de aire	71-98
Bombas de aire	93
Bombas extractoras / rotativas	61
Boquilla para inyector	62
Boquillas para balón	98
Boya para limpieza de inyectores	45
Bungees cinturones elásticos	80
C	
Cabezales para compresores de aire	84
Cables candado y candados de Seguridad	74 / 98-99
Cables pasa corriente	20
Cables pasa corriente para moto	77
Caja para herramientas 6 cajones	26
Cajas plásticas para Herramientas	98
Calafateadora	100
Calibradores de presión	16
Camas para mecánico	17
Canastilla porta equipaje	18
Candado rígido de acero tipo U	74
Candados para frenos de disco	80
Caretas para soldar electrónicas	94
Cargadores de baterías	83
Cargo box rígida	18
Carpas para Jardín	100
Carrete con extensión eléctrica	90
Carretes con manguera para aceite / grasa	59
Carretes para aire a presión	19
Carrito de servicio con triple charola	26
Chalecos de seguridad reflejante	101
Charola magnética rectangular	26
Charola plegable plástica	11
Cinchos de plástico	100

Cintas ajustables	11
Cinturón de seguridad para mascota	13
Cinturones para sujetar carga	20
Cizalla neumática	52
Compactador neumático para filtros de aceite	26
Compresor para aerógrafo	102
Compresores de aire	84-86
Compresores de aire a gasolina	86
Compresores de aire para auto 12 Volts	95-96
Conexión de presión rápida 1/4" NPT	15
Conos de seguridad	25
Cople porto power	28
Cortadora de disco neumática	52
Cortadora de plasma	93
Cubetas de lubricación	60
Cubierta de asientos para mascota	13
Cubiertas para auto	13
Cubiertas para motocicleta	79
Cubrevolantes universales	12
D	
Dados adaptadores	106
Dados cortos	105
Dados de Impacto calidad industrial	21
Dados largos	105-106
Desarmadores	107-108
Desarmador de impacto	49
Desengrasante	26
Desmontadoras de llantas	32
Despegador de ceja (bazooca)	57
Diablos plegables	101
Dispensador neumático de aceite	61
Dobladoras para tubo	122
Dolly para auto	26
Dollys para motocicleta	77
E	
Elevadores electrohidráulicos	24
Embudos plásticos	100
Enderizador de chasis	28
Engrapadora tipo pistola	101
Engrasadora de baleros profesional	28
Equipo de recuperación y reciclaje de aire acondicionado	50
Escalón de trabajo	11
Eslinga remolcadora	20
Eslingas	103
Esmeriladora neumática	51
Esmeriles de banco	82
Espátulas	57
Espejos retrovisores universales para moto	78
Estante para herramientas 6 cajones	27
Estantes para almacenaje	101
Estuche para celular (moto)	77
Estuche y soporte para celular (bici)	72
Extensiones	106
Extintores de emergencia	29

Extractor de capuchón	21
Extractores de aceite	61
F	
Filtros reguladores y lubricadores	51
G	
Gabinetes modulares	27
Ganchos tensores para motocicleta	80
Gato de cremallera	38
Gato para motocicleta y cuatrimotos	76
Gato para remolque	66
Gato sacarruedas "YO-YO"	31
Gatos de tijera	38
Gatos de uña	122
Gatos hidráulicos de botella	34-36
Gatos hidráulicos de patin	30-42
Gatos hidráulicos de patin trabajo pesado	43
Gatos hidráulicos especiales	37
Gatos hidráulicos para pluma	45
Gatos hidráulicos telescópicos de botella	38
Gatos hidroneumáticos	39
Gatos mecánicos de escalera	123
Gatos para transmisiones	44
Generadores de corriente eléctrica	89
Generadores de nitrógeno	33
Grúa para camioneta	63
Guante de nitrilo TITAN	120
Guantes de seguridad TITAN	118-120
Guante para motociclismo	79
Guantes para trabajo	104
H	
Hidrolavadoras de alta presión eléctricas / gasolina	87-88
I	
Impermeable tipo manga	101
Indicadores de presión para llantas	16
Inflador automático de llantas	50
Inflallantas	13
Inflallantas con manómetro	16
Intercambiador de aceite de transmisión automática	50
Inversores de corriente	96
Inyectores de grasa	62
J	
Juego de accesorios neumáticos	15
Juego de barras desmontadoras	29
Juego de herramienta automotriz	47
Juego de puntas torx para ajuste de motor	47
Juegos de dados	111
K	
Kits de herramienta especializada	46-50
Kit de herramienta multipropósito	111
Kits y multiherramientas para ciclista	71-72
Kits de emergencia automotriz	54-56
Kit de arrastre	66
Kit de herramienta automotriz	111
Kits de reparación para llantas de moto	77





Índice Alfabético / ALPHABETICAL INDEX

L	
Laboratorio de inyectoras	50
Lámparas de halógeno	92
Lámparas de LED	91
Lámparas solares	92
Lengüetas de arrastre	66
Lentes de protección	100
Linternas para ciclismo	72
Lijadora orbital neumática	51
Limpiaparabrisas	14
Llaves ajustables PERICO	110
Llaves combinadas estandar/milimétricas	110
Llaves de artillería	57
Llaves de cruz / plegables	58
Llaves para filtro de aceite	45
Luminarios de emergencia	90
M	
Malacate tensor soldable	20
Malacates	117
Maleta para tanque de gasolina	79
Maletas para herramientas	113
Manerales para llave de artillería industrial	58
Manga kevlar TITAN	119
Mangueras flexibles con resortes de acero	62
Mangueras para aire a presión	19
Manifolds	133
Matracas cabeza de pera	106
Matracas de impacto neumáticas	51
Mesa de trabajo con ruedas	27
Mesas elevadoras	123
Mochila multiusos para motociclismo	79
Montacargas hidráulicos / eléctricos	124-125
Motobombas para agua a gasolina	88
Mototool	51
Multiherramientas	113-116
Multímetros	93
Multiplicadores de torque	29
N	
Navajas	116
Nivelador de carga	45
O	
Opresores de resortes	66
Organizadores para cajuela	11
Overoles desechables TITAN	120
P	
Palanca para malacate tensor	20
Paneles de almacenamiento	111
Paquetes para motociclismo	79
Parasoles	13
Patines hidráulicos / traspaletas	125-127

Pedestal elevador para motocicleta	76
Pinzas	109-110
Pistola de impacto eléctrica / inalámbrica	90
Pistola para inflado de llantas con manómetro	16
Pistola para sopleteado	16
Pistolas de aire para pintado	102
Pistolas de calor	90
Pistolas de impacto neumáticas	52-53
Pistolas eléctricas para pintado	102
Pistones hidráulicos	123
Plataformas hidráulicas para motocicleta	76
Plumas Hidráulicas para Motor	63
Polipastos manuales / eléctricos	128-130
Porto power	28
Prensas hidráulicas	64-65
Prensas hidroneumáticas	65
Probador de baterías	83
Probador de chispa automotriz	50
Probadores de corriente	93
Pulidora neumática	51
Pulidoras automotrices	92
Puños para motocicleta negro	78
R	
Racks para Bicicletas	73
Rampa elevadora portátil	21
Rampa elevadora de alineación	31
Rampas elevadoras para estacionamiento	22-23
Rampas troqueladas	27
Recibidores de aceite	61
Redes de carga para motocicleta	80
Redes sujetadoras de carga	11
Repuestos reparación llantas de moto	77
S	
Seguros para rines	15
Set de llaves combinadas con matraca	49
Sierra cortadora neumática	51
Soldadoras	93-94
Sombrilla para auto	13
Soportes para bicicletas	73
Soporte universal para motocicleta	76
Soportes para Motor	67
T	
Tanque asentador de ceja Cheeta®	33
Tanque industrial para pintar	102
Tanques metálicos para gasolina	25
Tanques para aire comprimido	33
Tapetes para auto	12
Termómetro infrarojo	50
Tijeras multiusos	113

Tina limpia partes de motor	26
Tinas de limpieza por ultrasonido	26
Topes para estacionamiento	26
Tornillos de banco	112
Torno para frenos	33
Torquímetro	50
Torres para automóvil / trailer	67
Triángulos reflejantes	25
Troles y Abrazaderas para viga	131
V	
Válvula para inflado de llantas	15
W	
Winch eléctrico	38
Exhibidores	139-140
Artículos promocionales	141
OEM	135
Mr Brillo	137-138
WOW	130

Aplicación del Índice

1.- Dirigirse al nombre del producto que se busca en orden alfabético (Ej. Fig. 1)

Kit para de llantas convencionales y abs	45
Kit y multiherramientas para ciclista	89-90
Kit de emergencia automotriz	53-55
Kit de reparación para llantas de moto	74

(Ej. Fig. 1)

2.- El color del número de página indicará la línea a la que pertenece (Ej. Fig. 2)

M	Pág.
Malacate tensor soldable	20
Malacates	117
Maleta para tanque de gasolina sujeción magnética	72

(Ej. Fig. 2)

Para que localice con mayor facilidad la página, sitúese en la placa correspondiente al color (lado derecho del índice) y siga la altura de la placa hasta encontrarla.

para frenos	33
para automóvil jack stands	66
para reflejante	25
y abrazaderas para viga	131

Características técnicas

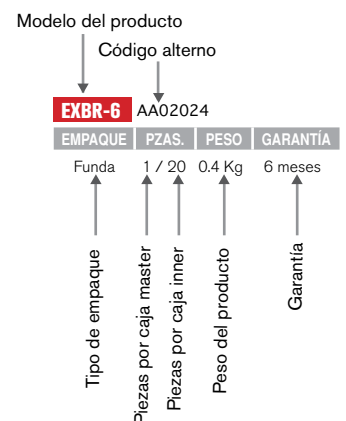



SUMINISTROS
INDUSTRIALES
DÍAZ

MIKEL'S



Línea **Automotriz**

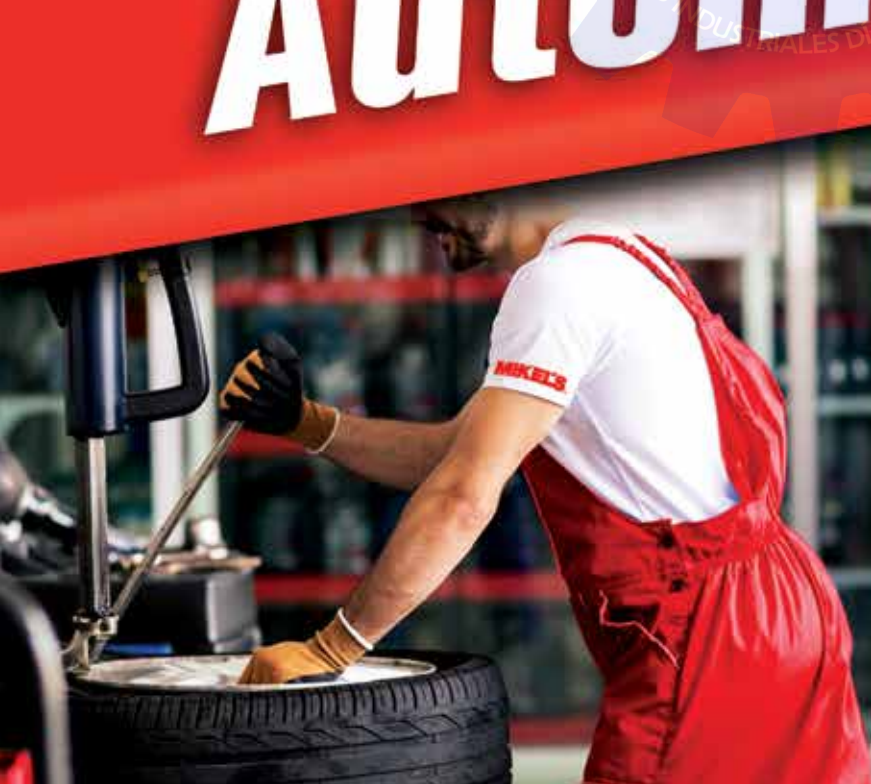

7821606595
7821604051
7821610766



contacto@sidadz.com



www.sidadz.com





Accesorios Automotrices / AUTOMOTIVE ACCESSORIES

Bastones de seguridad

STEERING WHEEL SECURITY LOCK

Uso ligero

Light duty



BAV-50 AA02003

EMPAQUE	PZAS.	PESO	GARANTÍA
Blister	16	1 Kg	6 meses

Uso rudo

Heavy duty



Cabe dentro de la guantera
Diseño compacto
Telescópico

BHD-37 AA02004

EMPAQUE	PZAS.	PESO	GARANTÍA
Blister	12	2 Kg	6 meses

Escalón de trabajo

Work Step

256 kg

Ideal para cualquier tipo de Lanta.



ET-500 AA08018

EMPAQUE	PZAS.	PESO	GARANTÍA
Caja Color	1	5.5 Kg	1 año

Organizadores para Cajuela

TRUNK ORGANIZERS

Sencillo

Single

100% poliamida



OC-51 AA02051

EMPAQUE	PZAS.	PESO	GARANTÍA
Funda	12	0.8 Kg	6 meses

51 cm X 26 cm X 26 cm

* No incluye herramientas
Tools not included

Múltiple

Multiple

100% poliamida



OC-80 AA02052

EMPAQUE	PZAS.	PESO	GARANTÍA
Funda	10	1.2 Kg	6 meses

80 cm X 30 cm X 30 cm

* No incluye herramientas
Tools not included

Charola plegable plástica

Foldable plastic tray

40 cm x 20 cm

Sistema de sujeción con ganchos



CH-PP1 AA02100

EMPAQUE	PZAS.	PESO	GARANTÍA
Blister	6/24	0.2 Kg	6 meses

Cinta ajustable

40" to 60" adjustable bungee band

de 40 cm a 60 cm



CB-4060 AA13012

EMPAQUE	PZAS.	PESO	GARANTÍA
Colgador	1/48	0.6 Kg	6 meses

Cinta ajustable juego de 3 pzs

3 pzs. set bungee bands

de 40 cm a 60 cm



JCB-3 AA13011

EMPAQUE	PZAS.	PESO	GARANTÍA
Colgador	1/48	0.6 Kg	6 meses

Bolsillo organizador para tablero

Organizer pouch

15 cm x 25 cm

Sujeción con cinta autoadherible



BOT-1 AA02101

EMPAQUE	PZAS.	PESO	GARANTÍA
Funda	6/24	0.09 Kg	6 meses

Red sujetadora de carga

Organizer net

60 cm x 120 cm



RS-2460 AA02102

EMPAQUE	PZAS.	PESO	GARANTÍA
Blister	6	0.4 Kg	6 meses

Red de carga tipo hamaca

Hammock type organizer net

30 cm x 120 cm

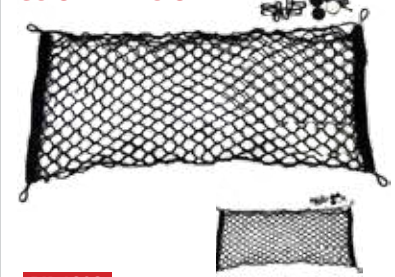

RH-1260 AA02103

EMPAQUE	PZAS.	PESO	GARANTÍA
Blister	6	0.4 Kg	6 meses





Accesorios Automotrices / AUTOMOTIVE ACCESSORIES

Tapetes para Autos

AUTOMOTIVE FLOORMATS

Transparente

Clear
PVC



Frontales: 43 cm X 64 cm
Traseros: 44.5 cm X 34 cm

TC AA02075

EMPAQUE	PZAS.	PESO	GARANTÍA
Caballote	10	1 Kg	2 años

Negro

Black
PVC



Frontales: 43 cm X 64 cm
Traseros: 44.5 cm X 34 cm

TC-1 AA02076

EMPAQUE	PZAS.	PESO	GARANTÍA
Caballote	10	1.5 Kg	2 años

Negro

Black
PVC



Frontales: 43 cm X 64 cm
Traseros: 44.5 cm X 34 cm

TC-2 AA02077

EMPAQUE	PZAS.	PESO	GARANTÍA
Caballote	10	1.86 Kg	2 años

Negro de lujo

Black deluxe
HULE NBR



Frontales: 45 cm X 68 cm
Traseros: 44.5 cm X 34 cm

TA-1 AA02072

EMPAQUE	PZAS.	PESO	GARANTÍA
Caballote	6	3.6 Kg	2 años

Gris de lujo

Gray deluxe
HULE NBR



Frontales: 45 cm X 68 cm
Traseros: 44.5 cm X 34 cm

TA-2 AA02073

EMPAQUE	PZAS.	PESO	GARANTÍA
Caballote	6	3.6 Kg	2 años

Camello de lujo

Camel deluxe
HULE NBR



Frontales: 45 cm X 68 cm
Traseros: 44.5 cm X 34 cm

TA-3 AA02074

EMPAQUE	PZAS.	PESO	GARANTÍA
Caballote	6	3.6 Kg	2 años

Negro Premium

Black deluxe



Frontales: 45 cm X 68 cm
Traseros: 44.5 cm X 34 cm

TA-4 AA02128

EMPAQUE	PZAS.	PESO	GARANTÍA
Caballote	6	4 Kg	2 años

Negro Premium

Black deluxe
HULE NBR



Frontales: 45 cm X 68 cm
Traseros: 44.5 cm X 34 cm

TA-5 AA02129

EMPAQUE	PZAS.	PESO	GARANTÍA
Caballote	6	4.7 Kg	2 años

Cubre volantes Universales

STEERING WHEEL COVERS

Tipo piel color camello

Beige



CU-PC AA02026

EMPAQUE	PZAS.	PESO	GARANTÍA
Caballote	20	0.6 Kg	6 meses

Tipo piel deportivo

Sport



CU-PD AA02027

EMPAQUE	PZAS.	PESO	GARANTÍA
Caballote	20	0.6 Kg	6 meses

Tipo piel color gris

Gray



CU-PG AA02028

EMPAQUE	PZAS.	PESO	GARANTÍA
Caballote	20	0.6 Kg	6 meses

Tipo piel color negro

Black



CU-PN AA02029

EMPAQUE	PZAS.	PESO	GARANTÍA
Caballote	20	0.6 Kg	6 meses

Tipo armadillo

Armadillo style



CU-1 AA02022

EMPAQUE	PZAS.	PESO	GARANTÍA
Caballote	25	0.4 Kg	6 meses

Tipo madera texturizada

Texturized wood style



CU-2 AA02023

EMPAQUE	PZAS.	PESO	GARANTÍA
Caballote	25	0.4 Kg	6 meses

Tipo madera

Wood style



CU-3 AA02024

EMPAQUE	PZAS.	PESO	GARANTÍA
Caballote	25	0.4 Kg	6 meses

Negro texturizado

Black texturized



CU-4 AA02025

EMPAQUE	PZAS.	PESO	GARANTÍA
Caballote	25	0.4 Kg	6 meses





Accesorios Automotrices / AUTOMOTIVE ACCESSORIES

Cubierta de asientos para mascota

Pet seat cover



CAPM AA02111

EMPAQUE	PZAS.	PESO	GARANTÍA
Caballote	30	1.6 Kg	3 meses

Cinturón de seguridad para mascota

Pet safety belt



CISMA AA2109

EMPAQUE	PZAS.	PESO	GARANTÍA
Blisters	48	0.5 Kg	3 meses

Parasoles / Windshield cover

135 cm x 58 cm



PFLEX-1 AA02104

EMPAQUE	PZAS.	PESO	GARANTÍA
Blisters	6	0.09 Kg	3 meses

125 cm x 60 cm

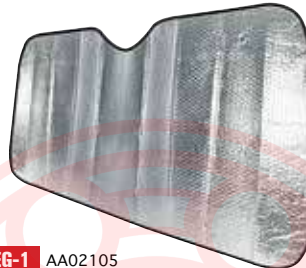

PPLEG-1 AA02105

EMPAQUE	PZAS.	PESO	GARANTÍA
Blisters	6	0.09 Kg	3 meses

SET 3 piezas ventanillas y parabrisas
125 cm x 60 cm



SPS-3 AA02017

EMPAQUE	PZAS.	PESO	GARANTÍA
Blisters	6	0.1 Kg	3 meses

Cubiertas para Auto / CAR COVERS

- 100% Polipropileno
- Protegen la pintura e interior del vehículo
- Respirable, no atrapan la humedad
- Bordes elásticos ajustables

Chica/Small



MEJORADO

CA-CH AA02013 **462 cm X 121 cm X 137 cm**

EMPAQUE	PZAS.	PESO	GARANTÍA
Caja Color	1	1.7 Kg	3 meses

Mediana/Medium



MEJORADO

CA-M AA02015 **502 cm X 152 cm X 136 cm**

EMPAQUE	PZAS.	PESO	GARANTÍA
Caja Color	1	2.2 Kg	3 meses

Grande/Large



MEJORADO

CA-G AA02014 **584 cm X 152 cm X 129 cm**

EMPAQUE	PZAS.	PESO	GARANTÍA
Caja Color	1	2.5 Kg	3 meses

Sombrilla Automática para Auto

Automatic Car Umbrella



2.1 m

NEW!



3.5 m

SAA-35 AA02130

EMPAQUE	PZAS.	PESO	GARANTÍA
Caja Color	1	6.6 Kg	3 meses

Inflallantas / MAGIC TIRE

340 gr
12 oz

Ideal para Autos



MT-12 AA21009

EMPAQUE	PZAS.	PESO	GARANTÍA
Caja	12	0.4 Kg	3 meses

567 gr
20 oz

Ideal para Autos y Camionetas



MT-20 AA21010

EMPAQUE	PZAS.	PESO	GARANTÍA
Caja	6	0.8 Kg	3 meses





Accesorios Automotrices / AUTOMOTIVE ACCESSORIES

Limpiaparabrisas frameless

FRAMELESS WINDSHIELD WIPERS



16"
PFL-16 AA02090
EMPAQUE | PZAS. | PESO | GARANTÍA
Blister | 5/50 | 0.15 Kg | 3 meses **1 pza.**



18"
PFL-18 AA02053
EMPAQUE | PZAS. | PESO | GARANTÍA
Blister | 5/50 | 0.16 Kg | 3 meses **1 pza.**



19"
PFL-19 AA02054
EMPAQUE | PZAS. | PESO | GARANTÍA
Blister | 5/50 | 0.21 Kg | 3 meses **1 pza.**



Incluye adaptadores para conector tipo PIN: Bayoneta y Gancho
Include adaptor type PIN: Bayonet and Hook



21"
PFL-21 AA02055
EMPAQUE | PZAS. | PESO | GARANTÍA
Blister | 5/50 | 0.16 Kg | 3 meses **1 pza.**



22"
PFL-22 AA02091
EMPAQUE | PZAS. | PESO | GARANTÍA
Blister | 5/50 | 0.19 Kg | 3 meses **1 pza.**



24"
PFL-24 AA02092
EMPAQUE | PZAS. | PESO | GARANTÍA
Blister | 5/50 | 0.2 Kg | 3 meses **1 pza.**

Limpiaparabrisas

WINDSHIELD WIPERS



11"
PLP-11 AA02056
EMPAQUE | PZAS. | PESO | GARANTÍA
Blister | 5/50 | 0.2 Kg | 3 meses **1 par**

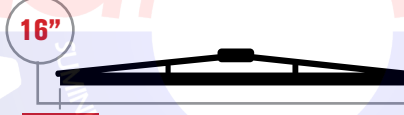

16"
PLP-16 AA02057
EMPAQUE | PZAS. | PESO | GARANTÍA
Blister | 5/50 | 0.27 Kg | 3 meses **1 par**

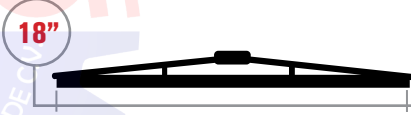

18"
PLP-18 AA02058
EMPAQUE | PZAS. | PESO | GARANTÍA
Blister | 5/50 | 0.31 Kg | 3 meses **1 par**

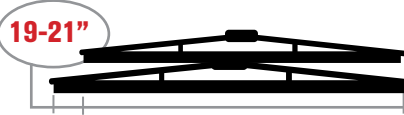

19-21"
PLP-1921 AA02059
EMPAQUE | PZAS. | PESO | GARANTÍA
Blister | 5/50 | 0.34 Kg | 3 meses **1 par**

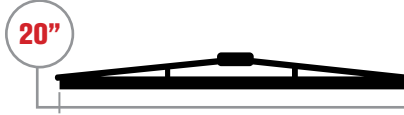

20"
PLP-20 AA02060
EMPAQUE | PZAS. | PESO | GARANTÍA
Blister | 5/50 | 0.35 Kg | 3 meses **1 par**

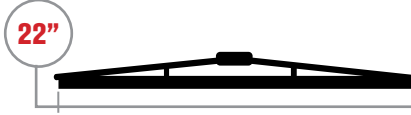

22"
PLP-22 AA02061
EMPAQUE | PZAS. | PESO | GARANTÍA
Blister | 5/50 | 0.4 Kg | 3 meses **1 par**

Empaque individual

Individual package

PLP-24 AA02062
EMPAQUE | PZAS. | PESO | GARANTÍA
Blister | 5/50 | 0.3 Kg | 3 meses **1 pza.**



Incluyen adaptadores para conector tipo PIN:
Bayoneta y Gancho
Include adaptor type PIN: Bayonet and Hook





Accesorios Automotrices / AUTOMOTIVE ACCESSORIES

Seguros para Rines WHEEL LOCKS

Tuerca
Nut



12mm x 1.5

SPR-2 AA02065	EMPAQUE	PZAS.	PESO	GARANTÍA
	Blister	10/40	0.5 Kg	3 meses

1/2" x 2

SPR-3 AA02066	EMPAQUE	PZAS.	PESO	GARANTÍA
	Blister	10/40	0.48 Kg	3 meses

12mm x 1.25

SPR-5 AA02068	EMPAQUE	PZAS.	PESO	GARANTÍA
	Blister	10/40	0.5 Kg	3 meses

14mm x 2

SPR-7 AA02070	EMPAQUE	PZAS.	PESO	GARANTÍA
	Blister	10/40	0.5 Kg	3 meses

14mm x 1.5

SPR-8 AA02071	EMPAQUE	PZAS.	PESO	GARANTÍA
	Blister	10/40	0.5 Kg	3 meses

Ambos Diseños incluyen **4 seguros y 2 llaves**. Cuentan con sistema de cabeza giratoria para maximizar la seguridad, ya que evitan que los seguros puedan ser extraídos con llaves y pericos.
Both models includes 4 locks and 2 keys. Have loose type head to maximize security, because make impossible the extraction with a wrench.

Birlo
External Thread



14mm x 1.5

SPR-1 AA02070	EMPAQUE	PZAS.	PESO	GARANTÍA
	Blister	10/40	0.6 Kg	3 meses

12mm x 1.5

SPR-4 AA02067	EMPAQUE	PZAS.	PESO	GARANTÍA
	Blister	10/40	0.54 Kg	3 meses

Cabeza giratoria
Loose type head



12mm x 1.25

SPR-6 AA02069	EMPAQUE	PZAS.	PESO	GARANTÍA
	Blister	10/40	0.54 Kg	3 meses

Accesorios Neumáticos / PNEUMATIC ACCESSORIES

Juego de Accesorios

Accessories set
7 PIEZAS

Incluye:
• Pistola para Sopletear • Aguja para Inflar balones • 5 boquillas



USOS: • Extensión
• Adaptador para aguja
• Sopleteado difuso
• Sopleteado concentrado
• Conexión directa a otra manguera

JAN-7 AA19006	EMPAQUE	PZAS.	PESO	GARANTÍA
	Blister	10/100	0.1 Kg	1 año

Juego de Accesorios

Accessories set
20 PIEZAS

Incluye:
• Manguera de espiral plegable de 7.5 m
• Calibrador profesional
• Calibrador tipo pluma
• Cople de 3/4"
• 2 coples de conexión rápida hembra
• Tres coples de conexión rápida macho
• 2 Boquillas para balón
• Adaptador universal 1/4" NPT
• Boquilla en punta engomada
• Boquilla inflantantas
• Válvula de seguridad
• Pistola de aire
• 2 coples hembra de 1/4" NPT.
• Válvula cónica
• Cinta teflón



JAN-14 AA19005	EMPAQUE	PZAS.	PESO	GARANTÍA
	Blister	10	0.8 Kg	1 año

Conexión de presión rápida

Quick Connection
1/4" NPT

Macho y hembra.
Acero inoxidable.
Male and female.
Stainless steel.



CPR-1 AA19004	EMPAQUE	PZAS.	PESO	GARANTÍA
	Blister	50/100	0.1 Kg	6 meses

Conexión de presión rápida

3 salidas
3 outlet pneumatic quick connector



CPR-3 AA19023	EMPAQUE	PZAS.	PESO	GARANTÍA
	Blister	6/24	0.2 Kg	6 meses

Válvula para Inflado de llantas

Tire inflator valve
15 BAR
217 PSI
1/4" NTP



VINFCO-14 AA19019	EMPAQUE	PZAS.	PESO	GARANTÍA
	Blister	10/100	0.1 Kg	1 año





Accesorios Neumáticos y Calibradores de Presión / PNEUMATIC ACCESSORIES AND PRESSURE GAUGES

De carátula rango 0-100 psi

Analog type pressure gauge
Botón de desfogue
Reset Button



C-1 AA22001

EMPAQUE	PZAS.	PESO	GARANTÍA
Blisters	48/288	0.05 Kg	3 meses

Profesional de carátula cromado rango 0-160 psi

Dial type pressure gauge
HD



Botón de desfogue
Reset Button

CCP-60 AA22002

EMPAQUE	PZAS.	PESO	GARANTÍA
Blisters	100/500	0.2 Kg	3 meses

Digital rango 0-150 psi

Digital pressure gauge



Incluye Baterías
Battery included

CPD-1 AA22006

EMPAQUE	PZAS.	PESO	GARANTÍA
Blisters	12/24	0.08 Kg	3 meses

De lujo tipo pluma rango 0-120 psi

Professional air pressure gauge



CL-1 AA22004

EMPAQUE	PZAS.	PESO	GARANTÍA
Blisters	100/500	0.04 Kg	3 meses

Profesional rango 0-100 psi

Professional air pressure gauge

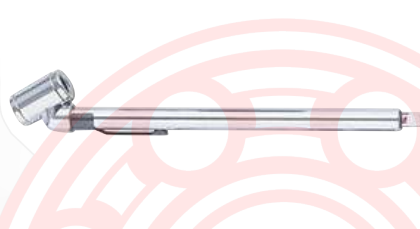

CP-1 AA22005

EMPAQUE	PZAS.	PESO	GARANTÍA
Blisters	100/400	0.06 Kg	3 meses

Profesional uso rudo rango 0-200 psi

Heavy duty pressure gauge metal gauge

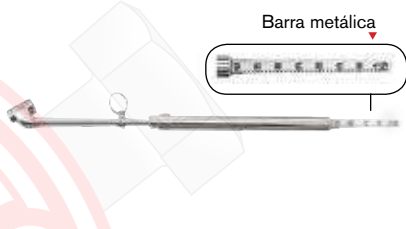

CPUR-200 AA22007

EMPAQUE	PZAS.	PESO	GARANTÍA
Blisters	12	0.14 Kg	3 meses

Profesional rango 0-160 psi

Professional air pressure gauge
HD



CCPM-160 AA22003

EMPAQUE	PZAS.	PESO	GARANTÍA
Blisters	6/36	0.3 Kg	3 meses

Pistola metálica para sopleteado

Metallic Air gun
1/4" NPT



Gatillo Antiderrapante
Anti Slip trigger

PIMSO-14 AA19016

EMPAQUE	PZAS.	PESO	GARANTÍA
Blisters	10/100	0.1 Kg	3 meses

Pistola para sopleteado

Air gun



PIMSO-10 AA19020

EMPAQUE	PZAS.	PESO	GARANTÍA
Blisters	6/36	0.1 Kg	3 meses

Pistola para inflado de llantas con manómetro

Tire inflating gun with manometer
220 PSI



PIM-220 AA19022

EMPAQUE	PZAS.	PESO	GARANTÍA
Blisters	6/24	0.06 Kg	1 año

Indicadores de presión para llantas

Air tire valve



IPL-4 AA02110

EMPAQUE	PZAS.	PESO	GARANTÍA
Blisters	20	0.1 Kg	3 meses

Inflallantas con manómetro

Tire inflator with manometer

**15 BAR
217 PSI
1/4 NPT**



INFM-220 AA05015

EMPAQUE	PZAS.	PESO	GARANTÍA
Blisters	10/40	0.4 Kg	1 año





Bancos y Camas para Mecánico / MECHANIC STOOLS AND CREEPERS

Banco con pistón y depósito para herramientas ajustable
Adjustable stool with piston and tool tray

130 kg



BMA-2	AA08003		
EMPAQUE	PZAS.	PESO	GARANTÍA
Caja Color	1	6 Kg	6 meses

Banco de trabajo acolchonado
Cushioned work stool

130 kg



BT-4	AA08005		
EMPAQUE	PZAS.	PESO	GARANTÍA
Caja	1	4.9 Kg	6 meses

Banco de trabajo con respaldo
Work stool with back rest

150 Kg



BTR-4	AA08051		
EMPAQUE	PZAS.	PESO	GARANTÍA
Caja	1	9 Kg	1 año

Cama acolchonada con 6 ruedas giratorias

6 Caster creeper
130 kg / 36" Largo



CM-2	AA08007		
EMPAQUE	PZAS.	PESO	GARANTÍA
Caja	1	7.2 Kg	6 meses

Banco con depósito para herramientas 4 ruedas
Work stool with tool tray

130 kg



BM-2	AA08002		
EMPAQUE	PZAS.	PESO	GARANTÍA
Caja	1	4.8 Kg	6 meses

Cama acolchonada con respaldo 3 posiciones y 6 ruedas giratorias

3 Position headrest creeper with 6 casters wheels
130 kg / 40" Largo



CM-3	AA08008		
EMPAQUE	PZAS.	PESO	GARANTÍA
Caja	1	7.6 Kg	6 meses

Cama acolchonada plegable con 6 ruedas giratorias

Foldable creeper 6 casters
130 kg / 36" Largo



CM-4	AA08009		
EMPAQUE	PZAS.	PESO	GARANTÍA
Caja	1	6.8 Kg	6 meses

Cama termoformada con 6 ruedas giratorias
Thermoformed creeper with 6 casters

120 kg / 36" Largo



CPM-36	AA08012		
EMPAQUE	PZAS.	PESO	GARANTÍA
Caja	1	4.5 Kg	6 meses

Cama termoformada con 6 ruedas giratorias
Thermoformed creeper with 6 casters

140 kg / 40" Largo



CPM-40	AA08014		
EMPAQUE	PZAS.	PESO	GARANTÍA
Caja	1	6.7 Kg	6 meses





desde 1960

Barras Transversales y Canastilla Porta Equipaje / CROSS BARS AND LUGGAGE CARRIER

Barras porta equipaje

Cross bars

60 Kg



- Adaptable a SUV's, CUV's, Autos de 2 y 4 puertas
- Fabricadas en metal con recubrimiento de plástico
- Bases ligeras de plástico

BU-T AA02005

EMPAQUE	PZAS.	PESO	GARANTÍA
Caja Color	1	4.4 Kg	6 meses



Incluye accesorios de sujeción
Accesories included

Canastilla porta equipaje

Luggage carrier

Incluye accesorios de sujeción
Accesories included

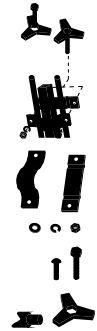

CPE AA02020

EMPAQUE	PZAS.	PESO	GARANTÍA
Caja Color	1	13.8 Kg	6 meses

Bolsas y Cajas Protectoras de Equipaje / CARGO BAGS AND CARGO BOX

Bolsa protectora

Cargo Bag

324 litros



CB-10 AA02016

EMPAQUE	PZAS.	PESO	GARANTÍA
Caja Color	8	2.8 Kg	6 meses

Incluyen bolsa para guardado, red de carga y candado de combinación.
Accesories included

Bolsa protectora JUMBO

Cargo Bag

450 litros



CBJ-12 AA02017

EMPAQUE	PZAS.	PESO	GARANTÍA
Caja Color	6	3.3 Kg	6 meses

Incluyen bolsa para guardado, red de carga y candado de combinación.
Accesories included

Cargo box rígida

Cargo Box

Mediana

320 litros



Incluye accesorios de sujeción
Accesories included



CBR-420 AA02018

EMPAQUE	PZAS.	PESO	GARANTÍA
Caja Color	1	14.5 Kg	6 meses



Cargo box rígida

Cargo Box

Grande

360 litros



Incluye accesorios de sujeción
Accesories included



CBR-500 AA02019

EMPAQUE	PZAS.	PESO	GARANTÍA
Caja Color	1	15.2 Kg	6 meses





Carretes y Mangueras para Aire a Presión / HOSE REELS FOR COMPRESSED AIR

Carretes de acero con sistema retráctil

Steel hose reel with retractable system
1/4"
15 m



Uso para agua y aire, presión máxima de trabajo 350 PSI

CAM-3	AA19003	EMPAQUE	PZAS.	PESO	GARANTÍA
Caja Color	1	17 Kg	3 meses		

Carretes de acero con sistema retráctil

Steel hose reel with retractable system
3/8"
15 m



Uso para agua y aire, presión máxima de trabajo 350 PSI

CAM-2	AA19002	EMPAQUE	PZAS.	PESO	GARANTÍA
Caja Color	1	19.8 Kg	3 meses		

Carretes de acero con sistema retráctil

Steel hose reel with retractable system
1/2"
15 m



Uso para agua y aire, presión máxima de trabajo 350 PSI

CAM-1	AA19001	EMPAQUE	PZAS.	PESO	GARANTÍA
Caja Color	1	22.8 Kg	3 meses		

Mangueras para aire PVC

High-pressure hoses
1/4" X 15 m
1/4" NPT
300 PSI



Conexiones hembra y macho de latón 6.35 mm

MAP-1415	AA19010	EMPAQUE	PZAS.	PESO	GARANTÍA
Funda	6	1.8 Kg	1 año		

Mangueras para aire PVC

High-pressure hoses
3/8" X 10 m
1/4" NPT
300 PSI



Conexiones hembra y macho de latón 6.35 mm

MAP-3810	AA19011	EMPAQUE	PZAS.	PESO	GARANTÍA
Funda	6	1.7 Kg	1 año		

Mangueras para aire PVC

High-pressure hoses
3/8" X 15 m
1/4" NPT
300 PSI



Conexiones hembra y macho de latón 6.35 mm

MAP-3815	AA19012	EMPAQUE	PZAS.	PESO	GARANTÍA
Funda	6	2.4 Kg	1 año		

Mangueras para aire PVC

High-pressure hoses
1/2" X 10 m
1/2" NPT
300 PSI



Conexiones hembra y macho de latón 6.35 mm

MAP-1210	AA19007	EMPAQUE	PZAS.	PESO	GARANTÍA
Funda	6	2.4 Kg	1 año		

Mangueras para aire PVC

High-pressure hoses
1/2" X 15 m
1/2" NPT
300 PSI



Conexiones hembra y macho de latón 6.35 mm

MAP-1215	AA19008	EMPAQUE	PZAS.	PESO	GARANTÍA
Funda	6	3.5 Kg	1 año		

Mangueras para aire PVC

High-pressure hoses
1/2" X 20 m
1/2" NPT
300 PSI



Conexiones hembra y macho de latón 6.35 mm

MAP-1220	AA19009	EMPAQUE	PZAS.	PESO	GARANTÍA
Funda	4	4.6 Kg	1 año		

Manguera de PVC Neumática a granel

Pneumatic hose reel bulk
1/4" X 200 m



MNG-14	AA19014	EMPAQUE	PZAS.	PESO	GARANTÍA
Granel	1	24.2 Kg	1 año		

Manguera de PVC Neumática a granel

Pneumatic hose reel bulk
3/8" X 200 m



MNG-38	AA19015	EMPAQUE	PZAS.	PESO	GARANTÍA
Granel	1	31.2 Kg	1 año		

Manguera de PVC Neumática a granel

Pneumatic hose reel bulk
1/2" X 100 m



MNG-12	AA19013	EMPAQUE	PZAS.	PESO	GARANTÍA
Granel	1	23 Kg	1 año		



Cables pasa corriente / BOOSTER CABLES

*Todos los modelos MIKEL'S incluyen: • Bolsa individual • Pinzas con pintura electrostática • Puntas de cobre • Cable dúplex
• Individual Bag • Clamps with powder coat paint • Copper tip on the clamps • Duplex type cable



Calibre 10 2.40 m 210 Amp

C-240-10 AA02007

EMPAQUE	PZAS.	PESO	GARANTÍA
Caja Color	6	1.2 Kg	1 año



Calibre 10 3.60 m 140 Amp

C-360-10 AA02009

EMPAQUE	PZAS.	PESO	GARANTÍA
Caja Color	6	1.4 Kg	1 año



Calibre 8 2.40 m 340 Amp

C-240-8 AA02008

EMPAQUE	PZAS.	PESO	GARANTÍA
Caja Color	6	1.3 Kg	1 año



Calibre 8 3.60 m 240 Amp

C-360-8 AA02010

EMPAQUE	PZAS.	PESO	GARANTÍA
Caja Color	6	1.6 Kg	1 año



Calibre 4 4.80 m 300 Amp

C-480-4 AA02011

EMPAQUE	PZAS.	PESO	GARANTÍA
Caja Color	4	2.6 Kg	1 año

Calibre 10 2.40 m 180 Amp

C-240-10T BA02001

EMPAQUE	PZAS.	PESO	GARANTÍA
Funda	6/12	0.8 Kg	6 meses

Calibre 8 2.40 m 250 Amp

C-240-8T BA02002

EMPAQUE	PZAS.	PESO	GARANTÍA
Funda	6/12	0.9 Kg	6 meses

Calibre 10 2.20 m 180 Amp

C-220-10T BA02003

EMPAQUE	PZAS.	PESO	GARANTÍA
Funda	6/24	0.7 Kg	6 meses

Cinturones-Malacates Tensores / HOSE REELS FOR COMPRESSED AIR

Eslinga remolcadora

Tow rope

2"
1.5 t
4 m



SCT-1 AA13005

EMPAQUE	PZAS.	PESO	GARANTÍA
Bolsa	16	0.6 Kg	6 meses

Cinturón para sujetar carga

Load Holding Tie Down

2"
1.5 t
4.5 m



- Estructura de acero templado con acabado tropicalizado
- Dispositivo manual de tensión
- Ganchos reforzados en cada extremo

Steel construction, with galvanized finish
Manual tension device Reinforced hooks on each end

TDB-45 AA13009

EMPAQUE	PZAS.	PESO	GARANTÍA
Colgador	6	2.1 Kg	6 meses

Cinturón para sujetar carga

Load Holding Tie Down

2"
1.5 t
9 m



- Estructura de acero templado con acabado tropicalizado
- Dispositivo manual de tensión
- Ganchos reforzados en cada extremo

Steel construction, with galvanized finish
Manual tension device Reinforced hooks on each end

TDB-90 AA13010

EMPAQUE	PZAS.	PESO	GARANTÍA
Colgador	6	2.4 Kg	6 meses

Banda para malacate tensor

Truck Winch Strap

4"
3 t
9 m



BMT-4 AA13001

EMPAQUE	PZAS.	PESO	GARANTÍA
Blistier	6	2 Kg	6 meses

Malacate tensor soldable

Cargo Winch - Welded type

4"



MT-4S AA13002

EMPAQUE	PZAS.	PESO	GARANTÍA
Fajilla	6	4 Kg	6 meses

Palanca para Malacate Tensor

Winch bar

100 cm

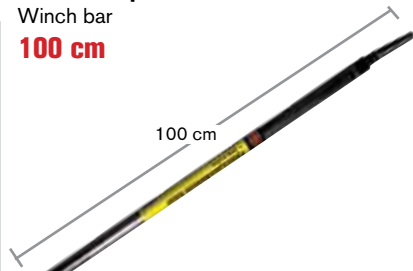

PMT AA13003

EMPAQUE	PZAS.	PESO	GARANTÍA
Granel	6	2.4 Kg	6 meses



Dados de Impacto Calidad Industrial (pavonados) / INDUSTRIAL QUALITY IMPACT SOCKETS

17 mm x 1/2"



Pared Delgada



DI-S17 AA14002

EMPAQUE	PZAS.	PESO	GARANTÍA
Caballote	10	0.2 Kg	1 año

3/4" x 1/2"



Pared Delgada



DI-S19 AA14003

EMPAQUE	PZAS.	PESO	GARANTÍA
Caballote	10	0.27 Kg	1 año

13/16" x 1/2"



Pared Delgada



DI-S21 AA14006

EMPAQUE	PZAS.	PESO	GARANTÍA
Caballote	10	0.25 Kg	1 año

7/8" x 1/2"



Pared Delgada



DI-S22 AA14007

EMPAQUE	PZAS.	PESO	GARANTÍA
Caballote	10	0.33 Kg	1 año

1 3/16" x 1"



DI-S30 AA14008

EMPAQUE	PZAS.	PESO	GARANTÍA
Caballote	4	0.8 Kg	1 año

1" x 33mm



UNEMON



DI-S33 AA14009

EMPAQUE	PZAS.	PESO	GARANTÍA
Caballote	1/4	0.98 Kg	1 año

13/16" x 1"



DI-S2 AA14005

EMPAQUE	PZAS.	PESO	GARANTÍA
Caballote	4	0.8 Kg	1 año

1 1/2" x 1"



DI-S1 AA14001

EMPAQUE	PZAS.	PESO	GARANTÍA
Caballote	4	1.18 Kg	1 año

Cuadro interior 13/16" 1 1/2" x 1"



DI-S1C AA14004

EMPAQUE	PZAS.	PESO	GARANTÍA
Caballote	4	1.5 Kg	1 año

Extractor de capuchón con hexágono exterior 1 1/2"



EC-D13 AA14010

EMPAQUE	PZAS.	PESO	GARANTÍA
Caballote	10	0.6 Kg	N/A

Dados de impacto juego de 3 pzs

3 pz. impact sockets set

17,19 y 21 mm

Pared delgada con protección plástica

Ideal para Rines de Aleación

JDI-3 AA14013

EMPAQUE	PZAS.	PESO	GARANTÍA
Colgador	6/24	0.5 Kg	1 año



17 mm 11/16"

19 mm 3/4"

21 mm 13/16"

NEW!

Elevadores Electro-Hidráulicos / ELECTRO HYDRAULIC LIFTER

Rampa elevadora portátil

2,500 kg portable lift

2500 Kg

1500 mm

300 mm



Velocidad de elevación 35 s

Velocidad de descenso 25 s

Altura máxima 45 cm

Altura mínima 8 cm

REP-2500 AA15005

EMPAQUE	PZAS.	PESO	GARANTÍA
Caja Madera	1/2	120 Kg	1 año

7821606595
7821604051
7821610766



contacto@sidadz.com



www.sidadz.com



mikels.com.mx | @mikels tools



desde 1960 Elevadores Electro-Hidráulicos / ELECTRO HYDRAULIC LIFTER

Rampa elevadora para estacionamiento 2 postes

Twin post parking lift

2,300 kg



MODELO / MODEL	REE-2300	
Levante Máximo / Max Height	m	3.5
Levante de la plataforma / Platform Height	m	2.1
Distancia entre postes / Between Post	m	2.1
Tiempo de Levante / Lifting time	seg	60
Tiempo de Descenso / Lowering Time	seg	20
Máxima Capacidad por Plataforma / Max	Kg	2300
Motor / Motor Power	HP	2
Voltaje / Volts	V/Hz	220 / Bifásico

Altura mínima requerida para instalación

AUTO/AUTO: 3.70 m	CAMIONETA/AUTO: 3.80 m	CAMIONETA / CAMIONETA: 4.20 m
-------------------	------------------------	-------------------------------



REE-2300 AA15004

EMPAQUE	PZAS.	PESO	GARANTÍA
Granel	1	750 Kg	1 año

MEDIDAS

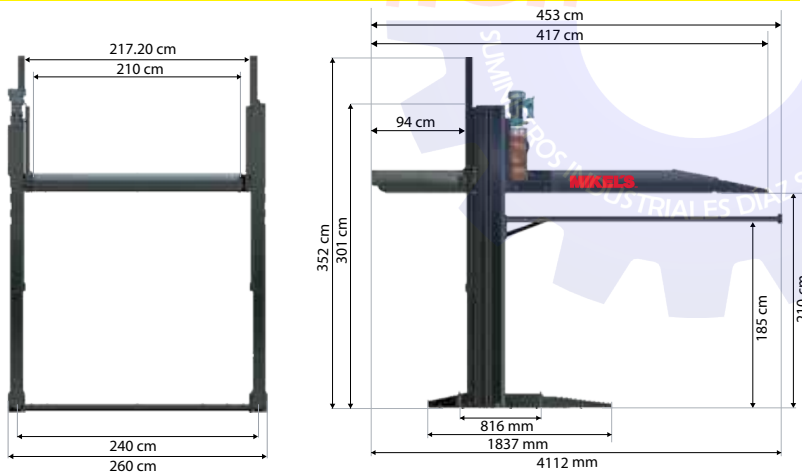

Elevación inmejorable
En la parte inferior de la plataforma se pueden colocar las camionetas mas altas del mercado



Especificaciones para instalación

Para instalaciones en serie, las rampas comparten un poste para economizar espacio al unirse entre si.





Elevadores Electro-Hidráulicos / ELECTRO HYDRAULIC LIFTER

Rampa elevadora para estacionamiento 4 postes

Parking lift

3,000 kg



REE-300 AA15003

EMPAQUE	PZAS.	PESO	GARANTÍA
Granel	1	773 Kg	1 año

MODELO / MODEL		REE-300
Elevación Máxima sobre la plataforma / Max Height over the rail	cm	1860
Altura Libre bajo la plataforma / Free Clearance under the rail	mm	1760
Largo Total / Total lenght	mm	4454
Ancho externo sobre carriles / Over the rails width	mm	1910
Ancho entre carriles / Width between the rails	mm	473
Ancho total interior de los postes / Total width inside the post	mm	2375
Ancho total exterior de los postes / Total width outside the post	mm	2667
Altura total del poste / Post total height	mm	2230
Tiempo de levante / Lifting time	seg	50
Tiempo de descenso / Lowering time	seg	20
Capacidad Máxima / Max. Capacity	kg	3000
Motor / Motor Power	hp	3
Especificación eléctrica / Electric Spec	V/Hz	110/60

MEDIDAS

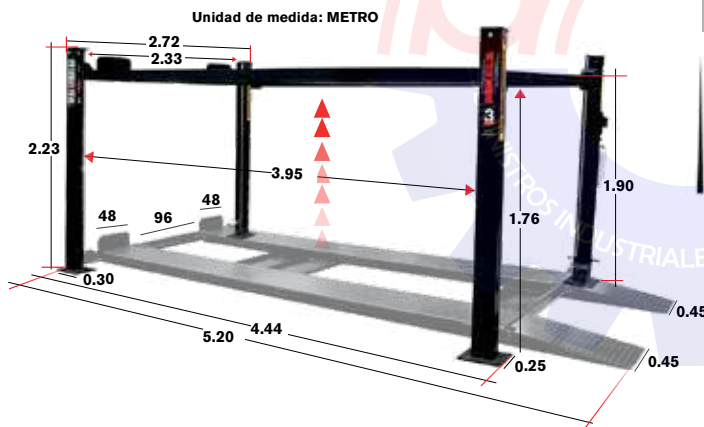

Altura mínima requerida para instalación

AUTO/AUTO: **3.40 m** CAMIONETA/AUTO: **3.50 m** CAMIONETA / CAMIONETA: **3.90 m**



El sistema de liberación de los seguros requiere un compresor de aire de 2HP mínimo, te recomendamos nuestro compresor de aire MIKEL'S Mod. CA-2HP (pag.85)

Especificaciones para instalación



Instalación en Batería:
Rampas en traslape, bombas al frente 10.65 m

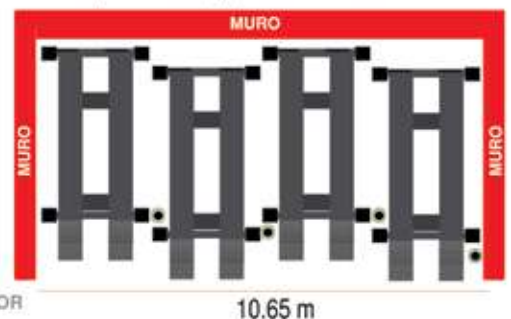

desde 1960 **Elevadores Electro-Hidráulicos / ELECTRO HYDRAULIC LIFTER**

Elevador 2 postes asimétrico sin travesaño

Twin post asymmetric lifter without gantry

6,600 lb
3,000 kg



SIN TRAVESAÑO
PERMITE ELEVAR AUTOMÓVILES
Y CAMIONETAS DE GRAN TAMAÑO
A MAYOR ALTURA

EMPAQUE	PZAS.	PESO	GARANTÍA
Granel	1	565 Kg	1 año

Características

- Práctico sistema sin obstáculos para la altura del vehículo a elevar.
- Permite abrir las puertas del vehículo.
- Cuenta con seguros para distintas alturas, fácil de utilizar.

- Permite trabajar debajo del automóvil.
- Cuenta con sensor de seguridad.
- Sistema mecánico de seguridad cada 10.2 cm. Bomba electrohidráulica

- Practical system without height limit of the vehicle allows to open the doors of the vehicle.
- Comes with safety locks for different heights, easy to use.

- Allows to work underneath the vehicle.
- Comes with safety sensor.
- Mechanic safety lock system every 10.2 cm
- Electrohydraulic Pump

MODELO / MODEL	EA-6600	
Levante Máximo / Max Height	m	1.7
Altura Total / Total Height	m	2.70
Distancia Externa Entre Postes / Outside Distance Between Post	m	3.26
Distancia Interna Entre Postes / Inside Distance Between Post	m	2.72
Tiempo de Levante / Lifting time	seg	50
Tiempo de Descenso / Lowering Time	seg	20
Motor / Motor Power	HP	3
Voltaje / Volts	V / Hz	220 / 60

Tiempo de ascenso: 50 seg.

Tiempo de descenso: 20 seg.

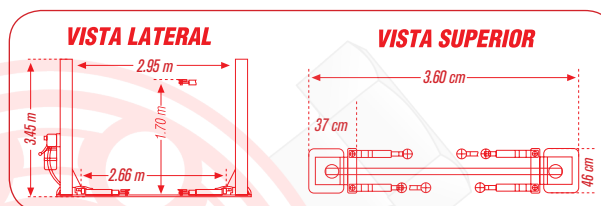

Elevador 2 postes asimétrico con travesaño

Twin post asymmetric lift

10,000 lb
4,536 kg



PISO LIBRE
PERMITE MOVER HERRAMIENTAS
LIBREMENTE DEBAJO DEL
VEHICULO ELEVADO

EMPAQUE	PZAS.	PESO	GARANTÍA
Granel	1	955 Kg	1 año

Características

- Permite abrir las puertas del vehículo.
- Cuenta con seguros para distintas alturas, fácil de utilizar.
- Permite trabajar debajo del automóvil.

- Cuenta con sensor de seguridad.
- Sistema mecánico de seguridad cada 10.2 cm.
- Bomba electrohidráulica

- Allows to open the doors of the vehicle.
- Comes with safety locks for different heights, easy to use.
- Allows to work underneath the vehicle.

- Comes with safety sensor.
- Mechanic safety lock system every 10.2 cm
- Electrohydraulic Pump

MODELO / MODEL	EA-10000	
Levante Máximo / Max Height	m	1.70
Altura Total / Total Height	m	3.68
Distancia Externa Entre Postes / Outside Distance Between Post	m	3.49
Distancia Interna Entre Postes / Inside Distance Between Post	m	2.90
Tiempo de Levante / Lifting time	seg	50
Tiempo de Descenso / Lowering Time	seg	20
Motor / Motor Power	HP	3
Voltaje / Volts	V / Hz	220 / 60

Tiempo de ascenso: 50 seg.

Tiempo de descenso: 20 seg.

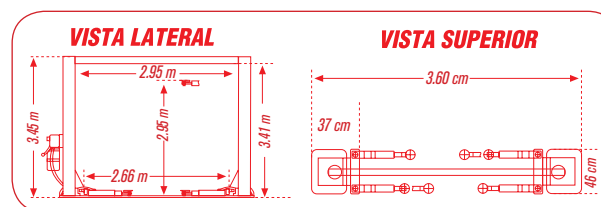



Equipos de Emergencia /EMERGENCY EQUIPMENT

Conos de seguridad

Safety Cone

45 cm



CS-45 AA28002

EMPAQUE	PZAS.	PESO	GARANTÍA
Granel	1/5	1.2 Kg	3 meses

Conos de seguridad

Safety Cone

70 cm



CS-70 AA28004

EMPAQUE	PZAS.	PESO	GARANTÍA
Granel	1/5	2.4 Kg	3 meses

Triángulos reflejantes

Warning triangles

1 PAR
10"

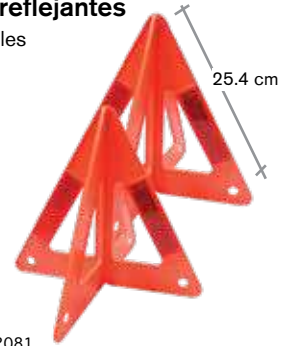

TR-10 AA02081

EMPAQUE	PZAS.	PESO	GARANTÍA
Bolsa	70	0.1 Kg	3 meses

Conos de seguridad con reflejante

Safety Cone with reflective collar

45 cm



CS-45R AA28003

EMPAQUE	PZAS.	PESO	GARANTÍA
Granel	1/5	1 Kg	3 meses

Conos de seguridad con reflejante

Safety Cone with reflective collar

70 cm



CS-70R AA28005

EMPAQUE	PZAS.	PESO	GARANTÍA
Granel	1/5	2.3 Kg	3 meses

Triángulo reflejante

Warning triangle

10"



TR-10Z AA02082

EMPAQUE	PZAS.	PESO	GARANTÍA
Termosellado	1	0.4 Kg	3 meses

Triángulos reflejantes

Warning triangles

10"

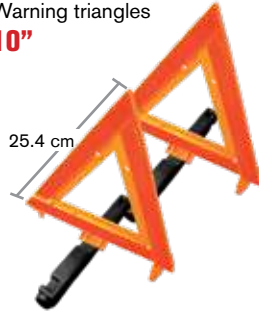

TRI-10DB AA02085

EMPAQUE	PZAS.	PESO	GARANTÍA
Blister	12	1 Kg	3 meses

Triángulo reflejante económico

Warning triangle

17"

Incluye Estuche



TR-17E AA02082

EMPAQUE	PZAS.	PESO	GARANTÍA
Estuche	1/5	0.2 Kg	3 meses

Triángulo reflejante

Warning triangle

17"



TR-17A AA02084

EMPAQUE	PZAS.	PESO	GARANTÍA
Funda	1	1.6 Kg	3 meses

Triángulos reflejantes estuche incluido

Warning triangles vinyl bag included

17"



TR-17 AA02083

EMPAQUE	PZAS.	PESO	GARANTÍA
Caja Color	1	3.5 Kg	1 año

Tanques metálicos para gasolina

Metal gas tanks

5 lts

Incluye Manguera Flexible



TG-5 AA02080

EMPAQUE	PZAS.	PESO	GARANTÍA
Caja Color	6	1.5 Kg	1 año

Tanques metálicos para gasolina

Metal gas tanks

10 lts

Incluye Manguera Flexible



TG-10 AA02078

EMPAQUE	PZAS.	PESO	GARANTÍA
Caja Color	4	3.4 Kg	2 años

Tanques metálicos para gasolina

Metal gas tanks

20 lts

Incluye Manguera Flexible



TG-20 AA02079

EMPAQUE	PZAS.	PESO	GARANTÍA
Caja Color	4	4 Kg	2 años



desde 1960 **Equipos para Mecánico / MECHANIC SHOP EQUIPMENT**

Topes para estacionamiento
Wheel stopper

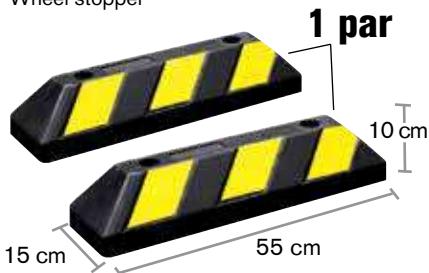

Incluye:
• 4 tornillos de 10mm X 100 mm
• 4 taquetes de 14mm X 175 mm

TE-55 AA28007

EMPAQUE	PZAS.	PESO	GARANTÍA
Caja	1 par	8.4 Kg	1 año

Charola magnética rectangular

Rectangular magnetic tray

14 x 24 cm

Acero inoxidable, magneto recubierto, ideal para usar boca abajo.



CMR-1 AA08011

EMPAQUE	PZAS.	PESO	GARANTÍA
Blister	20	0.7 Kg	1 año

Dolly para auto

Car dollies

454 kg

Capacidad 454 kg en cada dolly.

Medidas: 38.7 cm X 59 cm

Capacity: 454 kg on each dolly.

Measures: 38.7 cm X 59 cm



D-1 AA08014

EMPAQUE	PZAS.	PESO	GARANTÍA
Caja	1 par	20.5 Kg	1 año

Tina limpia partes de motor

Cleaning parts tub

20 Gal.
127 V
60 Hz
0.5 A
110 VCA



TLM-1 AA08031

EMPAQUE	PZAS.	PESO	GARANTÍA	CONEXIÓN
Caja	1	27 Kg	1 año	Contacto

Tina de limpieza por ultrasonido

Ultrasonic cleaning tub

3 LITROS



TLU-3 AA08063

EMPAQUE	PZAS.	PESO	GARANTÍA	CONEXIÓN
Caja	6	3.6 Kg	1 año	Contacto

Tina de limpieza por ultrasonido

Ultrasonic cleaning tub

10 LITROS



TLU-10 AA08064

EMPAQUE	PZAS.	PESO	GARANTÍA	CONEXIÓN
Caja	1	7.7 Kg	1 año	Contacto

Compactador neumático para filtros de aceite

Pneumatic Oil filter Crusher

10 t



CFN-10 AA16016

EMPAQUE	PZAS.	PESO	GARANTÍA
Caja	1	65 Kg	1 año

Carrito de servicio con triple charola

Triple tray tool cart

100 kg



CS-3 AA18002

EMPAQUE	PZAS.	PESO	GARANTÍA
Caja	1	15 Kg	1 año

Desengrasante multiusos biodegradable

Multi-purpose biodegradable degreaser

5 lts



DMB-5 AA21013

EMPAQUE	PZAS.	PESO
Caja	1/2	10.6 Kg



Equipos para Mecánico / MECHANIC SHOP EQUIPMENT

Rampas Troqueladas

Car ramps

3 t

Sólida Construcción
de Acero calibre 14

1 par

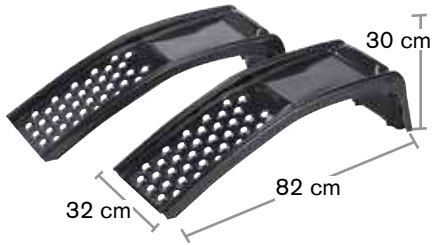

RT-3 AA08021

EMPAQUE	PZAS.	PESO	GARANTÍA
Caja	1	6 Kg	1 año

Mesa de trabajo con ruedas

Work table with wheels

23 kg



- Altura ajustable
- Con tapete de hule antiderrapante
- Estructura tubular de acero reforzado

MT-23 AA18004

EMPAQUE	PZAS.	PESO	GARANTÍA
Caja	1	23 Kg	1 año

Estante y Caja para Herramientas COMBO

Tool cabinet & tool box combo



CEC-02 BA18001

EMPAQUE	PZAS.	PESO	GARANTÍA
Caja	1	30 Kg	1 año

Caja para herramientas

6 Drawer tool chest

6 CAJONES

- Espesor de la lámina: Calibre 18
- Incluye charola de: 49 cm x 7.7 cm x 20.4 cm
- Correderas con baleros
- Steel gauge: 1 mm
- Tray: 49 cm x 7.7 cm x 20.4 cm
- Bell bearing slides



CH-1 AA18001

EMPAQUE	PZAS.	PESO	GARANTÍA
Caja	1	26.6 Kg	1 año

Estante para herramientas

6 Drawer tool cabinet

6 CAJONES

- Espesor de la lámina: Calibre 16
- Correderas con baleros
- Steel gauge: 1.5 mm
- Bell bearing slides

MEJORADO



EH-1 AA18003

EMPAQUE	PZAS.	PESO	GARANTÍA
Caja	1	60 Kg	1 año

Gabinete modular para piso

Modular floor cabinet

- Espesor de la lámina: Calibre 18

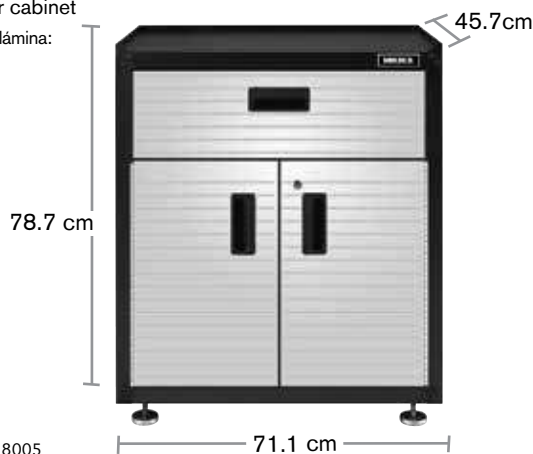

EMP-28 AA18005

EMPAQUE	PZAS.	PESO	GARANTÍA
Caja	1	28.5 Kg	1 año

Gabinete modular para pared

Modular wall cabinet

- Espesor de la lámina: Calibre 18
- Incluye
- Sistema de sujeción

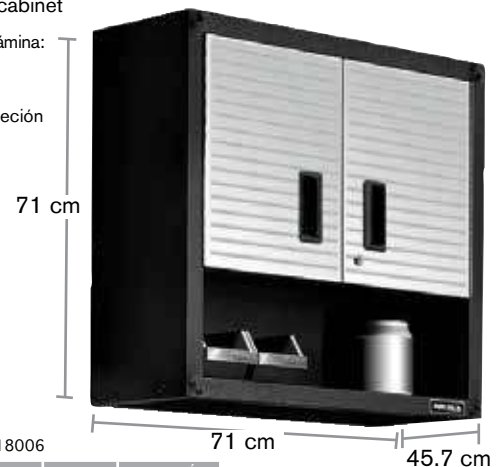

GMP-28 AA18006

EMPAQUE	PZAS.	PESO	GARANTÍA
Caja	1	32.8 Kg	1 año





Equipos de Enderezado / CAR BODY REPAIR SYSTEM

Porto power 4 t



•Incluye estuche de plástico para fácil almacenamiento.
•Includes plastic case for easy storage.

R-434 AA01068

EMPAQUE	PZAS.	PESO	GARANTÍA
Portafolio	1	19.5 Kg	6 meses

•Cuenta con 4 extensiones y 9 accesorios
•It comes with 4 extensions and 9 accessories

Porto power 10 t



•Incluye estuche de plástico para fácil almacenamiento.
•Includes plastic case for easy storage.

R-435 AA01069

EMPAQUE	PZAS.	PESO	GARANTÍA
Portafolio	1	34.7 Kg	6 meses

•Cuenta con 5 extensiones, 3 bases y 8 accesorios
•It comes with 5 extensions, 3 bases and 8 accessories

Porto power 20 t

•Incluye 4 extensiones y 13 accesorios
•Sistema roscable
•Includes a 4 extensions and 13 accessories
•All screw thread system



R-436 AA01070

EMPAQUE	PZAS.	PESO	GARANTÍA
Portafolio	1 pza (2 cajas)	33 Kg	6 meses

Carrito para transporte

Porto Power 10 t

•Incluye estuche de plástico para fácil almacenamiento.
•Includes plastic case for easy storage.



PPT-10 BA01016

EMPAQUE	PZAS.	PESO	GARANTÍA
Portafolio	1	32 Kg	6 meses

TIMER

Enderezador de Chasis Frame Straightener 10 t

• Empuje de 150 mm. ruedas de nylon
• Cuerpo de acero de 2.94 m. de largo, peso 205 kg.
• 2 cadenas de 2.8 m. de largo.
• Stroke: 150 mm. • Nylon wheels for easy transportation.
• 2.94 m. • steel structure. 1.60 m height post.
• Weight 205 kg. • Includes 2 chains of 2.8 meters. long each.

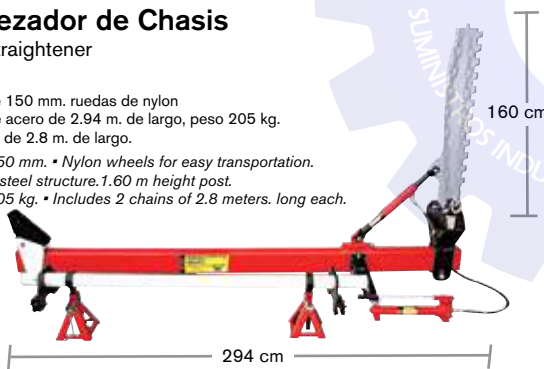

EC-10 AA01004

EMPAQUE	PZAS.	PESO	GARANTÍA
Caja	1	205 Kg	1 año

El brazo puede jalar a un ángulo de 45° lateralmente
The arm pulls 45° sideways

Bomba Hidroneumática acción simple Air foot pump

Rango de Presión: 10,000 psi
Pressure Rating
Puerto de Aceite: 3/8" NPT
Oil Port



No incluye Accesorios
Accessories not included



•Incluye manguera reforzada de 1.80 m. de largo, 1/2" de diámetro
•1.80 m. reinforced hose, 1/2" diameter

BH-9 AA16014

EMPAQUE	PZAS.	PESO	GARANTÍA
Caja	1	9.2 Kg	1 año

Cople para porto power Coupler 10 t



CP-10 AA01001

EMPAQUE	PZAS.	PESO	GARANTÍA
Blistir	200	0.1 Kg	1 año

Engrasadora de baleros profesional Professional Ball bearing greaser

Para engrasar baleros con diámetro desde 12.7 mm (1/2") hasta 152.4 mm (6") Exterior



EBP-625 AA09027

EMPAQUE	PZAS.	PESO	GARANTÍA
Caja	1	1.5 Kg	6 meses





Extintores de Emergencia / EMERGENCY FIRE EXTINGUISHERS

De aluminio no recargable
Polvo químico seco tipo ABC
ABC type
300 g



EMR-300	AA02033		
EMPAQUE	PZAS.	PESO	GARANTÍA
Caja Color	15	0.5 Kg	1 año

De aluminio no recargable
Polvo químico seco tipo ABC
ABC type
450 g



EMR-450	AA02034		
EMPAQUE	PZAS.	PESO	GARANTÍA
Caja Color	25	0.7 Kg	1 año

Recargable
Polvo químico seco tipo ABC
Refillable ABC type
500 g
•Incluye soporte
•Bracket included



EE-500	AA02032		
EMPAQUE	PZAS.	PESO	GARANTÍA
Caja Color	10	1.2 Kg	1 año

Recargable
Polvo químico seco tipo ABC
Refillable ABC type
1 kg
•Incluye soporte
•Bracket included



EE-1	AA02030		
EMPAQUE	PZAS.	PESO	GARANTÍA
Caja Color	10	2 Kg	1 año

Recargable
Polvo químico seco tipo ABC
Refillable ABC type
2 kg
•Incluye soporte
•Bracket included



EE-2	AA02031		
EMPAQUE	PZAS.	PESO	GARANTÍA
Caja Color	4	3.5 Kg	1 año

Equipo Llantero / TIRE CHANGING EQUIPMENT

Multiplicador de torque
Labor saving wrench
Torque 1,200 N.m. (850 Pie/Lb)
Rango de Esfuerzo 1:50



MT-1200	AA05051		
EMPAQUE	PZAS.	PESO	GARANTÍA
Portafolio	1/4	2.5 Kg	1 año

Juego de barras desmontadoras
Tire demounting tool
Para rines desde 17 1/2" - 24 1/2"



JBD-100	AA05016		
EMPAQUE	PZAS.	PESO	GARANTÍA
Caja	1	13.3 Kg	6 meses

Multiplicador de torque
Labor saving wrench
Torque 3,200 N.m. (2,360 Pie/Lb)
Rango de Esfuerzo 1:58



MT-3200	AA05027		
EMPAQUE	PZAS.	PESO	GARANTÍA
Portafolio	1/4	7.9 Kg	1 año

Incluye:
•2 dados de: 32 mm y 33 mm
•Cuadro de mando del dado: 1" (2.54 cm)

Multiplicador de torque
Labor saving wrench
Torque 6,000 N.m (4,425 Pie/Lb)
Rango de Esfuerzo 1:78



MT-6000	AA05049		
EMPAQUE	PZAS.	PESO	GARANTÍA
Portafolio	1/3	9.8 Kg	1 año

Incluye:
•2 dados de: 32 mm y 33 mm
•Cuadro de mando del dado: 1" (2.54 cm)
•Dado de extension





desde 1960

Equipo Llantero / TIRE CHANGING EQUIPMENT

Balancadora de llantas para auto

Wheel balancer

Rin de 12" a 24"



BALMK-1020 AA01078

EMPAQUE	PZAS.	PESO	GARANTÍA	CONEXIÓN
Caja	1	122 Kg	1 año	Contacto

Balancadora de llantas para auto alto volumen

Wheel balancer

Rin de 13" a 24"



BMK-1324 AA05003

EMPAQUE	PZAS.	PESO	GARANTÍA	CONEXIÓN
Caja	1	130 Kg	1 año	Contacto

Balancadora de llantas para camión

Truck wheel balancer

Capacidad de balanceo de ruedas hasta de

Rin 13" a 24"

150 KG DE PESO

Sin clavija



BCA-1324 AA05002

EMPAQUE	PZAS.	PESO	GARANTÍA	CONEXIÓN
Caja	1	273 Kg	1 año	Contacto

MODELO / MODEL		BALMK-1020	BMK-1324	BCA-1324
Peso Máximo de la rueda / Max Wheel weight	kg	65	65	150
Velocidad de Balanceo / Balancing speed	RPM	200	200	200
Diámetro de Rin / Rim Diameter	Pulg	12 a 24	13 a 24	14 a 24
Ancho del Rin / Rim width	PulgWT	1.5 a 20	1.5 a 20	5.5 a 20
Tiempo de Balanceo / Balancing time	Seg	8	8	8
Potencia Motor / Motor Power	HP	0.5	1	1.5





Equipo Lantero / TIRE CHANGING EQUIPMENT

Alineadora 3D

3D Wheel Alignment Machine

Rin de 12" a 24"

NEW!



Cámaras de amplio rango

Blancos reflejantes de Aluminio

Compactos y ligeros

PARÁMETRO DE MEDICIÓN	EXACTITUD	RANGO
Exactitud desplegada	2,5 cm (1") / 1 mm	
Camber	± 5 cm (2")	± 10°
Caster	± 15,2 cm (6")	± 20°
Inclinación del perno guía	± 15,2 cm (6")	± 20°
Toe	± 5 cm (2")	± 20°
Retroceso	± 5 cm (2")	± 5°
Ángulo de empuje	± 5 cm (2")	± 5°

AL-3D AA05050

EMPAQUE	PZAS.	PESO	GARANTÍA	CONEXIÓN
Caja Madera	1/2	180 Kg	1 año	Contacto

Gato Sacarruedas "YO-YO"

Hydraulic wheel dolly

500 kg

VISTA LATERAL

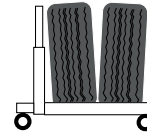

Elevación Máxima: 28 cm
Maximum Height

Altura Mínima: 6 cm
Minimum Height

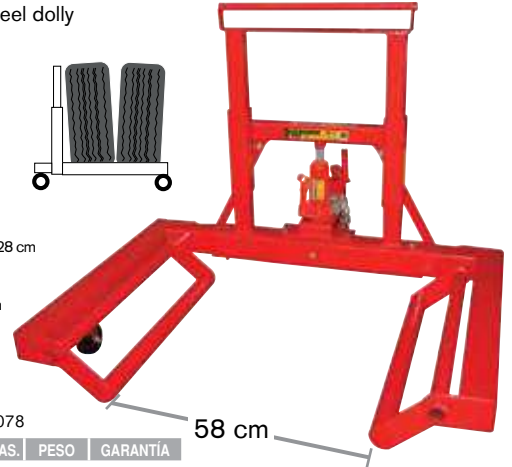

T-500 AA01078

EMPAQUE	PZAS.	PESO	GARANTÍA
Caja	1	68.5 Kg	1 año

Desmontadora manual de llantas para rines

Manual Tire changer

Rin de 8" a 24"



DM-824 AA05014

EMPAQUE	PZAS.	PESO	GARANTÍA
Caja	1	17.7 Kg	1 año



Rámpa elevadora de Alineación

Wheel Alignment Lift

4,000 KG

Incluye ROLLING JACK 2.5 t

NEW!

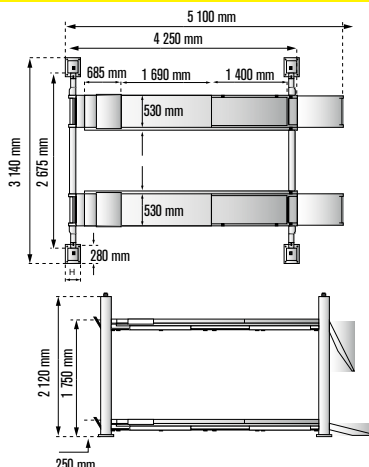

REA-4000 AA15006

EMPAQUE	PZAS.	PESO	GARANTÍA
Atado	1	220 Kg	1 año



mikels.com.mx | @mikels tools





desde 1960

Equipo Llantero / TIRE CHANGING EQUIPMENT

Desmontadora de llantas para rines

Tire changer
Rin de:
12" a 24"



DESMK-1020 AA05013

EMPAQUE	PZAS.	PESO	GARANTÍA	CONEXIÓN
Caja	1	190 Kg	1 año	Contacto

Desmontadora de llantas para rines

Tire changer
Rin de:
10" a 20"



D-1020 AA05011

EMPAQUE	PZAS.	PESO	GARANTÍA	CONEXIÓN
Caja	1	190 Kg	1 año	Contacto

Desmontadora de llantas para rines con brazo de apoyo

Tire changer
Rin de:
10" a 24"



DMK-1024 AA05014

EMPAQUE	PZAS.	PESO	GARANTÍA	CONEXIÓN
Caja	1	313 Kg	1 año	Contacto

Desmontadora de llantas para rines con 2 brazos de apoyo

Tire changer
Rin de:
12" a 28"



DDBMK-1226 AA05038

EMPAQUE	PZAS.	PESO	GARANTÍA	CONEXIÓN
Caja	1	310 Kg	1 año	Contacto

Desmontadora de llantas para camión

Truck Tire changer
Rin de:
14" a 42"



DCA-1442 AA05012

EMPAQUE	PZAS.	PESO	GARANTÍA	CONEXIÓN
Caja	1	774 Kg	1 año	Contacto

MODELO / MODEL	DM -824	D-1020	DESMK-1020	DMK-1024	DDBMK-1226	DCA-1442
Diámetro Máx. de la llanta / Max Rim Diameter Pulg	8 a 24	10 a 20	12 a 24	10 a 24	12 a 28	14 a 42
Ancho Max. del Rin / Max Rim width Pulg	10	14	16	16	16	20
Presión de trabajo / Working pressure PSI	N.A.	120	120	120	120	N.A.
Potencia Motor / Motor Power HP	N.A.	1	1	1.5	1.5	3
Especificación eléctrica / Electric Specification V/Hz	N.A.	120 / 60	120 / 60	120 / 60	120 / 60	220 / 60
Fases / Phase	N.A.	1	1	1	1	3
Jet de inflado en la mesa / Table Inflation Jet	N.A.	NO	SI	SI	SI	NO
Brazos de apoyo / Helping arms	N.A.	N.A.	N.A.	1	2	N.A.





Equipo Llantero / TIRE CHANGING EQUIPMENT

Tanque para aire comprimido

Air Tank

19 Its

Presión de salida
de aire 115 PSI
Pressure gauge
115 PSI



TAC-19 AA19017

EMPAQUE	PZAS.	PESO	GARANTÍA
Caja	1	7 Kg	1 año

Tanque para aire comprimido

Air Tank

37 Its

Presión de salida
de aire 115 PSI
Pressure gauge
115 PSI



TAC-34 AA19018

EMPAQUE	PZAS.	PESO	GARANTÍA
Caja	1	8 Kg	1 año

Tanque asentador de ceja Cheeta®

Bead setting tank

22 Its



TAC-22 AA05034

EMPAQUE	PZAS.	PESO	GARANTÍA
Caja	1	10.6 Kg	1 año

Generador de nitrógeno

Nitrogen Generator

90 Its



- 3 niveles de generación de nitrógeno:
 - 55-77 litros por minuto (pureza al 98%)
 - 110-120 litros por minuto (pureza al 95%)
 - 130-145 litros por minuto (pureza al 92%)
- Números de gran tamaño para ver con facilidad a distancia
- Pantalla LED de alta visibilidad
- Cuenta con 4 carretes para carga simultánea en las 4 llantas

Requiere un compresor de 500 litros y presión de 140 PSI.

GN-90-4 AA05039

EMPAQUE	PZAS.	PESO	GARANTÍA	CONEXIÓN
Caja Madera	1	137 Kg	1 año	Contacto

Generador de nitrógeno

Nitrogen Generator

70 Its



- Pureza del nitrógeno generado del 95% al 99%
- Tanques internos con capacidad de 70 litros (2 x 35 Its.)
- Capacidad de surtido para automóviles y camiones ligeros
- Presión de salida del nitrógeno 85 PSI a 115 PSI (6 a 8 Bar)
- Capacidad de generación de 50 a 70 litros de nitrógeno por minuto (13.2 a 18.5 Galones x minuto)

Requiere un compresor de 500 litros y presión de 140 PSI.

GN-70-1 AA05048

EMPAQUE	PZAS.	PESO	GARANTÍA	CONEXIÓN
Caja Madera	1	70 Kg	1 año	Contacto

Torno para frenos

Brake Lathe

26 Piezas

Accesorios incluidos:



Construido para durar muchos años de servicio. Cuenta con diferentes velocidades, ya sea acelerando a través de un corte inicial áspero o de una sola pasada de acabado fino. Controles ergonómicos, ofrecen comodidad de trabajo a los operario.

TF-9500 AA05037

EMPAQUE	PZAS.	PESO	GARANTÍA	CONEXIÓN
Caja	1	325 Kg	1 año	Contacto



Características:

- Diámetro máximo del disco 457 mm (18")
- Diseñado para rectificadores rápidos y finos
- Diámetro máximo del tambor 710 mm (28")
- Capacidad para alto volumen de trabajo
- Profundidad máxima del tambor 250 mm (9.875")
- Proceso de corte de una sola pasada
- Maquina la mayoría de los tambores y todo tipo de discos.
- Accesorios fácilmente intercambiables, lo cual permite que el torno sea flexible para las diferentes aplicaciones.
- Las velocidades crecientes proveen tiempos de maquinado de hasta sólo 4 minutos o más.





Gatos Hidráulicos de Botella / HYDRAULIC BOTTLE JACKS

Con tornillo extensión

With extension screw

2 t



GTE-2 BA01007

EMPAQUE	PZAS.	PESO	GARANTÍA
Caja Color	1/6	2.8 Kg	1 año

Con tornillo extensión

With extension screw

4 t



GTE-4 BA01009

EMPAQUE	PZAS.	PESO	GARANTÍA
Caja Color	1/6	3.5 Kg	1 año

Con tornillo extensión

With extension screw

6 t



GTE-6 BA01010

EMPAQUE	PZAS.	PESO	GARANTÍA
Caja Color	1/6	4.5 Kg	1 año

Con tornillo extensión

With extension screw

8 t



GTE-8 BA01012

EMPAQUE	PZAS.	PESO	GARANTÍA
Caja Color	1/4	5.8 Kg	1 año

Con tornillo extensión

With extension screw

12 t



GTE-12 BA01006

EMPAQUE	PZAS.	PESO	GARANTÍA
Caja Color	1/3	7.6 Kg	1 año

Con tornillo extensión

With extension screw

16 t



GTE-16 BA01017

EMPAQUE	PZAS.	PESO	GARANTÍA
Caja Color	1/2	8.7 Kg	1 año

Con tornillo extensión

With extension screw

20 t



GTE-20 BA01008

EMPAQUE	PZAS.	PESO	GARANTÍA
Caja Color	1/2	11 Kg	1 año

32 t



GT-32 BA01004

EMPAQUE	PZAS.	PESO	GARANTÍA
Caja Color	1/2	14 Kg	1 año

50 t



GT-50 BA01005

EMPAQUE	PZAS.	PESO	GARANTÍA
Caja Color	1	30 Kg	1 año

MODELO / MODEL	GTE-2	GTE-4	GTE-6	GTE-8	GTE-12	GTE-16	GTE-20	GT-32	GT-50
Altura Mínima Minimum Height mm	181	194	216	230	230	230	242	239	300
Recorrido Hidráulico Hydraulic Stroke mm	116	118	127	147	155	150	150	152	180
Recorrido Extensible Extension Screw mm	48	60	70	80	80	80	60	-	-
Altura Total Total height mm	345	372	413	457	465	460	452	391	480





32 t



GH-30 AA01025
EMPAQUE PZAS. PESO GARANTÍA
Caja Color 1 27 Kg 2 años

50 t



GH-50 AA01027
EMPAQUE PZAS. PESO GARANTÍA
Caja Color 1 29 Kg 2 años

Bomba de 2 velocidades

Double pump system

50 t



GHD-50 AA01029
EMPAQUE PZAS. PESO GARANTÍA
Caja Color 1 40 Kg 2 años

Bomba de 2 velocidades

Double pump system

100 t



GH-100 AA01018
EMPAQUE PZAS. PESO GARANTÍA
Caja Madera 1 90 Kg 2 años

Aceite para gato hidráulico

Hydraulic oil for Jacks

1 litro



GH-2000 AA21003
EMPAQUE PZAS. PESO GARANTÍA
Caja / Granel 6 0.91 Kg 2 años

C) Recorrido Extensible
Extension Screw

B) Recorrido Hidráulico
Hydraulic Stroke

A) Altura Mínima
Minimum Height

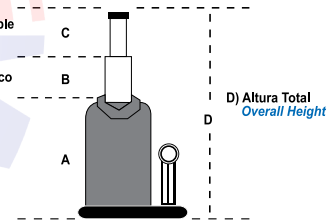

100% Reparable

Diseño totalmente desarmable que permite la sustitución de piezas gastadas o dañadas. Absoluta disponibilidad de refacciones, le aseguran que el gato le servirá por muchos años.

100% Reparable

Each jack can be completely disassembled, allowing for easy replacement of worn or damaged parts. The continuous availability of spare parts ensures reliable performance of your jack for many years to come.

MODELO / MODEL		GH-1.5	GH-3	GH-5	GH-8	GH-12	GH-20	GH-30	GH-50	GHD-50	GH-100	
Altura Mínima / Minimum Height	mm	A	180	210	217	220	220	280	285	235	260	335
Recorrido Hidráulico / Hydraulic Stroke	mm	B	115	147	153	149	140	190	180	120	150	180
Recorrido Extensible / Extension Screw	mm	C	60	68	70	96	90	---	---	---	---	---
Altura Máxima / Maximum height	mm	D	355	425	440	465	450	470	465	355	410	515





Gatos Hidráulicos Especiales / HYDRAULIC SPECIALTY JACKS

Telescópico

Telescopic
2.5 t



GET-2.5 AA01016	EMPAQUE	PZAS.	PESO	GARANTÍA
Caja Color	1	5.8 Kg	1 año	

Con tornillo extensión

With extension screw
5 t



GE-5 AA01013	EMPAQUE	PZAS.	PESO	GARANTÍA
Caja Color	1	5.37 Kg	1 año	

Con tornillo extensión

With extension screw
5.5 t



GE-5.5 AA01081	EMPAQUE	PZAS.	PESO	GARANTÍA
Caja Color	1	5.37 Kg	1 año	

Con tornillo de extensión

With extension screw
8 t



GE-8 AA01014	EMPAQUE	PZAS.	PESO	GARANTÍA
Caja Color	1	5.5 Kg	1 año	

Chaparro

12 t



GH-12CH AA01020	EMPAQUE	PZAS.	PESO	GARANTÍA
Caja Color	1	7.1 Kg	1 año	

Chaparro

20 t



GH-20CH AA01022	EMPAQUE	PZAS.	PESO	GARANTÍA
Caja Color	1	9.5 Kg	1 año	

Todos estos Gatos cuentan con la certificación



Cumplen con los requerimientos de NOM-114-scf-2006

Todos estos Gatos se desarrollan bajo especificaciones y requerimientos del cliente.

MODELO / MODEL		GET-2.5	GE-5	GE-5.5	GE-8	GH-12CH	GH-20CH
Altura Mínima / Minimum Height	mm A	236.5	228	239	255	160	167
Recorrido Hidráulico / Hydraulic Stroke	mm B	349.5	140	176	183	75.5	89
Recorrido Extensible / Extension Screw	mm C	158	71	72	65	59	N/A
Altura Total / Total height	mm D	586	439	487	503	295.5	256

A) Altura Mínima / Minimum Height

B) Recorrido Hidráulico / Hydraulic Stroke

C) Recorrido Extensible / Extension Screw

D) Altura Total / Total Height

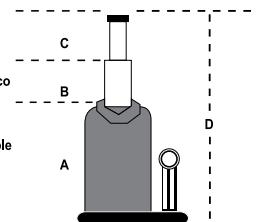



desde 1960

Gatos Hidráulicos Telescópicos de Botella / TELESCOPIC HYDRAULIC BOTTLE JACKS

1.5 t



GHT-1.5	AA01035		
EMPAQUE	PZAS.	PESO	GARANTÍA
Caja Color	6	3.6 Kg	2 años

2.5 t



GHT-2.5	AA01038		
EMPAQUE	PZAS.	PESO	GARANTÍA
Caja Color	3	5.2 Kg	2 años

12 t



GHT-12	AA01037		
EMPAQUE	PZAS.	PESO	GARANTÍA
Caja Color	1	9.34 Kg	2 años

MODELO / MODEL		GHT-1.5	GHT-2.5	GHT-12
Altura Mínima / Minimum Height	mm	179.7	201.5	154
Recorrido Hidráulico / Hydraulic Stroke	mm	223	114	89
Recorrido Extensible / Extension Screw	mm	113	129	87
Altura Máxima / Maximum height	mm	403	445	330



Gatos de Tijera / SCISSOR JACKS

800 kg

Altura mínima: 8 cm
Minimum Height
Altura máxima: 31 cm
Maximum Height
Recorrido extensible: 23 cm Stroke



GMT-800	AA02038		
EMPAQUE	PZAS.	PESO	GARANTÍA
Caja Color	4	1.7 Kg	1 año

1 t

Altura mínima: 9,5 cm
Minimum Height
Altura máxima: 40 cm
Maximum Height
Recorrido extensible: 30 cm Stroke



GMT-1	AA02037		
EMPAQUE	PZAS.	PESO	GARANTÍA
Caja Color	4	2.6 Kg	1 año

Gato de Cremallera / Farm Jack

3 t

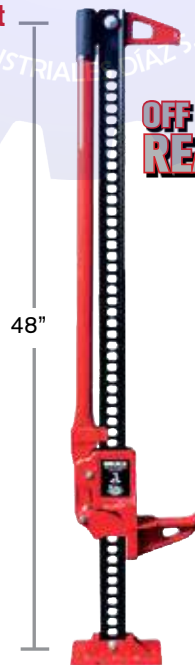

48"

OFF ROAD READY

GC-7000	AF17026		
EMPAQUE	PZAS.	PESO	GARANTÍA
Caja Color	1	13.2 kg	2 años

Winch Eléctrico / Electric Winch

10000 Lbs
4536 Kg
12 Vcd

NEW!

¡Ideal para vehículos
4x4
TODO TERRENO



Cable de acero REFORZADO
Para mayor resistencia

26 m
Longitud del cable

WE-10	AA02131		
EMPAQUE	PZAS.	PESO	GARANTÍA
olor	1	44 kg	2 años





Gatos Hidroneumáticos / HYDROPNEUMATIC JACKS

Tipo botella c/ tornillo extensión

Bottle with extension screw

12 t

Con tornillo extensión, reduce el tiempo de levante, cuenta con resortes de retorno



GN-12 AA016005	EMPAQUE	PZAS.	PESO	GARANTÍA
Caja Color	1	12.2 Kg	1 año	

Tipo botella c/ tornillo extensión

Bottle with extension screw

20 t

Con tornillo extensión, reduce el tiempo de levante, cuenta con resortes de retorno



GN-20 AA016006	EMPAQUE	PZAS.	PESO	GARANTÍA
Caja Color	1	16.5 Kg	1 año	

Tipo botella

Bottle

35 t

Bomba neumática de gran eficiencia, resortes de retorno para mejor desempeño.



GN-35 AA016007	EMPAQUE	PZAS.	PESO	GARANTÍA
Caja Color	1	21.4 Kg	1 año	

Tipo botella de baja altura

Low profile bottle type

20 t

Sistema de operación DUAL manual y neumático de rápido accionamiento



GN-20CH AA16017	EMPAQUE	PZAS.	PESO	GARANTÍA
Caja	1	15.4 Kg	1 año	

Tipo botella con carrito

Bottle with cart

20 t

Manguera flexible reforzada, resiste hasta 15,000 psi. Empaques de nitrilo bruno N, resisten temperaturas de -20 °F a +225 °F. Reinforced 15,000 psi, hose. Nitrile buna N seals resist from -20 °F + 225 °F.



GHC-20T AA16004	EMPAQUE	PZAS.	PESO	GARANTÍA
Caja	1	21.7 Kg	1 año	

Patín

Garage

5 t

Ruedas traseras giratorias de fundición, estructura de acero de uso rudo Heavy duty cast iron casters



GA-206 AA16001	EMPAQUE	PZAS.	PESO	GARANTÍA
Caja	1	116 Kg	1 año	

Patín

Garage

10 t

Servicio pesado, base y cilindros soldados para reforzar la base y eliminar fugas

Heavy duty welded base to prevent leaks



GA-210 AA16002	EMPAQUE	PZAS.	PESO	GARANTÍA
Caja	1	171 Kg	1 año	

Uso profesional equipo pesado

Professional, heavy duty use

22 t

NOTA: La operación es neumática
The operation is only pneumatic



GA-322 AA16003	EMPAQUE	PZAS.	PESO	GARANTÍA
Caja	1	38.5 Kg	1 año	

35 t

NOTA: La operación es neumática
The operation is only pneumatic



GA-335 AA16015	EMPAQUE	PZAS.	PESO	GARANTÍA
Caja	1	49 Kg	1 año	

MODELO / MODEL	GN-12	GN-20	GN-20CH	GN-20CH	GHC-20T	GA-206	GA-210	GA-322	GA-335
Altura Mínima / Minimum Height	mm 265	265	210	265	253	150	160	220	260
Recorrido Hidráulico / Hydraulic Stroke	mm 165	165	102	150	160	410	400	110	115
Recorrido Extensible / Extension Screw	mm 80	80	80	---	70	---	---	95	135
Altura Total / Total height	mm 510	510	393	415	483	560	560	425	510
Presión de Aire / Air Pressure	90-120 Psi	90-120 Psi	90-120 Psi	90-120 Psi	90-120 Psi	90-120 Psi	90-120 Psi	90-120 Psi	90-120 Psi





Gatos Hidráulicos de Patín / HYDRAULIC FLOOR JACKS

Aluminio Extra Bajo

Aluminum quick lifting

1.5 t



GAEL-3 AA01011

EMPAQUE	PZAS.	PESO	GARANTÍA
Caja Color	1	12.5 Kg	6 meses

Compacto

Compact

2 t



Con Portafolio

GP2C AA01040

EMPAQUE	PZAS.	PESO	GARANTÍA
Portafolio	1	10.9 Kg	6 meses

Compacto para SUV, Pick Ups

Compact for SUV'S & Pick Up Trucks

2 t



GPC-T2 AA01045

EMPAQUE	PZAS.	PESO	GARANTÍA
Caja Color	1	11.4 Kg	6 meses

Premier

2 t



Con Portafolio

GP2T AA01042

EMPAQUE	PZAS.	PESO	GARANTÍA
Portafolio	1	10.4 Kg	6 meses

Estructura de una sola pieza extra, válvula de seguridad para evitar la sobrecarga.

Racing

2 t

Diseño de manija exclusivo en el mercado, para transportarlo en forma vertical



GP-2M AA01041

EMPAQUE	PZAS.	PESO	GARANTÍA
Caja Color	1	9.2 Kg	6 meses

Ruedas traseras giratorias con 360° de movimiento.

Racing con portafolio

2 t

Diseño de manija exclusivo en el mercado, para transportarlo en forma vertical



Con Portafolio

GPP-2M AA01051

EMPAQUE	PZAS.	PESO	GARANTÍA
Portafolio	1	9.9 Kg	6 meses

Ruedas traseras giratorias con 360° de movimiento.

2 t



TIMER

GP2 BA01002

EMPAQUE	PZAS.	PESO	GARANTÍA
Caja Color	1	9 Kg	6 meses

2 t



TIMER

GPP2 AA01042

EMPAQUE	PZAS.	PESO	GARANTÍA
Portafolio	1	9.85 Kg	6 meses

Con Portafolio





Gatos Hidráulicos de Patín / HYDRAULIC FLOOR JACKS

Ultra bajo

Ultra low profile

2 t



Doble sistema de Bombeo Dual pump

GPUB-2 AA01085

EMPAQUE	PZAS.	PESO	GARANTÍA
Caja Color	1	45 Kg	1 año

Premier

2.5 t



Con Portafolio

GP25T AA01039

EMPAQUE	PZAS.	PESO	GARANTÍA
Portafolio	1	12 Kg	6 meses

Premier Extrabajo

Extra-low profile

2.5 t



GPFB-25 AA01046

EMPAQUE	PZAS.	PESO	GARANTÍA
Caja Color	1	14.5 Kg	6 meses

Para SUV's, Pick Ups

For SUV'S & Pick Up Trucks

2.5 t



Brazo largo

GPSUV-2.5 AA01052

EMPAQUE	PZAS.	PESO	GARANTÍA
Caja Color	1	23.2 Kg	6 meses

Premier para SUV's, Pick Ups con tornillo de extensión

For SUV'S & Pick Up Trucks with extension screw

3 t



GPP-03 AA01050

EMPAQUE	PZAS.	PESO	GARANTÍA
Caja Color	1	16.7 Kg	6 meses

Duty para taller

Workshop duty

3 t



Doble sistema de Bombeo Dual Pump

GP-3M AA01043

EMPAQUE	PZAS.	PESO	GARANTÍA
Caja Color	1	33.7 Kg	1 año

Trabajo Pesado

Heavy Duty

3 t



Doble sistema de Bombeo Dual Pump

G-489 AA01010

EMPAQUE	PZAS.	PESO	GARANTÍA
Caja Color	1	33.6 Kg	1 año

Estructura extra resistente, válvula de seguridad para evitar la sobrecarga

Reforzado

Reinforced

3 t



TOMER

GHP-3T BA01001

EMPAQUE	PZAS.	PESO	GARANTÍA
Caja Color	1	34 Kg	6 meses





Gatos Hidráulicos de Patín / HYDRAULIC FLOOR JACKS

desde 1960

Extra bajo levante rápido

Low profile, quick lifting

3 t

Doble sistema
de Bombeo
Dual Pump



GXL-3 AA01057

EMPAQUE	PZAS.	PESO	GARANTÍA
Caja Color	1	47 Kg	1 año

Levante rápido

Quick lifting

3.5 t



GPLR-3.5 AA01049

EMPAQUE	PZAS.	PESO	GARANTÍA
Caja Color	1	40.5 Kg	1 año

Extra bajo

Quick lifting

4 t

Doble sistema
de bombeo
Dual Pump



GHPL-4T AA01034

EMPAQUE	PZAS.	PESO	GARANTÍA
Caja Color	1	46 Kg	1 año

Levante rápido

Quick lifting

5 t

Doble sistema
de bombeo
Dual Pump



GPLR-5T AA01086

EMPAQUE	PZAS.	PESO	GARANTÍA
Caja Color	1	48 Kg	1 año

MODELO / MODEL		GAEI-3	GP-2 GPP-2	GP-2M GPP-2M	GP2C	GP2T	GPC-T2	GPUB-2	GP25T	GPEB-25	GPSUV-25
Altura Mínima / Minimum Height	mm	80	128	128	140	130	190	70	135	85	150
Recorrido de Elevación / Hydraulic Stroke	mm	295	215	215	247	203	258	530	215	296	380
Altura Máxima / Maximum height	mm	375	343	343	387	330	448	600	350	381	530
Capacidad / Capacity	t	1.5	2	2	2	2	2	2	2.5	2.5	2.5

MODELO / MODEL		GPP-03	GP-3M	G-489	GXL-3	GHP-3T	GPLR-3.5	GHPL-4T	GPLR-5T
Altura Mínima / Minimum Height	mm	190	135	133	90	135	145	70	90
Recorrido de Elevación / Hydraulic Stroke	mm	178	365	332	460	365	335	438	460
Altura Máxima / Maximum height	mm	368	500	465	550	500	500	508	550
Capacidad / Capacity	t	3	3	3	3	3	3.5	4	5





Gatos Hidráulicos de Patín Trabajo Pesado / HEAVY DUTY

Brazo extra largo

Extra Long arm

2 t

Levanta hasta 80 cm. de altura.
Lift up to 80 cm. High



G-482 AA01007

EMPAQUE	PZAS.	PESO	GARANTÍA
Caja Madera	1	65 Kg	1 año

Trabajo Extra Pesado

Extra Heavy Duty

3 t

Estructura de acero reforzada,
ideal para vehículos pesados.



G-483 AA01008

EMPAQUE	PZAS.	PESO	GARANTÍA
Caja Madera	1	90 Kg	1 año

Trabajo Extra Pesado

Extra Heavy Duty

5 t



G-485 AA01009

EMPAQUE	PZAS.	PESO	GARANTÍA
Caja Madera	1	115 Kg	1 año

Trabajo Extra Pesado

Extra Heavy Duty

10 t



G-410 AA01005

EMPAQUE	PZAS.	PESO	GARANTÍA
Caja Madera	1	165 Kg	1 año

Trabajo Extra Pesado

Extra Heavy Duty

20 t



G-420 AA01006

EMPAQUE	PZAS.	PESO	GARANTÍA
Caja Madera	1	230 Kg	1 año

Los modelos G-482, G-483, G-485, G-410 y G-420 cuentan con pedal de aproximación y palanca de carga.

Los platos giratorios están hechos de placa de acero o de fundición según su capacidad.

Steel or cast-iron rotary plates, depending on the capacity.



MODELO / MODEL			G-482	G-483	G-485	G-410	G-420
Altura Mínima / Minimum Height	mm	A	140	130	150	160	185
Recorrido de Elevación / Hydraulic Stroke	mm	B	670	490	420	370	435
Altura Máxima / Maximum height	mm	C	800	600	560	685	620
Dimensiones del gato / Jack Dimensions	cm	D	119 x 45 x 19	130 x 32 x 20	142 x 37 x 20	156 x 49 x 25	185 x 41 x 20

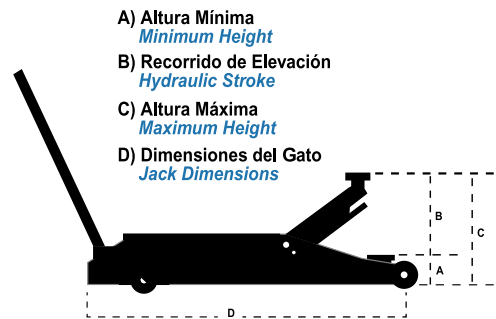



desde 1960

Gatos para Transmisiones / TRANSMISSION JACKS

Adaptador para transmisiones para gatos de patín

Transmission adaptor

500 kg



AT-500 AA08001

- Inclinación de silleta: Frente 60° - Atrás 10°
- Rango de longitud de trabajo: 10 cm - 39.3 cm
- Rango de ancho de trabajo: 22.2 cm - 33 cm

EMPAQUE	PZAS.	PESO	GARANTÍA
Caja	1	10.6 Kg	1 año

Para fosas

For pits

500 kg

- Altura Mínima: 113.5 cm
- Altura Máxima: 194 cm
- Charola: 42 X 37 cm
- Minimum Height 113.5 cm
- Maximum Height: 194 cm
- Tray: 42 X 37 cm

GTF-500 AA01055

EMPAQUE	PZAS.	PESO	GARANTÍA
Caja	1	34 Kg	1 año



Telescópico para fosas

Telescopic for workshop pits

500 kg

- Altura Mínima: 83 cm
- Altura Máxima: 180 cm
- Charola: 42 X 37 cm
- Minimum Height 83 cm
- Maximum Height: 180 cm
- Tray: 42 X 37 cm

GT-500 AA01054

EMPAQUE	PZAS.	PESO	GARANTÍA
Caja	1	57 Kg	1 año



Telescópico para fosas

Telescopic for workshop pits

1 t

- Altura Mínima: 83 cm
- Altura Máxima: 180 cm
- Charola: 35 X 25 cm
- Minimum Height 83 cm
- Maximum Height: 180 cm
- Tray: 35 X 25 cm

GT-1000 AA01053

EMPAQUE	PZAS.	PESO	GARANTÍA
Caja	1	86 Kg	1 año



500 kg

- Altura Mínima: 170 mm
- Altura Máxima: 680 mm
- Charola: 32 X 20 mm
- Minimum Height 170 mm
- Maximum Height: 680 mm
- Tray: 32 X 20 mm

Estructura reforzada para uso rudo

T-1450 AA01072

EMPAQUE	PZAS.	PESO	GARANTÍA
Caja	1	67 Kg	1 año



1 t

- Altura Mínima: 230 mm
- Altura Máxima: 760 mm
- Charola: 42 X 37 mm
- Minimum Height 230 mm
- Maximum Height: 760 mm
- Tray: 42 X 37 mm

Ruedas giratorias de fundición

T-4200 AA01076

EMPAQUE	PZAS.	PESO	GARANTÍA
Caja	1	78 Kg	1 año



1.5 t

- Altura Mínima: 165 mm
- Altura Máxima: 890 mm
- Charola: 46 X 37 mm
- Minimum Height 165 mm
- Maximum Height: 890 mm
- Tray: 46 X 37 mm

T-4215 AA01077

EMPAQUE	PZAS.	PESO	GARANTÍA
Caja	1	140 Kg	1 año



2 t

- Altura Mínima: 165 mm
- Altura Máxima: 890 mm
- Charola: 46 X 37 mm
- Minimum Height 165 mm
- Maximum Height: 890 mm
- Tray: 46 X 37 mm

T-4220 AA01080

EMPAQUE	PZAS.	PESO	GARANTÍA
Caja	1	153 Kg	1 año





Gatos Hidráulicos para Pluma / HYDRAULIC HOIST JACKS

1.5 t



GHP-1.5 AA01030

EMPAQUE	PZAS.	PESO	GARANTÍA
Granel	1	5.2 Kg	1 año

5 t



GHP-5 AA01031

EMPAQUE	PZAS.	PESO	GARANTÍA
Granel	1	10 Kg	1 año

8 t



GHP-8 AA01032

EMPAQUE	PZAS.	PESO	GARANTÍA
Granel	1	10.7 Kg	1 año

12 t



GHP-12 AA01033

EMPAQUE	PZAS.	PESO	GARANTÍA
Granel	1	17 Kg	1 año

Nivelador de Carga / LOAD LEVELER

750 kg

USO



◀ 2 cadenas de 28 cm. de largo ▶

NC-750 AA08033

EMPAQUE	PZAS.	PESO	GARANTÍA
Caja	1	5 Kg	1 año

MODELO / MODEL		GHP-1.5t	GHP-5	GHP-8	GHP-12
Altura Mínima / Minimum Height	mm	610	550	612	630
Recorrido Hidráulico / Hydraulic Stroke	mm	490	474	490	490
Altura Total / Total height	mm	1100	1024	1102	1120

Kits de Afinación Automotriz / MOTOR TUNNING KITS

Básico de Afinación Líquido Presurizado

Injectors cleaning

Incluye:

- Manómetro para la presión del combustible
- Juego de 4 conectores
- Juego de 4 desconectores
- 2 Ahorcadores
- Cadena con soporte para lata
- Manómetro con regulador



KBP AA08020

EMPAQUE	PZAS.	PESO	GARANTÍA
Estuche	1	1.6 Kg	6 meses

Boya para limpieza de inyectores

Injectors cleaning Kit

Incluye:

- Boya presurizadora
- Manguera para Boya
- Manómetro para la presión del combustible
- Tapón para modelos FORD
- Conector en "T" para modelos Nissan
- Conector en "T" TBI
- Juego de 8 desconectores
- Juego de 4 conectores
- Tarraja para válvula
- Ahorcadores
- Caja Plástica de 16"



KAA-24 AA08019

EMPAQUE	PZAS.	PESO	GARANTÍA
Caja Plástica	1/4	3.7 Kg	6 meses

Llaves para Filtro de Aceite / OIL FILTER WRENCH

2 11/16" - 3 1/2"
(68 - 90 mm)



LLFA-1 AA14011

EMPAQUE	PZAS.	PESO	GARANTÍA
Blisters	12/48	0.25 Kg	1 año

3/18" - 3 15/16"
(79 - 100 mm)



LLFA-2 AA14012

EMPAQUE	PZAS.	PESO	GARANTÍA
Blisters	12/48	0.35 Kg	1 año





desde 1960

Herramienta Especializada / SPECIALITY TOOLS

Compresómetro motores a gasolina

Petrol engine compression tester



CMG AA08036

EMPAQUE	PZAS.	PESO	GARANTÍA
Portafolio	1/16	0.7 Kg	1 año

Compresómetro diesel con accesorios

Cylinder pressure meter for diesel truck



KCD AA08037

EMPAQUE	PZAS.	PESO	GARANTÍA
Portafolio	1/5	3.4 Kg	1 año

Kit compresómetro-presión de bomba de gasolina

Compression and pressure test gauges kit



KCBG AA08038

EMPAQUE	PZAS.	PESO	GARANTÍA
Portafolio	1/20	1 Kg	1 año

Kit purga de frenos convencionales y ABS

Vacuum tester and brake bleeding kit



KPF AA08035

EMPAQUE	PZAS.	PESO	GARANTÍA
Portafolio	1/10	1.2 Kg	1 año

Kit de herramientas de sincronización NISSAN-RENAULT 1.6 l

Band synchronization kit



KH-NR16 AA08032

EMPAQUE	PZAS.	PESO	GARANTÍA
Portafolio	1	2.4 Kg	1 año

Kit de herramientas especiales para inmovilizar el árbol de levas para realizar el cambio de bandas y poleas.

Kit dado para sensor de oxígeno y aceite

Oxygen sensor and oil cap extraction kit

7 Piezas



KDSOA-7 AA08047

EMPAQUE	PZAS.	PESO	GARANTÍA
Portafolio	1	2 Kg	2 años

Juego de desconectores para líneas de combustible y aire acondicionado

Pipe connector removing kit

22 Piezas



JDLC-22 AD08040

EMPAQUE	PZAS.	PESO	GARANTÍA
Portafolio	1/10	1 Kg	1 año

Opresor calibrador de discos para frenos

Universal caliper wind back kit

18 Piezas



CDT-18 AD08041

EMPAQUE	PZAS.	PESO	GARANTÍA
Portafolio	1/10	2.5 Kg	1 año





Herramienta Especializada / SPECIALITY TOOLS

Kit extractor para bujías rotas

Internal & external puller set

5 Piezas



KEIE-5 AD08043

EMPAQUE	PZAS.	PESO	GARANTÍA
Portafolio	1/3	4.9 Kg	1 año

Kit extractor de rodamientos

Bearing separator assembly kit

15 Piezas



KER-15 AD08044

EMPAQUE	PZAS.	PESO	GARANTÍA
Portafolio	1/3	5.4 Kg	1 año

Kit extractor para bujías rotas

Spark plug thread repair kit

27 Pzas



EXBR-6 AD08042

EMPAQUE	PZAS.	PESO	GARANTÍA
Portafolio	1/20	1.4 Kg	1 año

Juego de herramienta automotriz

Socket sets

171 Pzas



JHA-171 AE14188

EMPAQUE	PZAS.	PESO	GARANTÍA
Portafolio	2	7.7 Kg	2 años

Juego especial de puntas torx spline

Star socket & bits socket set

34 Piezas



JEPTS-34 AE14189

EMPAQUE	PZAS.	PESO	GARANTÍA
Portafolio	12	1.13 Kg	2 años

Juego de puntas torx para transmisión automática

DR Torx bits socket set

32 Piezas



PTTA-32 AE14190

EMPAQUE	PZAS.	PESO	GARANTÍA
Portafolio	4	5 Kg	2 años

Juego de puntas torx para ajuste de motor

Set tools for car engine

38 Piezas



PTAM-38 AE14191

EMPAQUE	PZAS.	PESO	GARANTÍA
Portafolio	4	5.1 Kg	2 años

Kit detector de fugas del sistema de enfriamiento automotriz

Radiator pressure tester vacuum type-cooling system kit



KDFA-17 AA08049

EMPAQUE	PZAS.	PESO	GARANTÍA
Portafolio	1	15 Kg	6 meses





desde 1960

Herramienta Especializada / SPECIALITY TOOLS

Kit probador de pulsos en inyectores

Electronic fuel injection and signal noid lite tester

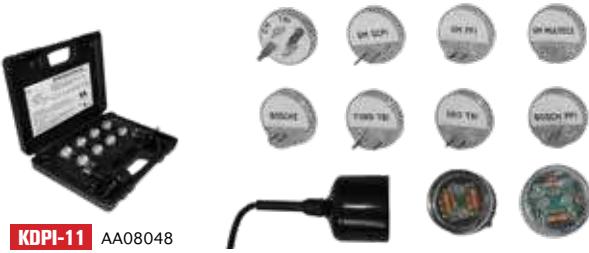

K DPI-11 AA08048

EMPAQUE	PZAS.	PESO	GARANTÍA
Portafolio	1	0.8 Kg	6 meses

Extractor de polea damper GM

Harmonic damper pulley set

6 Piezas



EPDGM-5 AA08058

EMPAQUE	PZAS.	PESO	GARANTÍA
Portafolio	1/4	1 Kg	1 año

Juego de dados y puntas para alternador 18 pzas

Alternator tool set

6 Piezas



JDPA-18 AA08060

EMPAQUE	PZAS.	PESO	GARANTÍA
Portafolio	1/10	1.5 Kg	1 año

Juego instalador de baleros y sellos

Harmonic damper pulley set

10 Piezas



JIBS-10 AA08053

EMPAQUE	PZAS.	PESO	GARANTÍA
Portafolio	1	3.9 Kg	1 año

Kit para montar/desmontar rótulas y terminales

Ball joint mounting & Demounting tool kit

7 Piezas



KMDR-7 AA08054

EMPAQUE	PZAS.	PESO	GARANTÍA
Portafolio	1/3	5 Kg	1 año

Set de dados hexagonales para drenar aceite

Quadrilateral and hex oil drainer

12 Piezas



SDHDA-12 AA08065

EMPAQUE	PZAS.	PESO	GARANTÍA
Portafolio	1/10	1.15 Kg	1 año

Kit para sincronizar bandas de distribución Ford

Engine setting locking kit

9 Piezas



KBDF-5 AA08062

EMPAQUE	PZAS.	PESO	GARANTÍA
Portafolio	1/4	0.5 Kg	1 año

Set de arco levanta válvulas

Valve spring compressor set

9 Piezas



SALV-7 AA08055

EMPAQUE	PZAS.	PESO	GARANTÍA
Portafolio	1/3	1.5 Kg	1 año





Herramienta Especializada / SPECIALITY TOOLS

Set para colocar y remover abrazaderas

Hose clamp pliers set

10 Piezas



SCRA-7 AA08059

EMPAQUE	PZAS.	PESO	GARANTÍA
Portafolio	1/2	3.75 Kg	1 año

Kit de cambio de banda spark GM1.0

Spark GM 1.0 transmission band changing set

7 Piezas



SCBS-5 AA08067

EMPAQUE	PZAS.	PESO	GARANTÍA
Portafolio	1/10	1 Kg	1 año

NEW!

Kit de cambio de banda Vento 1.8

Vento 1.8 transmission band changing set

7 Piezas



SCBV-4 AA08068

EMPAQUE	PZAS.	PESO	GARANTÍA
Portafolio	1/20	1.5 Kg	1 año

Kit de cambio de banda VW Bora

VW bora transmission band changing set

7 Piezas



SCBB-5 AA08066

EMPAQUE	PZAS.	PESO	GARANTÍA
Portafolio	1/10	1.2 Kg	1 año

NEW!

Set de llaves combinadas con matraca cabeza flexible

Flexible head ratchet type combined wrench set

7 Piezas

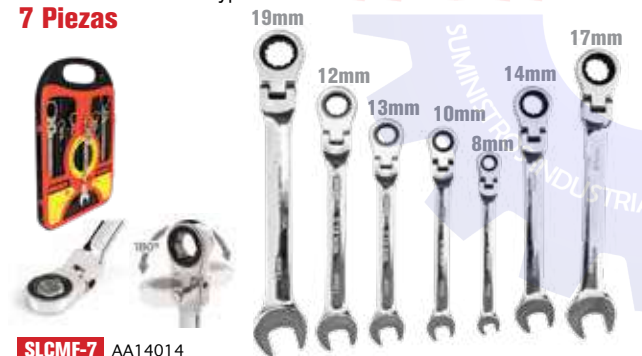

SLCMF-7 AA14014

EMPAQUE	PZAS.	PESO	GARANTÍA
Estuche	1/20	1.2 Kg	1 año

Cromo vanadio acabado espejo
Chrome vanadium mirror finish

Set de llaves combinadas con matraca

Ratchet type combined wrench set

5 Piezas



SLCM-5 AE14199

EMPAQUE	PZAS.	PESO	GARANTÍA
Estuche	1/20	1.2 Kg	1 año

Cromo vanadio acabado espejo
Chrome vanadium mirror finish

NEW!

Set de llaves combinadas con matraca

Ratchet type combined wrench set

7 Piezas



SLCM-7 AA14013

EMPAQUE	PZAS.	PESO	GARANTÍA
Estuche	1/20	1.2 Kg	1 año

Cromo vanadio acabado espejo
Chrome vanadium mirror finish

Desarmador de impacto

Impact screwdriver

14 Piezas



DIMP-14 AE14192

EMPAQUE	PZAS.	PESO	GARANTÍA
Estuche	1/16	0.65 Kg	1 año

Puntas Cr-V
Bits Cr-V





desde 1960

Herramienta Especializada / SPECIALITY TOOLS

Juego para sincronizar bandas de distribución

Engine timing tool kit

7 Piezas



KDSA-7 AD08056

EMPAQUE	PZAS.	PESO	GARANTÍA
Portafolio	1/10	0.68 Kg	1 año

Opresor de resortes para suspensión MCPHERSON®

Mcpheerson strut spring opressor

18 Piezas



CRSM-2 AD08057

EMPAQUE	PZAS.	PESO	GARANTÍA
Portafolio	4	4 Kg	1 año

Probador de chispa automotriz para bujía

Spark plug tester



PCA AA08050

EMPAQUE	PZAS.	PESO	GARANTÍA
Blister	144	0.12	6 meses

Torquímetro de trueno

Click Stop Torque Wrench



Estuche

Torque 28-210 N.m (22-154 Pie/Lb)

NEW!



TT-28210 AA08072

EMPAQUE	PZAS.	PESO	GARANTÍA
Estuche	1/10	2.1 Kg	6 meses

•Mando: 1/2" •Mango moleteado •24 dientes por matraca •Fabricado en Cromo Vanadio

Intercambiador de aceite de transmisión automática

Oil and Fluid Exchanger

- REMUEVE
 - LIMPIA
 - REEMPLAZA
- 2 TANQUES** con capacidad de 30 L

Uso para todo el Parque Vehicular a Gasolina y Diesel

Temperatura máxima de operación **80°C**



IAAT-322 AA08052

EMPAQUE	PZAS.	PESO	GARANTÍA
Caja Color	2	72.2 Kg	1 año

Inflador automático de llantas

Automatic Tire Inflator

90 PSI

- Pantalla LED
- Hasta 100PSI
- Voltaje 120Vca
- Flujo de aire 400L/min



IFL-90 AA08053

EMPAQUE	PZAS.	PESO	GARANTÍA
Caja Color	1	3.5 Kg	1 año

Termómetro Infrarojo

Infrared thermometer

-38 °C a 520 °C

Requiere 2 baterías AA
Cuenta con apuntador con laser



TI-38520 AD22001

EMPAQUE	PZAS.	PESO	GARANTÍA
Blister	10/20	0.2 Kg	1 año

Laboratorio de inyectores

Auto fuel injector tester & cleaner

6 Inyectores

110 Vca

- Limpieza con ultrasonido
- Prueba de vacío (0 - 20 ms)
- Velocidad media (0-4 ms)
- Prueba de aceleración
- Prueba de desplazamiento
- Prueba de goteo
- Prueba de spray en vacío
- Prueba de spray velocidad media
- Prueba de spray velocidad alta
- Flujo en reversa
- Prueba sin desarmar

Uso para todo el Parque Vehicular a Gasolina



LIV-6 AA08045

EMPAQUE	PZAS.	PESO	GARANTÍA	CONEXIÓN
Caja Corrugado	1	30 Kg	1 año	Contacto

Equipo de recuperación y reciclaje de aire acondicionado

A/C recovery and recharge machine

254 PSI

- Velocidad de **RECICLAJE:** 180-350 L/min
- Velocidad de **CARGA:** 800-1 500 L/min
- Flujo de **VACÍO:** 60 L/min



ERRA AA08046

EMPAQUE	PZAS.	PESO	GARANTÍA	CONEXIÓN
Caja Color	1	83 Kg	1 año	Contacto





Herramienta Especializada / SPECIALITY TOOLS

Juego de llaves de Obstrucción "U"

Air Orbit Sander

5 PZS

NEW!



JLO-5 AA08071

EMPAQUE	PZAS.	PESO	GARANTÍA
Blister	1/20	1.2 Kg	1 año

Juego de llaves de Obstrucción "S"

Air Orbit Sander

5 PZS

NEW!



JLS-5 AA08073

EMPAQUE	PZAS.	PESO	GARANTÍA
Blister	1/20	1.2 Kg	1 año

Herramienta Neumática / PNEUMATIC TOOLS

Lijadora orbital

Air Orbit Sander

5"

2.5 CFM



LON-5 AA23004

EMPAQUE	PZAS.	PESO	GARANTÍA
Caja Color	1/20	1.19Kg	6 meses

Esmeriladora

Angle grinder

4 1/2"

4 CFM



Guarda de Seguridad de ajuste rápido

EA-45 AA23003

EMPAQUE	PZAS.	PESO	GARANTÍA
Caja Color	10	2.1 Kg	1 año

Pulidora Neumática

Polisher

7"

6 CFM



PN-7 AA23018

EMPAQUE	PZAS.	PESO	GARANTÍA
Caja Color	2	3.34 Kg	1 año

Matracas de impacto

Impact Ratchet

1/2"

3 CFM

Torque: 50 lb/ft



Válvula de reversa para cambios de dirección
Reverse valve for direction change

MIN-12 AA23005

EMPAQUE	PZAS.	PESO	GARANTÍA
Caja Color	5	1.3 Kg	1 año

Matracas de impacto

Impact Ratchet

3/8"

3 CFM

Torque: 50 lb/ft



Válvula de reversa para cambios de dirección
Reverse valve for direction change

MIN-38 AA23006

EMPAQUE	PZAS.	PESO	GARANTÍA
Caja Color	5	1.31 Kg	1 año

Mototool

Mototool

1/4"

2.5 CFM

2,500 RPM's



Consumo de aire 84 Lts./min. (3CFM)

MTN-14 AA23020

EMPAQUE	PZAS.	PESO	GARANTÍA
Caja Color	30	0.5 Kg	6 meses

Sierra cortadora

Air Body Saw

1/4"

3 CFM



- Velocidad: 9000 RPM
- Capacidad de corte:
Aluminio 1.5 mm
Acero 1.3 mm
- Consumo de aire:
184 l/min (6.5 cfm)

SCN-1/4 AA23019

EMPAQUE	PZAS.	PESO	GARANTÍA
Caja Color	1/20	0.7 Kg	6 meses

Filtro regulador y lubricador

Maintenance unit

3/8"



FRL-3000 AA23022

EMPAQUE	PZAS.	PESO	GARANTÍA
Caja Color	1/12	0.7 Kg	1 año

Filtro regulador y lubricador

Maintenance unit

1/2"



FRL-4000 AA23021

EMPAQUE	PZAS.	PESO	GARANTÍA
Caja Color	1/6	1.5 Kg	1 año



Herramienta Neumática / PNEUMATIC TOOLS

Cizalla neumática

Pneumatic Metal Shear
4 CFM



CIN AA23001

EMPAQUE	PZAS.	PESO	GARANTÍA
Caja Color	1/10	1.4 Kg	6 meses

Cortadora de Disco

Cut-Off Tool
3"
4 CFM



CN-3 AA23002

EMPAQUE	PZAS.	PESO	GARANTÍA
Caja Color	1/20	0.87 Kg	6 meses

Pistola de impacto

Wrench
1/2"
4 CFM

Sistema "Single Hammer"
Torque: 320 lb/ft



Control de velocidad que permite hacer que la pistola gire a distintas velocidades

PIN-1/2 AA23008

EMPAQUE	PZAS.	PESO	GARANTÍA
Caja Color	1/4	2.3 Kg	6 meses

Pistola de impacto

Wrench
1/2"
6 CFM

Sistema "Twin Hammer"
Torque Variable
Máximo: 600 lb/ft



- Entrada de aire de 1/4"
- Sistema de dos martillos(Twin Hammer)
- Potencia 7000 rpm

PIN-600 AA23011

EMPAQUE	PZAS.	PESO	GARANTÍA
Caja Color	1/10	2.6 Kg	1 año

Pistola de impacto

Wrench
1/2"
6 CFM

Sistema "Twin Hammer"
Torque Variable
Máximo: 529 lb/ft



PIN-734 AA23013

EMPAQUE	PZAS.	PESO	GARANTÍA
Caja Color	1/8	2.8 Kg	1 año

Pistola de impacto vástago largo

Wrench
1/2"
6 CFM

Sistema "Twin Hammer"
Torque Variable
Máximo: 500 lb/ft



PIN-677L AA23012

EMPAQUE	PZAS.	PESO	GARANTÍA
Caja Color	1/8	3 Kg	1 año



Herramienta Neumática / PNEUMATIC TOOLS

Pistola de impacto industrial

Industrial wrench

1/2"

6 CFM

Sistema "Twin Hammer"
Torque Variable
Máximo: 625 lb/ft



PIN-850 AA23015

EMPAQUE	PZAS.	PESO	GARANTÍA
Caja Color	1/8	3 Kg	1 año

Pistola de impacto

Wrench

3/4"

6 CFM

Sistema "Twin Hammer"
Torque Variable
Máximo: 729 lb/ft



PIN-3/4 AA23010

EMPAQUE	PZAS.	PESO	GARANTÍA
Caja Color	1/8	5 Kg	1 año

Pistola de impacto con kit 10 dados

Wrench with 10 Sockets Kit

1/2"

4 CFM

Sistema "single hammer"
Torque: 320 lb/ft



- 1 barra de extensión
- 1 mini lubricador
- 1 conector neumático
- 10 dados milimétricos: 9 mm, 10 mm, 11 mm, 13 mm, 14 mm, 17 mm, 19 mm, 22 mm, 24 mm, 27 mm
- 1 extension bar
- 1 mini oiler
- 1 pneumatic quick connector
- 10 Metric sockets: 9 mm, 10 mm, 11 mm, 13 mm, 14 mm, 17 mm, 19 mm, 22 mm, 24 mm, 27 mm

PINK-1/2 AA23016

EMPAQUE	PZAS.	PESO	GARANTÍA
Portafolio	1/4	4.2 Kg	1 año

Pistola de impacto con kit 10 dados

Wrench with 10 Sockets Kit

1/2"

6 CFM

Sistema "twin hammer"
Torque: 529 lb/ft



- 1 barra de extensión
- 1 mini lubricador
- 1 conector neumático
- 8 dados milimétricos: 10 mm, 11 mm, 13 mm, 14 mm, 17 mm, 19 mm, 22 mm, 24 mm
- 1 extension bar
- 1 mini oiler
- 1 pneumatic quick connector
- 8 Metric sockets: 10 mm, 11 mm, 13 mm, 14 mm, 17 mm, 19 mm, 22 mm, 24 mm

PIN-734H AA23014

EMPAQUE	PZAS.	PESO	GARANTÍA
Portafolio	1/4	5 Kg	1 año

Pistola de impacto con kit de dados

Wrench with Sockets

3/4"

6 CFM

- Torque Variable
- Máximo: 720 lb/ft
- Incluye 2 dados: 32 mm y 36 mm
- Includes impact sockets: 32 mm y 36 mm



PINK-3/4 AA23017

EMPAQUE	PZAS.	PESO	GARANTÍA
Portafolio	1/3	6.3 Kg	1 año

Pistola de impacto vástago largo 6"

Wrench 6" anvil

1"

9 CFM

Sistema "twin hammer"
Torque: 2500 lb/ft



PIN-16 AA23009

EMPAQUE	PZAS.	PESO	GARANTÍA
Caja Color	2	12.6 Kg	1 año





Kits de Emergencia / EMERGENCY KITS

Kit básico

Basic kit



KHF-9062MI AA03012

EMPAQUE	PZAS.	PESO	GARANTÍA
Estuche de vinil	1	0.5 Kg	6 meses

CONTENIDO

Estuche, Desarmador plano, Desarmador de cruz, 4 Llaves españolas, 8/9,10/11, 12/13, 14/15 mm, Pinza de mecánico / Foldable case, Flat blade screwdriver, philips head screwdriver wrenches 8/9, 10/11, 12/13, 14/15 mm, pliers.

Kit tipo cartera

Wallet type kit



KIT-10 AA03015

EMPAQUE	PZAS.	PESO	GARANTÍA
Estuche de tela	10	0.92 Kg	6 meses

CONTENIDO

4 Llaves españolas 8 y 9 mm, 10 y 11 mm, 12 y13 mm, 14 y 15 mm Desarmador plano Desarmador de cruz 6"x100 mm, Pinzas de mecánico de 6", Calibrador de presión CL-1, Martillo, Estuche MIKEL'S tipo cartera / 4 Wrenches: 8 y 9 mm, 10 y 11 mm, 12 y13 mm, 14 y 15 mm Flat head screwdriver: 6"x100 mm, Phillips screwdriver: 6"x100 mm, 6" slip joint pliers, Pressure gauge, hammer, Folding wallet

Kit de emergencia automotriz

Automotive emergency kit



KEA-8 AA03007

EMPAQUE	PZAS.	PESO	GARANTÍA
Estuche de tela	1	1.8 Kg	6 meses

CONTENIDO

Estuche, Triángulo reflejantes 10", Desarmador plano, Desarmador de cruz, Pinza de mecánico, Cables pasacorriente 2.4M calibre 10, Lámpara Manual Recargable, Guantes de Algodón con puntos de PVC / Bag, 10" Reflective triangle, flat blade screwdriver, hilips head screwdriver, pliers, booster cables 2.4 M x gauge 10, Rechargeable Lamp, Cotton gloves with PVC Dots.

Kit de emergencia básico

Basic emergency kit



KIT-1 AA03014

EMPAQUE	PZAS.	PESO	GARANTÍA
Maleta	1	4.2 Kg	6 meses

CONTENIDO

Maleta rectangular, Infallantas 445 ml, Cuerda trenzada, Triángulo reflejante 17", Cables pasa corriente 2.4M calibre 10, Calibrador tipo pluma / Rectangular Bag, Magic tire 445 ml. Tow rope, 17" reflector triangle, Booster cables 2.4 M x gauge 10, Pencil air presure gauge

Kit de emergencia básico

Basic emergency Kit



KHS-9170MI AA03013

EMPAQUE	PZAS.	PESO	GARANTÍA
Estuche de tela	6	4 Kg	6 meses

CONTENIDO

Estuche, Triángulo reflejante 17", Cables pasacorriente 2.4M calibre 10, 4 Llaves españolas: 8 y 9 mm, 10 y 11 mm, 12 y 13 mm, 14 y 15 mm, Pinza de mecánico, Desarmador plano, Desarmador de cruz, Guantes de Algodón con puntos de PVC, Impermeable Tipo Manga / Bag, 17" Reflective triangle, booster cables 2.4 M x gauge 10, 4 Wrenches, pliers, Flat head screwdriver: 6"x100 mm, Flat head screwdriver: 6"x100 mm Phillips screwdriver: 6"x100 mm, Cotton gloves with PVC Dots, Raincoat

Kit de seguridad automotriz 1 t

Automotive security kit 1t



KIT-11 AA03017

EMPAQUE	PZAS.	PESO	GARANTÍA
Estuche de tela	1	6 Kg	1 año

CONTENIDO

4 Llaves españolas : 8 y 9 mm, 10 y 11 mm,12 y 13 mm, 14 y 15 mm, Desarmador plano, Desarmador de cruz, Juego de cables pasacorriente, Triángulo reflejante 17", Pinza de mecánico, Maleta rectangular, Gato de tijera 1t / 4 Wrenches, Flat head screwdriver: 6"x100 mm, Phillips screwdriver: 6"x100 mm, Booster cables: 2.4 m x gauge 10, 17" Reflective triangle, pliers, Rectangular Bag, 1t scissor jack





Kits de Emergencia / EMERGENCY KITS

Kit de emergencia automotriz

Emergency kit



KIT-4 AA03019

EMPAQUE	PZAS.	PESO	GARANTÍA
Estuche de tela	1	6.9 Kg	6 meses

CONTENIDO

4 Llaves españolas: 8 y 9 mm, 10 y 11 mm, 12 y 13 mm, 14 y 15 mm, Desarmador plano: 6"x100 mm, Desarmador de cruz: 6"x100 mm, Juego de cables pasacorriente: 2.4 m calibre 10 Extintor 1 kg, 2 Triángulos reflejantes 17", Pinza de mecánico, Maleta rectangular / 4 Wrenches, Flat head screwdriver, Phillips screwdriver, booster cables, 1 kg extinguisher, 17" Reflective triangles, Pliers, Rectangular Bag

Kit de asistencia en el camino

On The Road Assistance kit



KIT-9153MI AA03023

EMPAQUE	PZAS.	PESO	GARANTÍA
Estuche de tela	1	6.5 Kg	6 meses

CONTENIDO

Estuche, Triángulos reflejantes 17", Extintor 1kg, Infallantas 445 ml, Cables pasacorriente 2.4M calibre 10, 4 Llaves españolas: 8 y 9 mm, 10 y 11 mm, 12 y 13 mm, 14 y 15 mm, Pinza de mecánico, Desarmador plano: 6"x100 mm, Desarmador de cruz: 6"x100 mm, Guantes de Algodón con puntos de PVC, Impermeable Tipo Manga / Bag, 17" Reflective triangle, 1 Kg extinguisher, Magic tire, booster cables 2.4 M x gauge, 4 Wrenches, pliers, Flat head screwdriver, Phillips screwdriver, Cotton gloves with PVC Dots, Raincoat

Kit de emergencia automotriz

Automotive Emergency kit



KEM-9162MI AA03009

EMPAQUE	PZAS.	PESO	GARANTÍA
Estuche de tela	1	4.5 Kg	6 meses

CONTENIDO

Estuche, Triángulos reflejantes 10", Extintor 1kg, Infallantas 445 ml, Cables pasacorriente 2.4m calibre 8, Lámpara de emergencia 4 en 1 LMF-8, Multiherramientas 28 en 1 / Bag, 10" Reflective triangle, 1 Kg extinguisher, Magic tire 445 ml, booster cables, 4 In 1 lantern, 28 In 1 multitool

Kit de apoyo vial

Vehicle Assistance Kit



KAV-9223MI AA03003

EMPAQUE	PZAS.	PESO	GARANTÍA
Estuche de tela	1	4.7 Kg	6 meses

CONTENIDO

Estuche, Extintor 500g, Infallantas 445 ml, Cables pasacorriente 2.4M calibre 10, 4 Llaves españolas: 8 y 9 mm, 10 y 11 mm, 12 y 13 mm, 14 y 15 mm, Pinza de mecánico, Desarmador plano: 6"x100 mm, Desarmador de cruz: 6"x100 mm, Guantes de Algodón con puntos de PVC, Impermeable Tipo Manga, Cinturones elásticos-bungiees 8 piezas, Lámpara de emergencia 4 en 1 LMF-8, Maletín Primeros Auxilios / bag, 500g extinguisher, Magic tire, booster cables, Wrenches, pliers, Flat head screwdriver, Phillips screwdriver, Cotton gloves with PVC Dots, Raincoat, 8 Pieces bungees, 4 In 1 lantern, First aid Kit

Kit para excursión

Excursion kit



KIT-2 AA03018

EMPAQUE	PZAS.	PESO	GARANTÍA
Maleta	1	4.5 Kg	6 meses

CONTENIDO

Cinturones tensores 2 piezas T-2, Cuerda trenzada, Multiherramientas 28 en 1, Calibrador profesional CP-1, Compresor 4 en 1 W-1557 12V Maleta grande para herramientas MHG-16 / 2 Peces tie down belts, Tow rope, 28 In 1 multitool, Professional tire gauge, 4 In 1 air compressor, Tool bag

Kit de auxilio vial 1.5 t

1.5 t road side aid kit



KIT-9 AA03022

EMPAQUE	PZAS.	PESO	GARANTÍA
Estuche de tela	1	5 Kg	1 año

CONTENIDO

Ideal para Minivans, SUV's, Único en México 4 Llaves españolas: 8 y 9 mm, 10 y 11mm, 12 y 13 mm, 14 y 15 mm, Desarmador plano: 6"x100 mm, Desarmador de cruz: 6"x100 mm Pinza de mecánico, Maleta, Martillo, Gato de botella telescópico de 1.5 t / Crossovers y Pick Up's, 4 Wrenches, Flat head screwdriver, Phillips screwdriver, pliers, Bag, hammer, 1.5 t bottle telescopic jack





Kits de Emergencia / EMERGENCY KITS

Kit de asistencia vial Assistance kit



KAV-BMWMI AA03005

EMPAQUE	PZAS.	PESO	GARANTÍA
Estuche de tela	1	5.5 Kg	6 meses

CONTENIDO

Estuche, Triángulo reflejante 10", Extintor 450 g, Multiherramientas 27 en 1, Guantes de Algodón con puntos de PVC, Calibrador Digital CPD-1, Lámpara tipo Minero LTMI-3AAA, Chaleco de Seguridad, Cuerda trenzada, Cables pasacorriente 2.4M calibre 8 / Bag, 10" Reflective triangle, 450 g extinguisher, 27 In 1 multitool, Cotton gloves with PVC Dots, Digital tire gauge, Head Lamp, Safety Vest, Tow rope, Booster cables 2.4 M x gauge 8.

Kit reglamento de tránsito Transit kit



KRT-R AA03030

EMPAQUE	PZAS.	PESO	GARANTÍA
Estuche de tela	1	2 Kg	6 meses

CONTENIDO

Estuche, 2 Triángulos reflejantes 10", Extintor 300 g, Guantes de Algodón con puntos de PVC, Lámpara 3 Focos LED, Desarmador plano, Desarmador de cruz, Pinza de mecánico / bag, 10" Reflective triangle, 450 g extinguisher, Cotton gloves with PVC Dots, Head Lamp, flat blade screwdriver, Phillips head screwdriver, pliers.

Kit gato de botella 2.5 t 2.5 t bottle jack kit



KGH-1812MI AA03010

EMPAQUE	PZAS.	PESO	GARANTÍA
Maleta	1	14 Kg	1 año

CONTENIDO

Bolsa horizontal, Gato de botella telescópico 2.5 t, Extintor 2 kg, 2 Triángulos reflejantes 17", Llave de artillería con palanca 19 mm, Extensión de palanca / horizontal bag, 2.5t telescopic bottle jack, 2 kg Extinguisher, 17" Reflective triangles, 19 mm artillery wrench, Extension lever.

Kit para camiones con gato 8 t 8 t trucks kit



KS-532-1 AA03028

EMPAQUE	PZAS.	PESO	GARANTÍA
Maleta	1	16 Kg	1 año

CONTENIDO

Bolsa, Gato de botella 8 t, Extintor 2 kg, 2 Triángulos reflejantes 17" Llave de artillería con maneral de 33 mm, Extensión de palanca / Bag, 2.5t telescopic bottle jack, 2 kg Extinguisher, 17" Reflective triangles, 19 mm artillery wrench, Extension lever.

Kit para camiones gato 12 t 12 t jack kit



KS-532MI AA03026

EMPAQUE	PZAS.	PESO	GARANTÍA
Maleta	1	20 Kg	6 meses

CONTENIDO

Bolsa, 3 Triángulos reflejantes 17", Extintor 2kg, Gato de botella 12 t, Llave de artillería con maneral de 33 x 38 mm / Bag, 17" Reflective triangles, 2 Kg extinguisher, 12 t bottle jack, 33 X 38 mm iron wrench with level.

Kit para camiones con gato 20 t 20 t trucks kit



KIT-8007 AA03027

EMPAQUE	PZAS.	PESO	GARANTÍA
Maleta	1	22.8 Kg	6 meses

CONTENIDO

3 Triángulos reflejantes 17", Llave de artillería con maneral 33 mm, Bolsa de vertical, Gato de botella 20 t / 3 Reflective triangles, Heavy duty wrench with lever, Vertical bag, 20 t bottle jack.





Llaves de Artillería / GUNNER WRENCHES



BOCA HEXAGONAL
Hex socket

Llave 7/8", 13/16"

Wrench

T-4 AA05030 **22-20.6 mm**

EMPAQUE	PZAS.	PESO	GARANTÍA
Caja Color	1/12	2.1 Kg	1 año

Caja Color 1/12 2.1 Kg 1 año



Boca Hexagonal
Hexagonal Socket

Llave 1 1/16", 11/4"

Wrench

T-9 AA05033 **27-32 mm**

EMPAQUE	PZAS.	PESO	GARANTÍA
Caja Color	6	2.75 Kg	1 año

Caja Color 6 2.75 Kg 1 año



Boca Hexagonal
Hexagonal Socket

Llave 1, 11/4"

Wrench

T-33 AA05029 **33 mm**

EMPAQUE	PZAS.	PESO	GARANTÍA
Caja Color	6	2.9 Kg	1 año

Caja Color 6 2.9 Kg 1 año



Boca Hexagonal
Hexagonal Socket

Llave 1 1/2", 13/16" Maneral 7/8" x 20"

Wrench

T-10 AA05028 **38-208 mm**

EMPAQUE	PZAS.	PESO	GARANTÍA
Caja Color	4	2.1 Kg	1 año

Caja Color 4 2.1 Kg 1 año



Boca Hexagonal
Hexagonal Socket



Boca Cuadrada
Square Socket

Espátula puntas planas

Tire spoon

T-402 AA05031

EMPAQUE	PZAS.	PESO	GARANTÍA
Atado	1	1.4 Kg	1 año

Atado 1 1.4 Kg 1 año



28.5" 3/4" x 724 mm



Espátula de uña puntas planas

Tire spoon

T-E1 AA05036

EMPAQUE	PZAS.	PESO	GARANTÍA
Atado	1/15	1.2 Kg	1 año

Atado 1/15 1.2 Kg 1 año



11/16" x 660 mm



Despegador de ceja (bazooka)

Bead braker - Bazooka

DCB-110 AA05047

EMPAQUE	PZAS.	PESO	GARANTÍA
Caja	1	12 Kg	1 año

Caja 1 12 Kg 1 año



110 cm de largo

NEW!

Industrial pavonada

Industrial black wrench



7/8" x 13/16"

LLA-D4 AA05020

EMPAQUE	PZAS.	PESO	GARANTÍA
Granel	12	1.74 Kg	2 años

Granel 12 1.74 Kg 2 años

15/16" x 7/8"

LLA-D5 AA05021

EMPAQUE	PZAS.	PESO	GARANTÍA
Granel	12	1.7 Kg	2 años

Granel 12 1.7 Kg 2 años

1-1/16" x 1"

LLA-D6 AA05022

EMPAQUE	PZAS.	PESO	GARANTÍA
Granel	12	2.2 Kg	2 años

Granel 12 2.2 Kg 2 años

1-1/8" x 7/8"

LLA-D7 AA05023

EMPAQUE	PZAS.	PESO	GARANTÍA
Granel	12	2.2 Kg	2 años

Granel 12 2.2 Kg 2 años

1-1/18" x 1"

LLA-D8 AA05024

EMPAQUE	PZAS.	PESO	GARANTÍA
Granel	12	2.3 Kg	2 años

Granel 12 2.3 Kg 2 años

33mm x 27mm

LLA-D33 AA05018

EMPAQUE	PZAS.	PESO	GARANTÍA
Granel	10	2 Kg	2 años

Granel 10 2 Kg 2 años

33 mm

LLA-D33P AA05019

EMPAQUE	PZAS.	PESO	GARANTÍA
Granel	12	2.8 Kg	2 años

Granel 12 2.8 Kg 2 años

38.1 mm x 20.6mm

LLA-D10 AA05017

EMPAQUE	PZAS.	PESO	GARANTÍA
Granel	12	3.1 Kg	2 años

Granel 12 3.1 Kg 2 años





Manerales para llave de artillería industrial

Industrial black handle



Ø11/16" x 50cm

MAN-M1 AA05025

EMPAQUE	PZAS.	PESO	GARANTÍA
Granel	30	0.9 Kg	2 años

Ø0.911" x 40cm

MAN-M2 AA05026

EMPAQUE	PZAS.	PESO	GARANTÍA
Granel	30	1.3 Kg	2 años

Llaves de Cruz / CROSS WRENCHES

Cromada

Chromed

14"
13/16" - 3/4" - 17mm - 7/8"



CC-2 AA05007

EMPAQUE	PZAS.	PESO	GARANTÍA
Caballote	20	1.2 Kg	1 año

Cromada

Chromed

18"
13/16" - 3/4" - 17mm - 7/8"



CC-1 AA05005

EMPAQUE	PZAS.	PESO	GARANTÍA
Caballote	12	1.5 Kg	1 año

Cromada

Chromed

20"
13/16" - 3/4" - 17mm - 7/8"



CC-3 AA05008

EMPAQUE	PZAS.	PESO	GARANTÍA
Caballote	12	1.6 Kg	1 año

Galvanizada

Galvanized

18"
13/16" - 3/4" - 17mm - 7/8"



LCT-18 BA05001

EMPAQUE	PZAS.	PESO	GARANTÍA
Caballote	12	1.45 Kg	6 meses

Reforzada

Reinforced

19"
13/16" - 3/4" - 17mm - 7/8"



CC-9 AA05010

EMPAQUE	PZAS.	PESO	GARANTÍA
Caballote	1	1.9 Kg	2 años



Reforzada

Reinforced

26"
7/8", 1", 1 1/8"



CC-11 AA05004

EMPAQUE	PZAS.	PESO	GARANTÍA
Caballote	1	3.5 Kg	2 años



Llave de cruz cromada plegable

Foldable Chrome Finish

14"
13/16" - 3/4" - 17mm - 7/8"



Brazos plegables

CC-14P AA05066

EMPAQUE	PZAS.	PESO	GARANTÍA
Funda	6/12	1.3 Kg	1 año

Llave Telescópica

Telescopic wrench

17mm~19mm / 21mm~23mm

CC-8 AA05009

EMPAQUE	PZAS.	PESO	GARANTÍA
Blister	6	1 Kg	1 año



Incluye:

- Maneral Telescópico (35 cm - 52.5 cm)
- Bolsa de almacenaje
- 2 Dados: 17 mm ~19 mm y 21 mm ~23 mm

Dados fabricados en Cromo Vanadio





Lubricación / LUBRICATION

Aceiteras de presión Bote de Acero, tubo flexible

Flexible tubing

160 ml



A1F AA09002

EMPAQUE	PZAS.	PESO	GARANTÍA
Caja	12	0.1 Kg	1 año

250 ml



A2F AA09006

EMPAQUE	PZAS.	PESO	GARANTÍA
Caja	12	0.2 Kg	1 año

500 ml



A3F AA09010

EMPAQUE	PZAS.	PESO	GARANTÍA
Caja	12	0.2 Kg	1 año

1000 ml



Z5F AA09039

EMPAQUE	PZAS.	PESO	GARANTÍA
Caja	12	0.4 Kg	1 año

Aceiteras de presión Bote de Acero, tubo rígido

Rigid tubing

160 ml



A1R AA09004

EMPAQUE	PZAS.	PESO	GARANTÍA
Caja	12	0.1 Kg	1 año

250 ml



A2R AA09008

EMPAQUE	PZAS.	PESO	GARANTÍA
Caja	12	0.2 Kg	1 año

500 ml



A3R AA09012

EMPAQUE	PZAS.	PESO	GARANTÍA
Caja	12	0.2 Kg	1 año

1000 ml



Z5R AA09041

EMPAQUE	PZAS.	PESO	GARANTÍA
Caja	12	0.4 Kg	1 año

Carrete con manguera para aceite

Hose reel for Oil

1/2" (12.7 mm)

2000 PSI (Presión Máxima)

Incluye:

- Base
- Doble soporte

Includes:

- Base
- 2 arm support



CMA-1/2 AA09020

EMPAQUE	PZAS.	PESO	GARANTÍA
Caja Color	1	23 Kg	2 años

Carrete con manguera para grasa

Hose reel for grease

1/4" (6.4 mm)

5000 PSI (Presión Máxima)

Incluye:

- Base
- Doble soporte

Includes:

- Base
- 2 arm support



CMG-1/4 AA09023

EMPAQUE	PZAS.	PESO	GARANTÍA
Caja Color	1	22 Kg	2 años





Lubricación / LUBRICATION

Cubeta manual para grasa

Manual for grease

4 kg



CMG-4 AA09044

EMPAQUE	PZAS.	PESO	GARANTÍA
Caja Color	1	4.5 Kg	1 año

Cubeta manual para grasa

Manual for grease

6 kg



CMG-6 AA09045

EMPAQUE	PZAS.	PESO	GARANTÍA
Caja Color	1	5.3 Kg	1 año

Cubeta manual para aceite

Manual for oil

16 lts

- Manguera de 1.7 m de largo
- Práctica boquilla con válvula antigoteo
- Despacha 250 ml por bombeo en función de la viscosidad
- Hose 1.7 m long
- Practice drip nozzle valve dispensed 250 ml per pumping plunger.



CMA-16 AA09021

EMPAQUE	PZAS.	PESO	GARANTÍA
Caja	1	7.4 Kg	6 meses

Cubeta manual para grasa

Manual for grease

16 kg

- Manguera de 1.7 m de largo
- Práctica boquilla que evita el goteo
- Despacha 1 g de grasa por bombeo en función de la viscosidad
- Hose 1.7 m long
- Practice prevents dripping nozzle dispatches pumping plunger.



CMG-16 AA09024

EMPAQUE	PZAS.	PESO	GARANTÍA
Caja	1	7.5 Kg	6 meses

Cubeta engrasadora de pedal

Pedal of grease

10 kg



CEP-10 AA09019

EMPAQUE	PZAS.	PESO	GARANTÍA
Caja	1	13.6 Kg	1 año

Cubeta con bomba manual para grasa

Manual bucket for grease

19 kg

- Despacha 9 g. de grasa en función de la viscosidad.
- Presión máxima de trabajo: 1740 PSI.
- Manguera de alta presión de 1.5 m de largo con extensión de acero y boquilla hidráulica.
- Dimensiones de la cubeta: 42 x 80 cm

- Delivers 9 g. Of grease per cycle.
- Max. Working pressure: 1740 psi.
- High pressure hose, 1.5 m. long with steel extension and hydraulic nozzle.
- Bucket dimensions: 42 x 80 cm



CMG-19 AA09025

EMPAQUE	PZAS.	PESO	GARANTÍA
Caja	1	8.8 Kg	6 meses

Cubeta con bomba manual para aceite

Manual bucket for oil

19 lts

- Despacha 200 ml. en función de la 12 kg viscosidad.
- Manguera de hule de 1/2" x 1.50 m de largo.
- Dimensiones de la cubeta: 42 x 80 cm
- Delivers 200 ml. of liter per cycle.
- 1/2" X 1.50 M plastic hose.
- Bucket dimensions: 42 x 80 cm.



CMA-19 AA09022

EMPAQUE	PZAS.	PESO	GARANTÍA
Caja	1	9.3 Kg	6 meses

Cubeta engrasadora neumática

Grease Pump

12 kg

Incluye accesorios



CEN-12 AA09017

EMPAQUE	PZAS.	PESO	GARANTÍA
Caja	1	13.5 Kg	6 meses

Cubeta engrasadora neumática

Pneumatic Grease

30 kg

- En el interior del tanque cabe perfectamente una cubeta de 19 Kg
- Incluye accesorios manual que facilita el transporte
- Inside the tank perfectly fits bucket 19 kg
- Includes accessories material that facilitates transport



CEN-30 AA09018

EMPAQUE	PZAS.	PESO	GARANTÍA
Caja	1	19.5 Kg	6 meses





Lubricación / LUBRICATION

Bomba extractora de solventes para tambo de 200 lts

200 L Barrel Pump for Corrosives



- Boquilla removible con cuerda.
- Tubo de 3.8 cm de diámetro.
- Removable head with screw
- Pipe diameter 3.8 cm

BES-200	AA09014		
EMPAQUE	PZAS.	PESO	GARANTÍA
Caja Color	12	18.6 Kg	6 meses

Bomba rotativa universal

Universal Swivel Pump



Longitud del Tubo de 1m
Pipe Length 1m

JS-32	AA09033		
EMPAQUE	PZAS.	PESO	GARANTÍA
Caja Color	4	4.7 Kg	6 meses

Bomba rotativa para líquidos corrosivos

Universal Swivel Pump

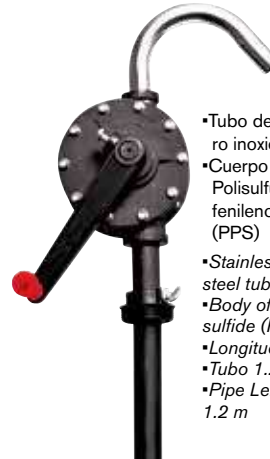

- Tubo de acero inoxidable
- Cuerpo de Polisulfuro de fenileno (PPS)
- Stainless steel tube
- Body of polysulfide (PPS)
- Longitud del Tubo 1.2 m
- Pipe Length 1.2 m

BLC-1	AA09016		
EMPAQUE	PZAS.	PESO	GARANTÍA
Caja Color	10	2.6 Kg	6 meses

Bomba rotativa para agua

Swivel water pump



Longitud del Tubo de 1.2 m
Pipe Length 1.2 m

BPRA-1	AA09048		
EMPAQUE	PZAS.	PESO	GARANTÍA
Caja Color	4	2.6 Kg	6 meses

Bomba extractora para tambo

Barrel Pump Pipe

Extensión del tubo 87 cm



BET-1	AA09015		
EMPAQUE	PZAS.	PESO	GARANTÍA
Caja Color	10	2 Kg	6 meses

Extractor de aceite

Oil extractor

Manguera flexible de 30.5 cm 500 c.c.



Excelente para cigüeñales, diferenciales, engranajes, transmisiones, etc.

EX-A	AA09028		
EMPAQUE	PZAS.	PESO	GARANTÍA
Caja Color	20	0.8 Kg	6 meses

Recibidor de aceite

Oil receiver

45 lts

- Charola: 48.5 cm ø
- Altura máxima: 142 cm
- Altura mínima: 106 cm
- Oil tray: 48.5 cm ø
- Maximum Height: 142 cm
- Minimum Height: 106 cm



RAU-45	AA09046		
EMPAQUE	PZAS.	PESO	GARANTÍA
Caja Color	1	20 Kg	1 año

Recibidor neumático de aceite

Oil receiver

80 lts

- Charola 35 cm ø
- Altura máxima: 195 cm
- Altura mínima: 120 cm
- Oil tray 35 cm ø
- Maximum Height: 195 cm
- Minimum Height: 120 cm



Incluye manguera para el vaciado

RAU-80	AA09037		
EMPAQUE	PZAS.	PESO	GARANTÍA
Caja	1	27 Kg	1 año

Extractor neumático de aceite

Oil extractor

23 lts



EAN-23	AA09026		
EMPAQUE	PZAS.	PESO	GARANTÍA
Caja	1	13.7 Kg	1 año

Dispensador neumático de aceite

Pneumatic Oil delivery tank

70 lts



DNA-70	AA09047		
EMPAQUE	PZAS.	PESO	GARANTÍA
Caja	1	20 Kg	1 año

Recibidor extractor de aceite neumático

Pneumatic Oil delivery tank

70 lts

- Altura máxima: 185 cm
- Altura mínima: 140 cm
- Maximum Height: 185 cm
- Minimum Height: 140 cm



RENA-70	AA09049		
EMPAQUE	PZAS.	PESO	GARANTÍA
Caja	1	40 Kg	1 año

@mikels tools

mikels.com.mx





Lubricación / LUBRICATION

Inyector de grasa tipo pistola tubo rígido

Pistol type grease gun
4500 PSI
120 c.c.



Cromado, cilindro robusto y estriado para un agarre seguro. Uso Vertical

IGP-1	AA09032	EMPAQUE	PZAS.	PESO	GARANTÍA
		Caja Color	1/30	0.7 Kg	6 meses

Inyector de grasa tipo pistola

Grease gun.
4500 PSI
500 c.c.



IGP-2	AA09043	EMPAQUE	PZAS.	PESO	GARANTÍA
		Caja Color	1/10	1.3 Kg	6 meses

Inyector de grasa tipo palanca

Grease injector
6000 PSI
500 c.c.



Tubo rígido y manguera flexible de 9"

IG-P	AA09031	EMPAQUE	PZAS.	PESO	GARANTÍA
		Caja Color	1/15	1.3 Kg	6 meses

Inyector de grasa tubo rígido

Grease injector
6000 PSI
510 c.c.



Accionamiento manual para graseras

IGPP	AA09032	EMPAQUE	PZAS.	PESO	GARANTÍA
		Caja Color	1/12	1.2 Kg	1 año

Inyector de grasa

Grease injector - with rigid sprout
6000 PSI
500 c.c.



Tubo rígido y manguera flexible de 9"

IG	AA09029	EMPAQUE	PZAS.	PESO	GARANTÍA
		Caja Color	12	1.55 Kg	6 meses

Inyector de grasa doble pistón

Double piston grease injector
6000 PSI
500 c.c.



IG-DP	AA09042	EMPAQUE	PZAS.	PESO	GARANTÍA
		Caja Color	1/10	1.7 Kg	6 meses

Inyector de grasa neumático

Pneumatic grease gun
4800 PSI
500 c.c.



Tubo rígido y manguera flexible

IG-N	AA09030	EMPAQUE	PZAS.	PESO	GARANTÍA
		Caja Color	10	1.6 Kg	6 meses

Manguera flexible

Flexible hose
12" (30.48 cm)
1/8" NPT



MI/12	AA09034	EMPAQUE	PZAS.	PESO	GARANTÍA
		Blister	100	0.09 Kg	6 meses

Manguera flexible

Flexible hose
18" (45.72 cm)
1/8" NPT



MI/18	AA09035	EMPAQUE	PZAS.	PESO	GARANTÍA
		Blister	100	0.1 Kg	6 meses

Boquilla para inyector

Grease injector coupler
1/8" NPT



B/I	AA09013	EMPAQUE	PZAS.	PESO	GARANTÍA
		Blister	10	0.03 Kg	6 meses





Plumas Hidráulicas para Motor /ENGINE HOISTS

Plegable

Foldable

1 t



T-1300 AA01071

EMPAQUE	PZAS.	PESO	GARANTÍA
Caja	1 Pza (2 Cajas)	75 Kg	1 año

Plegable

Foldable

2 t

Patas que se doblan hacia arriba para un rápido y fácil almacenaje.



T-1475 AA01074

EMPAQUE	PZAS.	PESO	GARANTÍA
Caja	1 Pza (2 Cajas)	68 Kg	1 año

Neumática plegable

Pneumatic foldable

2 t

Ahorra un 65% de espacio, brazo telescópico con 4 posiciones ajustables



TH-1473 AA01079

EMPAQUE	PZAS.	PESO	GARANTÍA
Caja	1 Pza (2 Cajas)	88 Kg	1 año

Con extensiones

Extendable

2 t

Extensiones en los brazos frontales y laterales para obtener una gran estabilidad.



T-1473 AA01073

EMPAQUE	PZAS.	PESO	GARANTÍA
Caja	1 Pza (2 Cajas)	125 Kg	1 año

Con extensiones frontales

With front extensions

3 t



T-3000 AA01075

EMPAQUE	PZAS.	PESO	GARANTÍA
Caja	1 Pza (2 Cajas)	140 Kg	1 año

Grúa para camioneta

Lifting crane

454 kg

Altura mínima: 0
Minimum Height
Altura máxima: 201.5 cm
Maximum Height



Se ancla a la caja de una pick-up, grúa de elevación con mecanismo giratorio de 360°

137 cm

27 cm

GPC-454 AA01044

EMPAQUE	PZAS.	PESO	GARANTÍA
Caja	1 Pza (2 Cajas)	48 Kg	1 año

MODELO /MODEL	T-1300				T-1475				T-1473				TH-1473				T-3000			
Posición / Position	P1	P2	P3	P4	P1	P2	P3	P4	P1	P2	P3	P4	P1	P2	P3	P4	P1	P2	P3	P4
Capacidad / Capacity t	1000	750	500	250	2000	1500	1000	500	2000	1500	1000	500	2000	1500	1000	250	3000	2000	1500	1000
Altura Mínima / Minimum Height cm	35.5	27	18.5	10	30.5	150	0	0	57	42	27	11	30.5	15	0	0	30	15	0	0
Altura Máxima / Maximum Height cm	186	193.5	201	209	194	209.5	224	238	221	235	250	263	194	209	224	238	195	208	122	231
Extensión del Brazo / Arm's Extension cm	90	99	108	116	103.5	122	140	158	103.5	122	140	158	103.5	122	140	158	137	158	179	199
Ancho Total / Overall Width cm	122.5 x 94.5 x 23.5				170 x 80 x 55				161 x 86 x 151				185 x 107 x 148				145 x 170 x 155			
Medidas de la Base / Base Dimensions cm	129 x 68 x 97				183 x 80 x 108				129 x 145 x 70				182 x 80 x 108				127 x 76 x 95			





Presas hidráulicas / HYDRAULIC PRESSES

De Banco con pistón

Piston
4 t



PHB-4T	AA01066		
EMPAQUE	PZAS.	PESO	GARANTÍA
Caja	1	32 Kg	1 año

Con Gato hidráulico

Hydraulic bottle jack
12 t



PH-12	AA01059		
EMPAQUE	PZAS.	PESO	GARANTÍA
Caja	1 Pza (2 Cajas)	49 Kg	1 año

Con Pistón y manómetro

Piston and gauge
15 t



PHB-15	AA01065		
EMPAQUE	PZAS.	PESO	GARANTÍA
Caja	1 Pza (2 Cajas)	91 Kg	1 año

Con gato hidráulico

Hydraulic bottle jack
20 t



PH-20	AA01061		
EMPAQUE	PZAS.	PESO	GARANTÍA
Caja	1 Pza (2 Cajas)	130 Kg	1 año

Con Gato hidráulico

Hydraulic bottle jack
30 t



PH-30	AA01063		
EMPAQUE	PZAS.	PESO	GARANTÍA
Caja	1	216 Kg	1 año

Con pistón y pedal

Piston and footpedal operation
30 t

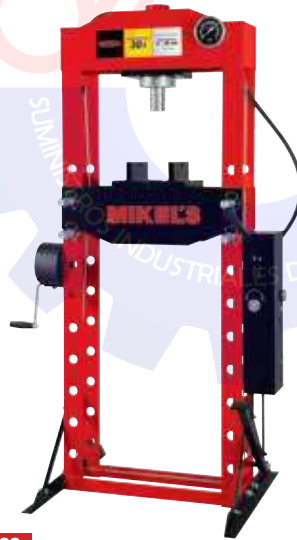

PHP-30	AA01087		
EMPAQUE	PZAS.	PESO	GARANTÍA
Caja madera	1	206 Kg	1 año

Con Pistón y manómetro

Piston and gauge
20 t
Bomba Doble
Twin pump



PHB-25	AA016011		
EMPAQUE	PZAS.	PESO	GARANTÍA
Caja	1 Pza (2 Cajas)	90 Kg	1 año

MODELO / MODEL	PHB-4T	PH-12	PHB-15	PH-20	PH-30	PHP-30	PHB-25
Recorrido Hidráulico / Hydraulic Stroke cm	12	14	15	19	17	16	19
Rango de Trabajo / Working Range cm	0 - 33	0 - 70	0 - 95	0 - 92	0 - 77	16.6 - 112.6	0 - 95
Dimensiones de la Prensa / Press Dimensions cm	65 x 28 x 100	50 x 42 x 125	80 x 50 x 186	74 x 59 x 150	78 x 60 x 160	78 x 27 x 192	70 x 76.3 x 180





Prensas hidráulicas / HYDRAULIC PRESSES

Con Pistón y manómetro

Piston and gauge

50 t

Bomba Doble
Twin pump



PHB-50 AA01067

EMPAQUE	PZAS.	PESO	GARANTÍA
Caja Madera	1 Pza (2 Cajas)	280 Kg	1 año

Con Gato hidráulico

Hydraulic bottle jack

12 t

Tctmer



PHT-12 BA01014

EMPAQUE	PZAS.	PESO	GARANTÍA
Caja	1 Pza (2 Cajas)	44 Kg	6 meses

Con Gato hidráulico

With hydraulic bottle jack

20 t

Tctmer



PHT-20 BA01015

EMPAQUE	PZAS.	PESO	GARANTÍA
Caja	1 Pza (2 Cajas)	88.5 Kg	6 meses

Prensas Hidroneumáticas / HYDROPNEUMATIC PRESSES

Con Pistón y manómetro

Piston and gauge

30 t



PHB-30 AA016012

EMPAQUE	PZAS.	PESO	GARANTÍA
Caja	1 Pza (2 Cajas)	216 Kg	1 año

Con Pistón y manómetro

Piston and gauge

75 t

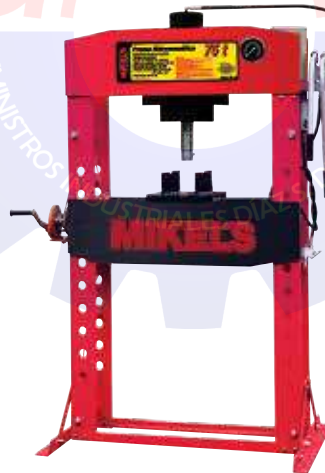

PHB-75 AA16013

EMPAQUE	PZAS.	PESO	GARANTÍA
Caja Madera	1	495 Kg	1 año

Con Pistón y manómetro

Piston and gauge

100 t



PHB-100 AA16010

EMPAQUE	PZAS.	PESO	GARANTÍA
Caja Madera	1	670 Kg	1 año

MODELO / MODEL	PHB-50	PHT-12	PHT-20	PHB-30	PHB-75	PHB-100
Recorrido Hidráulico / Hydraulic Stroke cm	19	14	19	18	25	30
Rango de Trabajo / Working Range cm	0 - 73	0 - 70	0 - 92	0 - 105	0 - 92	9 - 93
Dimensiones de la Prensa / Press Dimensions cm	80 x 132 x 190	50 x 42 x 125	74 x 59 x 150	85.5 x 95 x 190.5	106 x 40 x 212	120 x 99 x 205





Remolque / TRAILER

Bola de arrastre

Hitch ball
1-7/8"
2000 lbs



BA178-20	AE13019		
EMPAQUE	PZAS.	PESO	GARANTÍA
Colgador	12	0.8 Kg	1 año

Bola de arrastre

Hitch ball
2"
3500 lbs



BA2-35	AE13020		
EMPAQUE	PZAS.	PESO	GARANTÍA
Colgador	12	1 Kg	1 año

Bola de arrastre

Hitch ball
2"
5000 lbs



BA-5000	AE13027		
EMPAQUE	PZAS.	PESO	GARANTÍA
Colgador	20	1.2 Kg	1 año

Acoplador para arrastre

Trailer coupler
1-7/8"x 2"
2000 lbs



AC0178-20	AE13021		
EMPAQUE	PZAS.	PESO	GARANTÍA
Caja Color	6	1.2 Kg	1 año

Lengüeta de arrastre

Hitch ball mount
2 x 2"



LEN-22	AE13024		
EMPAQUE	PZAS.	PESO	GARANTÍA
Caja Color	6	2.9 Kg	1 año

Lengüeta de arrastre

Hitch ball mount
1-1/4" x 1-1/4"



LEN-14	AE13025		
EMPAQUE	PZAS.	PESO	GARANTÍA
Caja Color	6	2.1 Kg	1 año

Acoplador para arrastre

Trailer coupler
2 x 2"
3500 lbs



AC02-35	AE13022		
EMPAQUE	PZAS.	PESO	GARANTÍA
Caja Color	12	1.8 Kg	1 año

Kit de arrastre

Trailer set
3500 lbs



KAA-20	AE13026		
EMPAQUE	PZAS.	PESO	GARANTÍA
Funda	3	5 Kg	1 año

Gato para remolque

Trailer jack
1000 lbs

- Altura Máxima al punto de fijación 57.6 cm
- Carrera del pistón 25.4 cm
- Incluye accesorios de montaje
- Mecanismo de levante reforzado



GR-1000	AE13025		
EMPAQUE	PZAS.	PESO	GARANTÍA
Caja Color	2	6 Kg	1 año

Opresores de Resortes / SPRING COMPRESSORS

Hidráulico con bomba manual

Hdraulic vertical manual
1 t
Área máxima de trabajo: 203 mm
Recorrido hidráulico: 110 mm
Maximum work range: 203 mm
Ram: 110 mm



CRM-1	AA01002		
EMPAQUE	PZAS.	PESO	GARANTÍA
Caja Color	1	19 Kg	1 año

Manual vertical

Vertical manual
1 t



ORM-1	AA08034		
EMPAQUE	PZAS.	PESO	GARANTÍA
Caja	1	33 Kg	1 año

Hidráulico vertical fijo

Vertical spring
1 t



CRV-1	AA01003		
EMPAQUE	PZAS.	PESO	GARANTÍA
Caja	1	35 Kg	1 año

Neumático vertical

Vertical pneumatic
1 t



ORN-1	AA16008		
EMPAQUE	PZAS.	PESO	GARANTÍA
Caja	1	37.5 Kg	1 año





Soportes para Motor / ENGINE STANDS

Transversal ajustable

Beam height

500 kg

- Reguladores de altura.
- Soportes laterales de goma.
- Ideal para cambios de soportes de motor, clutch y para bajar cajas de transmisión.



Ajustable
Adjustable

STM-500 AA08023

EMPAQUE	PZAS.	PESO	GARANTÍA
Caja Color	1	19.4 Kg	6 meses

350 kg

Tubería mecánica de acero de medida pesada para prevenir la flexión excesiva del marco.

Montaje completamente ajustable que asegura la parte posterior del motor al soporte.



Medidas de la Base:
Base Dimensions
72.4 cm X 86.4 cm

500 kg

Tubería mecánica de acero de medida pesada para prevenir la flexión excesiva del marco.

Montaje completamente ajustable que asegura la parte posterior del motor al soporte.



Medidas de la Base:
Base Dimensions
77 cm X 86.4 cm

1000 kg

Tubería mecánica de acero de medida pesada para prevenir la flexión excesiva del marco.

Montaje completamente ajustable que asegura la parte posterior del motor al soporte.



Medidas de la Base:
Base Dimensions
102 cm X 88 cm

Plegable / Foldable

T-1083 AA08024

EMPAQUE	PZAS.	PESO	GARANTÍA
Caja	1	17 Kg	6 meses

T-1084 AA08025

EMPAQUE	PZAS.	PESO	GARANTÍA
Caja	1	19 Kg	6 meses

T-1085 AA08026

EMPAQUE	PZAS.	PESO	GARANTÍA
Caja	1	40 Kg	6 meses

Todos los soportes de motor tienen cabeza giratoria de 360° para óptima maniobrabilidad del motor. Cabezas ajustables para adaptarse adecuadamente a los diferentes tamaños y tipos de motor.

All metal wheels and structure. Rotating hend for easy engine maintenance and adjustments for different models and sizes.

Torres para Auto / JACK STANDS



2 t

Altura Mínima: 275 mm
Minimum Height
Altura Máxima: 420 mm
Maximum Height

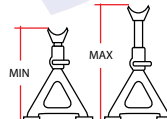

T-9350 AA08027

EMPAQUE	PZAS.	PESO	GARANTÍA
Caja Color	1 par	5.2 Kg	2 años

3 t

Altura Mínima: 285 mm
Minimum Height
Altura Máxima: 425 mm
Maximum Height

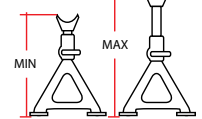

T-9360 AA08028

EMPAQUE	PZAS.	PESO	GARANTÍA
Caja Color	1 par	7 Kg	2 años

Para camión

For truck

12 t

Altura Mínima: 465 mm
Minimum Height
Altura Máxima: 750 mm
Maximum Height

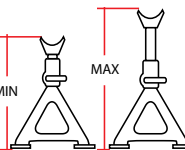

T-9392 AA08030

EMPAQUE	PZAS.	PESO	GARANTÍA
Caja Color	1 par	26.4 Kg	2 años

6 t

Altura Mínima: 390 mm
Minimum Height
Altura Máxima: 605 mm
Maximum Height

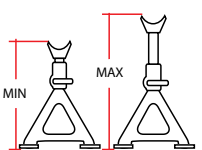

T-9366 AA08029

EMPAQUE	PZAS.	PESO	GARANTÍA
Caja Color	1 par	10.6 Kg	2 años

Para Tráiler / For Trailer and Truck

22 t

Altura Mínima: 330 mm
Minimum Height
Altura Máxima: 500 mm
Maximum Height



T-9322 AA08070

EMPAQUE	PZAS.	PESO	GARANTÍA
Caja	1 par	29 Kg	1 año



7821606595
7821604051
7821610766



contacto@sidadz.com



www.sidadz.com





TALLER DE SERVICIO AUTOMOTRIZ



PROGRAMA DE EQUIPOS AUTOMOTRICES PARA

TALLER DE HOJALATERÍA Y PINTURA





EQUIPOS DE LEVANTE



ACONDICIONAR TALLERES PROFESIONALES

HERRAMIENTA DE MANO Y ESTANTERÍA





Línea
Ciclismo





Bombas de aire / AIR PUMPS

Ergonómica

Ergonomic

120 PSI

Para válvulas:
Europea y Americana



Incluye pivote para balones, adaptador tipo boquilla y aguja
*120 PSI cylinder capacity
Includes ball needle, coupler and small adaptor*

BA-2 AE06003

EMPAQUE	PZAS.	PESO	GARANTÍA
Caja Color	12	1 Kg	6 meses

Con Manguera reforzada

Reinforced hose

170 PSI

Para válvulas:
Europea y Americana



Incluye pivote para balones, adaptador tipo boquilla y aguja
*170 PSI cylinder capacity
Includes ball needle, coupler and small adaptor*

BA-DA AB06003

EMPAQUE	PZAS.	PESO	GARANTÍA
Caja Color	10	1 Kg	6 meses

Mini Telescópica

Mini Telescopic

90 PSI

Para válvulas:
Europea y Americana



BAMT-1 AB06004

EMPAQUE	PZAS.	PESO	GARANTÍA
Caballote	100	0.2 Kg	6 meses

Para Bicicletas

For Bicycle

90 PSI

Para válvulas:
Europea y Americana



BAB-1 AB06002

EMPAQUE	PZAS.	PESO	GARANTÍA
Caballote	12 / 72	0.2 Kg	6 meses

Para inflar llantas

Air Pump

120 PSI

Para válvula Americana



B/NT BE06001

EMPAQUE	PZAS.	PESO	GARANTÍA
Caballote	12/72	0.8 Kg	6 meses

Multiherramienta para ciclista

Cyclist multitool

10 en 1



MHC-101 AB6009

EMPAQUE	PZAS.	PESO	GARANTÍA
Caja Color	1/6	0.3 Kg	1 año

Kits para Ciclista / BICYCLE TOOL KITS

Kit

Kit

15 en 1



INCLUYE:

- Funda de nylon
- Pegamento para caucho
- Raspador para goma
- Barras para desmontar llanta
- Desarmador de cruz
- Adaptador de 1/4"
- Llaves 8/10/15mm
- Llave 14 GE para rayos
- Juego de parches
- Llaves allen 2/2.5/3/4/5/6 mm
- Desarmador plano

KC-151 AB06005

EMPAQUE	PZAS.	PESO	GARANTÍA
Blister	1 / 48	0.3 Kg	6 meses

Kit

Kit

22 en 1



INCLUYE:

- 1 Multiherramientas 17 en 1
- 1 Juego de barras para desmontar llanta
- 1 Juego de parches
- 1 Pegamento de caucho
- 1 Bolsa de aire,
- 1 Bolsa de nylon para almacenaje

KC-221 AB06001

EMPAQUE	PZAS.	PESO	GARANTÍA
Caja Color	6	0.7 Kg	6 meses





desde 1960

Kits para Ciclista / BICYCLE TOOL KITS

Multiherramienta

Multitool
30 en 1



- INCLUYE:**
- Funda de nylon
 - Pegamento para chaucho
 - Raspador para goma
 - Barra para desmontar llanta
 - Juego de parches
 - Llaves allen 2/2.5/3/4/5/6 mm
 - Llaves 9/10/12/13/15 mm
 - Desarmador plano
 - Desarmador de cruz
 - Llave hexagonal tipo socket 8 mm
 - Navaja.

KC-301 AB06006

EMPAQUE	PZAS.	PESO	GARANTÍA
Blister	1 / 30	0.3 Kg	6 meses

Multiherramienta

Multitool
15 en 1



- INCLUYE:**
- Funda de nylon
 - Adaptador 1/4"
 - Dado a 8/9/10 mm
 - Llaves allen 2/2.5/3/4/5/6 mm
 - Llaves 8/10/15 mm
 - Desarmador plano
 - Desarmador de cruz
 - Llave 14 GE

MHC-151 AB06008

EMPAQUE	PZAS.	PESO	GARANTÍA
Blister	1 / 30	0.3 Kg	6 meses

Multiherramienta

Multitool
17 en 1



- INCLUYE:**
- Funda de nylon
 - Extractor de cadena
 - Llaves allen 2.5/3/4/5/6 mm
 - Llaves estriadas 8/9/10 mm
 - Destapador/Desarmador plano
 - Desarmador de cruz
 - Llave hexagonal tipo socket 8mm
 - Navaja

MHC-171 AB06007

EMPAQUE	PZAS.	PESO	GARANTÍA
Blister	1 / 48	0.2 Kg	6 meses

Linternas para ciclismo / BICYCLE RACKS

NEW LINE!

Linterna Plástica Trasera

Rear LED light
9 LEDS



LTB-09 AB12002

EMPAQUE	PZAS.	PESO	GARANTÍA
Blister	6/36	0.1 Kg	6 meses

Linterna delantera de aluminio de alta luminosidad

High intensity aluminum flash light

1 LED

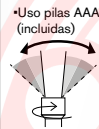

Haz de luz ajustable

LDB-01 AB12001

EMPAQUE	PZAS.	PESO	GARANTÍA
Blister	4/24	0.1 Kg	6 meses

Linternas plásticas juego de 4 leds

4 LED lamp set
4 LED



SEDT-2 AB12005

EMPAQUE	PZAS.	PESO	GARANTÍA
Blister	6/36	0.1 Kg	6 meses

Linterna juego (delantera y trasera)

Front and rear lamp set
9 LED / 1 LED



SLDT-2 AB12003

EMPAQUE	PZAS.	PESO	GARANTÍA
Blister	4/24	9.2 Kg	6 meses

Linterna lámpara tipo clip para calzado

Shoe Light Clip
2 LED



Haz de luz ajustable

CLC-02 AB12004

EMPAQUE	PZAS.	PESO	GARANTÍA
Blister	6/36	0.1 Kg	6 meses



- Ideal para
- Ciclismo y Atletismo
 - Iluminación fija - intermitente
 - 10 hrs de iluminación
 - Uso pilas tipo reloj (incluidas)

Colocación en talón de calzado

Estuche de celular para bicicleta

Bicycle Cellular phone Case

IMPERMEABLE

Bolsa porta smartphone

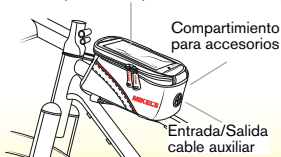

EBC-6 AB18001

EMPAQUE	PZAS.	PESO	GARANTÍA
Caja color	10/60	0.5 Kg	6 meses



•Ideal para dispositivos móviles de hasta 6"

•Pantalla touch de alta sensibilidad

Soporte de celular para bicicleta

Bicycle Cellular phone Holder

Multiposición 360°

- Ideal para todos los smartphones
- Brazos ajustables apertura máxima 10 cm
- Red de silicón para máximo agarre

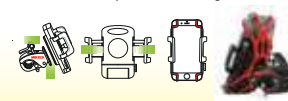

SBC AB18003

EMPAQUE	PZAS.	PESO	GARANTÍA
Caja color	10/60	0.5 Kg	6 meses





Racks para bicicletas / BICYCLE RACKS

Para 3 Bicicletas

For three bicycles

37 kg

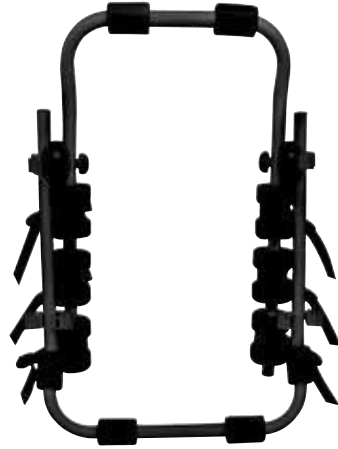

RBMC-03 AB02002

EMPAQUE	PZAS.	PESO	GARANTÍA
Caja Color	1	1.8 Kg	6 meses

Soporte para bicicletas de aluminio montaje en toldo

Roof top bike carrier



SBTA-60 AB02005

EMPAQUE	PZAS.	PESO	GARANTÍA
Blisters	3	11 Kg	1 año

Para 2 Bicicletas montaje en tirón 2"

Bike Hitch Rack 2 bikes

30 kg



Reforzado

Adaptable



RBMT-02 AB02003

EMPAQUE	PZAS.	PESO	GARANTÍA
Caja Color	1	7.5 Kg	6 meses

De pared para almacenaje 2 bicicletas

Bike storage rack 2 bikes

50 kg



Para 4 bicicletas montaje en tirón 2"

Bike Hitch Rack

60 kg



Reforzado

Adaptable



RBMT-04 AB02004

EMPAQUE	PZAS.	PESO	GARANTÍA
Caja Color	1	7.5 Kg	6 meses

RPAB-50 AB02006

EMPAQUE	PZAS.	PESO	GARANTÍA
Caja Color	2	23 Kg	1 año



Cables Candado y Candados de Seguridad / SECURITY CABLES AND PADLOCKS

Flexible 2 llaves planas, para niña

Girl's Cable Padlocks-2 Security Keys

65 cm Ø=12 mm

Incluye:
•2 llaves



CCR-65 AB10004

EMPAQUE	PZAS.	PESO	GARANTÍA
Blister	20 / 60	0.3 Kg	1 año

Flexible 2 llaves planas, para niño

Boy's Cable Padlocks-2 Security Keys

65 cm Ø=12 mm

Incluye:
•2 llaves



CCA-65 AB10003

EMPAQUE	PZAS.	PESO	GARANTÍA
Blister	20 / 60	0.3 Kg	1 año

Candado rígido de acero tipo U

U-type rigid steel padlock

2 llaves de seguridad

Soporte para bicicletas



C-1824 AC240001

EMPAQUE	PZAS.	PESO	GARANTÍA
Blister	1	0.9 Kg	1 año

Flexible de combinación 4 dígitos

Combination cable padlock

**65 cm
Ø=10 mm**



CB-65 AB10001

EMPAQUE	PZAS.	PESO	GARANTÍA
Blister	6	0.2 Kg	1 año

Cable candado en espiral

Cable Lock

**80 cm
Ø=6 mm**

Incluye:
•2 llaves



CCE-68 AE10007

EMPAQUE	PZAS.	PESO	GARANTÍA
Blister	10 / 100	0.1 Kg	1 año

De espiral retráctil con combinación 4 dígitos

Retractable spire cable padlock with combination

**1m
Ø=10mm**

Incluye:
•Soporte para bicicleta



CBE-100 AB10002

EMPAQUE	PZAS.	PESO	GARANTÍA
Blister	6	0.2 Kg	1 año

Plegable con combinación

Articulated foldable lock with key

**75 cm
Incluye:
•2 llaves**



CRA-75C AE10026

EMPAQUE	PZAS.	PESO	GARANTÍA
Blister	12	1.1 Kg	1 año

Plegable con llave de seguridad

Articulated foldable lock with combination

**75 cm
Incluye:
•2 llaves**



CRA-75L AE10025

EMPAQUE	PZAS.	PESO	GARANTÍA
Blister	12	1.2 Kg	1 año

Articulado para bicicleta

Articulated foldable lock for bicycle

**60 cm
Incluye:
•2 llaves**



CRA-60L AE10027

EMPAQUE	PZAS.	PESO	GARANTÍA
Blister	12	3 Kg	1 año



SUMINISTROS
INDUSTRIALES
DÍAZ

MIKEL'S



Línea Motociclismo



7821606595
7821604051
7821610766



contacto@sidad.com



www.sidad.com





desde 1960 **Equipos para Motocicleta / MOTORCYCLE EQUIPMENT**

Soporte universal para motocicleta

Motorcycle stand

340 kg

Altura regulable 3 diferentes posiciones Ideal para cambios de aceite, de llanta y cadena

- Altura mínima: 340 mm
- Altura máxima: 410 mm



SUM-340 AC24012

EMPAQUE	PZAS.	PESO	GARANTÍA
Caja	1	6 Kg	1 año

Pedestal Elevador para Motocicleta

Motorcycle padock stand

130 kg



PEM-130 AC24031

EMPAQUE	PZAS.	PESO	GARANTÍA
Caja Color	1	5.5 Kg	1 año

Plataforma hidráulica para motocicleta

Hdraulic motorcycle ramp

350 kg

Ascenso y descenso hidráulico de fácil acción por medio de pedal. Incluye ruedas para fácil transporte. Plataforma ideal para motos ligeras, scooters, motonetas, etc.



- Altura mínima: 23.5 cm
- Altura máxima: 74 cm

PHM-1 AC24010

EMPAQUE	PZAS.	PESO	GARANTÍA
Caja de Madera	1	104 Kg	1 año

Gato para motocicleta y cuatrimotos

Motorcycle and ATV jack

680 kg

Tiene ruedas giratorias traseras de 360° para fácil movilidad. Ascensor hidráulico, operado con pedal, para levantar la carga con 6 posiciones y freno de seguridad

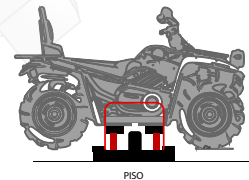

GB-680 AC24008

EMPAQUE	PZAS.	PESO	GARANTÍA
Caja	1	37.2 Kg	1 año

Plataforma hidráulica para motocicleta heavy duty

Heavy duty motorcycle ramp

500 kg

Diseño de rampa extra larga para motocicletas grandes. Ascenso y descenso hidráulico de fácil acción por medio de pedal. Incluye ruedas para fácil transporte y freno de seguridad.

- Altura mínima: 23.5 cm
- Altura máxima: 74 cm



PM-500 AC24011

EMPAQUE	PZAS.	PESO	GARANTÍA
Caja de Madera	1	174 Kg	1 año





Equipos para Motocicleta / MOTORCYCLE EQUIPMENT

Dolly para Motocicleta

Dolly Motorcycle

300 kg

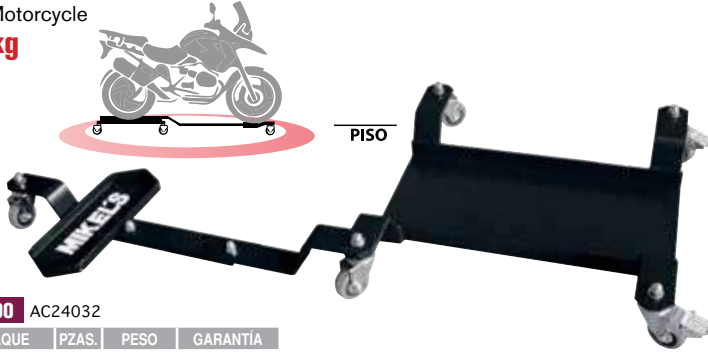

DM-300 AC24032

EMPAQUE	PZAS.	PESO	GARANTÍA
Caja Color	1	9.5 Kg	1 año

Cables pasa corriente para motociclismo

Motorcycle booster cables

Calibre 10
12 V

- Acabado Cobre
- Cable Duplex

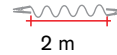

2 m

C-200-10M AC03001

EMPAQUE	PZAS.	PESO	GARANTÍA
Estuche	6/24	0.7 Kg	1 año

NEW!

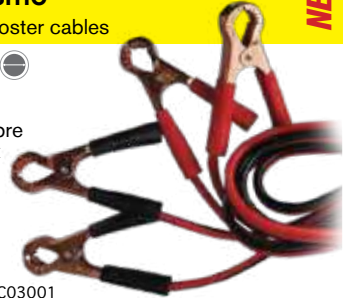

Dolly para Motocicleta

Dolly Motorcycle

500 kg

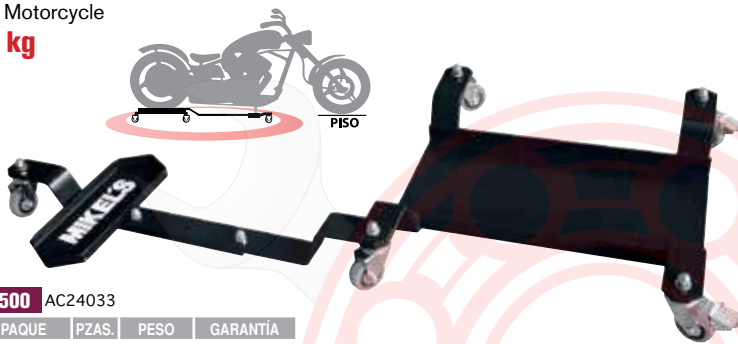

DM-500 AC24033

EMPAQUE	PZAS.	PESO	GARANTÍA
Caja	1	16 Kg	1 año

Estuche de celular para motocicleta

Motorcycle Cellular phone Case

IMPERMEABLE

- Para smartphones de hasta 6"
- Pantalla táctil alta sensibilidad



EMC-6 AB18002

EMPAQUE	PZAS.	PESO	GARANTÍA
Caja Color	10/60	0.5 Kg	6 meses

NEW!

Kits de Reparación / REPAIRATION TOOLS

Kit de reparación para llantas de moto

Reparation kit

Incluye:

- 3 tanques
- Protección térmica
- 10 Parches String
- Pegamento
- Válvula
- Navaja
- Pinza
- Broca
- Estuche



KMR AC24019

EMPAQUE	PZAS.	PESO	GARANTÍA
Blisters	5/20	0.6Kg	N/A

Parches para llantas de moto

Replace part Ruber

Incluye:

- Parches String
- Pegamento



PAMT AC24021

EMPAQUE	PZAS.	PESO	GARANTÍA
Blisters	20/120	0.05 Kg	N/A

Repuestos kit moto

Motorcycle Replace Parts

3 Tanques CO₂

Desechables



RKM AC24020

EMPAQUE	PZAS.	PESO	GARANTÍA
Blisters	20/80	0.2Kg	N/A





desde 1960

Accesorios para Motocicleta / MOTORCYCLE ACCESSORIES

Espejos Retrovisores Universales para Moto

UNIVERSAL REAR MIRROR

Rectangulares Negros

Black Rectangular



EURM-N	AC24034		
EMPAQUE	PZAS.	PESO	GARANTÍA
Blister	40	0.6 Kg	3 meses

Rectangulares Rojos

Red Rectangular



EURM-R	AC24035		
EMPAQUE	PZAS.	PESO	GARANTÍA
Blister	40	0.6 Kg	3 meses

Rectangulares Plata

Silver Rectangular



EURM-P	AC24036		
EMPAQUE	PZAS.	PESO	GARANTÍA
Blister	40	0.6 Kg	3 meses

Triangulares Negros

Black Triangular



EURM-2N	AC24042		
EMPAQUE	PZAS.	PESO	GARANTÍA
Blister	40	0.6 Kg	3 meses

Triangulares Rojos

Red Triangular



EURM-2R	AC24044		
EMPAQUE	PZAS.	PESO	GARANTÍA
Blister	40	0.6 Kg	3 meses

Triangulares Plata

Silver Triangular



EURM-2P	AC24043		
EMPAQUE	PZAS.	PESO	GARANTÍA
Blister	40	0.6 Kg	3 meses

Puños para motocicleta

BLACK UNIVERSAL HAND GRIP

Negro

Black



PUMO-N	AC24038		
EMPAQUE	PZAS.	PESO	GARANTÍA
Blister	50	0.1 Kg	3 meses

Plata

Silver



PUMO-P	AC24040		
EMPAQUE	PZAS.	PESO	GARANTÍA
Blister	50	0.1 Kg	3 meses

Rojo

Red



PUMO-R	AC24039		
EMPAQUE	PZAS.	PESO	GARANTÍA
Blister	50	0.1 Kg	3 meses





Accesorios para Motocicleta / MOTORCYCLE ACCESSORIES

Alforjas semi rígidas

Saddle bag

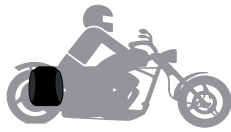

AFS-34 AC24028

EMPAQUE	PZAS.	PESO	GARANTÍA
Caja Color	4	3 Kg	6 meses

Maleta para tanque de gasolina sujeción magnética

Tank bag



MTG AC24027

EMPAQUE	PZAS.	PESO	GARANTÍA
Caja Color	4	2.2 Kg	6 meses

Mochila multiusos para motociclismo

Backpack



BPM AC24029

EMPAQUE	PZAS.	PESO	GARANTÍA
Caja Color	4	1.7 Kg	6 meses

Guante pro con refuerzos de seguridad

High security professional glove

Medianos

GPRS-M AC24022

EMPAQUE	PZAS.	PESO	GARANTÍA
Caballette	100	0.2 kg	6 meses

Largos

GPRS-L AE06052

EMPAQUE	PZAS.	PESO	GARANTÍA
Caballette	100	0.2 kg	6 meses

Extra Largos

GPRS-XL AE06053

EMPAQUE	PZAS.	PESO	GARANTÍA
Caballette	100	0.2 kg	6 meses



Paquete caja para moto, guantes e impermeable

Motorcycle kit, Gloves, rain coat and case

31 Litros



PKM-31 AC24025

EMPAQUE	PZAS.	PESO	GARANTÍA
Caja Color	1 / 4	4.7 Kg	1 año

Impermeable y guantes unitalla

Paquete caja para moto, guantes y casco

Motorcycle kit, Gloves, helmet and case

42 Litros



PKM-42 AC24024

EMPAQUE	PZAS.	PESO	GARANTÍA
Caja Color	1	6.6 Kg	1 año

Casco y guantes unitalla

Cubierta para motocicleta chica

Small motorcycle covers

240 x 53 x 150 cm



CUM-1 AC24006

EMPAQUE	PZAS.	PESO	GARANTÍA
Caja Color	1	0.6 Kg	3 meses

Cubierta para motocicleta grande

Large motorcycle covers

219 x 42.7 x 127.5 cm



CUM-2 AC24007

EMPAQUE	PZAS.	PESO	GARANTÍA
Caja Color	1	0.7 Kg	3 meses





desde 1960

Accesorios para Motocicleta / MOTORCYCLE ACCESSORIES

Ganchos tensores 2 piezas

2 Pieces tie downs

1"
545 kg
1.8 m

Acero templado de 8mm
con recubrimiento de vinil



T-2 AA13006

EMPAQUE	PZAS.	PESO	GARANTÍA
Blisters	20	0.8 Kg	6 meses

Ganchos tensores 4 piezas

4 Pieces tie downs

1"
1 t
1.8 m



T-3 AA13007

EMPAQUE	PZAS.	PESO	GARANTÍA
Blisters	5	1.8 Kg	6 meses

Ganchos tensores con matraca 4 piezas

Tie downs with ratchet
straps 4 piezas

1"
450 kg
4.5 m



T-3M AA13008

EMPAQUE	PZAS.	PESO	GARANTÍA
Blisters	5	2.1Kg	6 meses

Bungees cinturones elásticos

Elastic belts bungees

6 piezas

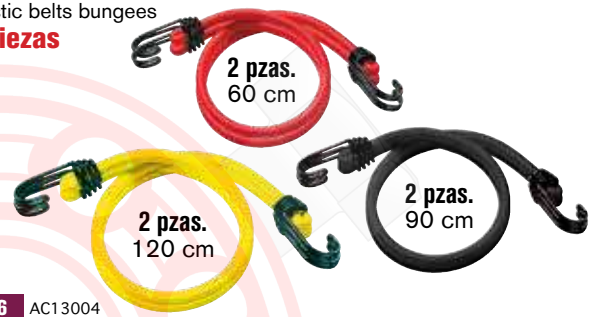

BU-6 AC13004

EMPAQUE	PZAS.	PESO	GARANTÍA
Bolsa Colgador	12	0.1 Kg	6 meses

Bungees cinturones elásticos

Elastic belts bungees

8 piezas



BU-8 AC13001

EMPAQUE	PZAS.	PESO	GARANTÍA
Bote de Plástico	20 / 60	0.6 Kg	6 meses

Incluye bote de plástico
Includes plastic case

Redes de carga

Cargo nets

30 x 30 cm

6 ganchos metálicos

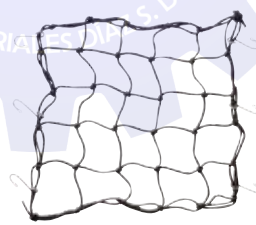

RC-6 AC13003

EMPAQUE	PZAS.	PESO	GARANTÍA
Blisters	60	0.1 Kg	6 meses

90 x 150 cm

12 ganchos metálicos

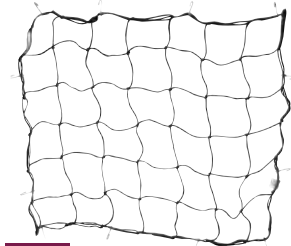

RC-12 AC13004

EMPAQUE	PZAS.	PESO	GARANTÍA
Blisters	24	0.5 Kg	6 meses

Candados para freno de disco

Disk brake lock

Chico

Incluye cable
para recordar
que el candado
está instalado



Ideal para motocicletas scooters
Vástago de 5.5 mm de grosor

CFD-05 AC24002

EMPAQUE	PZAS.	PESO	GARANTÍA
Blisters	6 / 24	0.3 Kg	1 año

Candados para freno de disco

Disk brake lock

Grande

Incluye cable
para recordar
que el candado
está instalado



Ideal para motocicletas grandes y medianas.
Vástago de 10 mm de grosor

CFD-10 AC24003

EMPAQUE	PZAS.	PESO	GARANTÍA
Blisters	6 / 24	0.6 Kg	1 año





MIKEL'S

Línea
Eléctrico



MIKEL'S





desde 1960 **Arrancadores de Baterías Jumper / QUICK JUMPER**

Jumper

Jump Starter
8,000 mAh

Carga teléfonos móviles, tabletas u otros dispositivos electrónicos con carga vía USB

- Incluye:
- Estuche
 - Pinzas inteligentes
 - Accesorios



**PARA AUTOS
4 CILINDROS**

MJS-8000	AA02108		
EMPAQUE	PZAS.	PESO	GARANTÍA
Caja Color	1 / 10	0.8 Kg	1 año

Jumper

Jump Starter
12,000 mAh

Carga teléfonos móviles, tabletas u otros dispositivos electrónicos con carga vía USB

- Incluye:
- Estuche
 - Pinzas inteligentes
 - Accesorios



**PARA AUTOS
6 Y 8 CILINDROS**

MJS-12000	AA02096		
EMPAQUE	PZAS.	PESO	GARANTÍA
Caja Color	1 / 10	1 Kg	1 año

Jumper

Jump Starter
**3 en 1
350 A**

- Arrancador de motores
- Entrada USB
- Toma de corriente para accesorios 12 V



BAT-100	AD08013		
EMPAQUE	PZAS.	PESO	GARANTÍA
Caja Color	4	3.6 Kg	3 meses

Jumper

Jump Starter
900 A

- Arrancador de motores
- Entrada USB
- Toma de corriente para accesorios 12 V
- Luz de emergencia



BAT-120R	AD08001		
EMPAQUE	PZAS.	PESO	GARANTÍA
Caja Color	2	7.2 Kg	3 meses

Aspiradora sólidos y líquidos

Vacuumm for solid and liquids
25 Its

Tanque de plástico
Manguera de 1.5 m



ASL-25	AD04033		
EMPAQUE	PZAS.	PESO	GARANTÍA
CAJA	1	9 Kg	1 año

Esmeriles de banco / BENCH GRINDERS

5"
1/3 HP
3,450 RPM
150 W



ED-5	AD04010		
EMPAQUE	PZAS.	PESO	GARANTÍA
Caja Color	1	4.7 Kg	1 año

6"
1/2 HP
3,450 RPM
250 W



ED-6	AD04011		
EMPAQUE	PZAS.	PESO	GARANTÍA
Caja Color	1	7 Kg	1 año

8"
3/4 HP
3,450 RPM
400 W



ED-8	AD04012		
EMPAQUE	PZAS.	PESO	GARANTÍA
Caja Color	1	10.6 Kg	1 año





Cargadores de Baterías / BATTERY CHARGERS

Automático

Automatic
1.5 Amp
12 V



CBA-1.5 AD08004

EMPAQUE	PZAS.	PESO	GARANTÍA	CONEXIÓN
Blister	4	0.4 Kg	1 año	Contacto

Automático con arrancador

Automatic w / engine starter
2 / 10 / 50 Amp
12 V

Medidor de nivel de carga, leds indicadores de carga completa y encendido.



CBAA-50 AD08006

EMPAQUE	PZAS.	PESO	GARANTÍA	CONEXIÓN
Caja Color	2	4.8 Kg	1 año	Contacto

Cargador de baterías

Battery charger
2 / 15 / 100 Amp

- Automático controlado por microprocesador
- Programa de 6 etapas de carga



CBA-100 AD08017

EMPAQUE	PZAS.	PESO	GARANTÍA	CONEXIÓN
Caja Color	2	4.6 Kg	1 año	Contacto

Probador de baterías

Battery tester
100 Amp



PBA-100 AD08009

EMPAQUE	PZAS.	PESO	GARANTÍA
Caja Color	1 / 3	1.3 Kg	1 año

Con arrancador

Charger
2 / 35 / 200 Amp
12 V

Transformador HD que ahorra energía
Devanado de cobre y láminas de acero.



CBA-200 AD08005

EMPAQUE	PZAS.	PESO	GARANTÍA
Caja Color	1	14.4 Kg	1 año

Con arrancador, probador y amperímetro

Charger with engine starter, tester and amperimeter
2 / 10 / 50 / 125 / 225 Amp
6 y 12 V



CBAP-225 AD08007

EMPAQUE	PZAS.	PESO	GARANTÍA
Caja Color	1	14.5 Kg	1 año





desde 1960 Cabezales para compresores de aire / COMPRESSOR HEADS

3/4 HP

3.9 CFM
1 Cilindro de 65mm
1,430 RPM



CPC-3/4 AD35003

EMPAQUE	PZAS.	PESO	GARANTÍA
Caja	1	8.4 Kg	1 año

1 HP

6.7 CFM
2 Cilindros de 51mm
1,000 RPM



CPC-1 AD35001

EMPAQUE	PZAS.	PESO	GARANTÍA
Caja	1	13.5 Kg	1 año

2 HP

8.2 CFM
2 Cilindros de 51mm
1,270 RPM



CPC-2 AD35002

EMPAQUE	PZAS.	PESO	GARANTÍA
Caja	1	16.2 Kg	1 año

5 HP

22.4 CFM
2 Cilindros de 65mm
1,050 RPM



CPC-5 AD35004

EMPAQUE	PZAS.	PESO	GARANTÍA
Caja	1	33.9 Kg	1 año

5 HP

2 etapas
22 CFM
810 RPM
2 PISTONES



CPC-52E AD35005

EMPAQUE	PZAS.	PESO	GARANTÍA
Caja	1	50 Kg	1 año

10 HP

2 etapas
41 CFM
810 RPM
4 PISTONES



CPC-10HP AD35006

EMPAQUE	PZAS.	PESO	GARANTÍA
Caja Madera	1	100 Kg	1 año

NEW!

Compresores de Aire /AIR COMPRESSORS

Tipo Hamburguesa

1/2 HP
11 lts
110 V
60 Hz
100 PSI
3400 RPM

LIBRE DE ACEITE

Incluye:
• 7 accesorios neumáticos



CA-1/2HP AD04029

EMPAQUE	PZAS.	PESO	GARANTÍA	CONEXIÓN
Caja Color	1	9.7 Kg	1 año	Contacto

1 HP

10 lts
110 V
60 Hz
560 W
115 PSI
3400 RPM

Incluye:
• 19 accesorios neumáticos



CA-75HP AD04008

EMPAQUE	PZAS.	PESO	GARANTÍA	CONEXIÓN
Caja Color	1	16.6 Kg	6 meses	Contacto





Compresores de Aire /AIR COMPRESSORS

1.5 HP
12 lts
110 V
110 W
110 PSI
3400 RPM



Incluye:
•19 accesorios neumáticos



CA-1.5HP AD04003

EMPAQUE	PZAS.	PESO	GARANTÍA	CONEXIÓN
Caja Color	1	17.8 Kg	6 meses	Contacto

1.5 HP
24 lts
110 V
1119 W
115 PSI
3400 RPM



LIBRE DE ACEITE

CALA-1.5 AD04032

EMPAQUE	PZAS.	PESO	GARANTÍA	CONEXIÓN
Caja Color	1	10 Kg	1 año	Contacto

2 HP
24 lts
110 V
1500 W
110 PSI
3400 RPM



CA-2HP AD04004

EMPAQUE	PZAS.	PESO	GARANTÍA	CONEXIÓN
Caja Color	1	23.7 Kg	6 meses	Contacto

2.5 HP
50 lts
110 V
1600 W
110 PSI
3400 RPM



LIBRE DE ACEITE

CALA-2.5HP AD04030

EMPAQUE	PZAS.	PESO	GARANTÍA	CONEXIÓN
Caja Color	1	36.5 Kg	6 meses	Contacto

3 HP
50 lts
110 V
1700 W
110 PSI
3400 RPM



CA-3HP AD04005

EMPAQUE	PZAS.	PESO	GARANTÍA	CONEXIÓN
Caja Color	1	31.5 Kg	6 meses	Contacto

Sistema de banda de larga vida

Belt driven motor

3 HP
60 lts
110 V
2230 W
110 PSI
1270 RPM



CA-3HP60 AD04006

EMPAQUE	PZAS.	PESO	GARANTÍA	CONEXIÓN
Caja Color	1	66 Kg	6 meses	Contacto

mikels.com.mx | @mikels tools





desde 1960

Compresores de Aire /AIR COMPRESSORS

A Gasolina

Gasoline
5.5 HP
60 lts
250 l / min
1200 RPM



- Motor de combustión Interna
- Flujo 250 L/min
- 882 CFM
- Presión de trabajo 110 Psi
- Sistema de ahorro de combustible
- Arranque Manual

CG-5.5HP AD07014

EMPAQUE	PZAS.	PESO	GARANTÍA
Caja	1	80 Kg	6 meses

A Gasolina, arranque automático

Gasoline
13 HP
300 lts
530 l / min
1200 RPM



Opera con Gasolina Magna y/o Premium

- Motor de combustión Interna 13 HP
- Flujo 530 L/min
- Presión de trabajo 120 Psi
- Sistema de ahorro de combustible
- Arranque Manual y Automático

CG-13HP AD07013

EMPAQUE	PZAS.	PESO	GARANTÍA
Caja	1	200 Kg	1 año

VERTICAL Sistema de banda de larga vida

Belt driven motor
5 HP
190 lts
110 V
60 Hz
2200 W
110 PSI
1200 RPM



CA-5HP AD04007

EMPAQUE	PZAS.	PESO	GARANTÍA	CONEXIÓN
Caja Madera	1	124 Kg	6 meses	Contacto

Compresor trifásico

5 HP
300 lts
220 V Trifásico
150 PSI
810 RPM



CAT-5HP AD04034

EMPAQUE	PZAS.	PESO	GARANTÍA	CONEXIÓN
Caja de Madera	1	200 Kg	1 año	Contacto

- Flujo 624 L/min
- 22 CFM
- Arranque termo magnético

Compresor trifásico

500 lts
220V trifásico
7457 W
175 PSI
800 RPM

- Cabezal 2 etapas
- Flujo 1156L/min
- 41 CFM
- Arranque termo magnético



CAT-10HP AD04035

EMPAQUE	PZAS.	PESO	GARANTÍA	CONEXIÓN
Caja de Madera	1	300 Kg	1 año	Contacto





Hidrolavadoras de Alta Presión Eléctricas / ELECTRIC PRESSURE WASHERS

Motor de carbones

Carbon brush motor

1500 PSI
103 Bar

Incluye:

- Pistola y bayoneta
- Botella para jabón
- Conexión rápida para manguera

Longitud de cable eléctrico **5 m**

Longitud de manguera **5 m**

Presión máxima: **1500 PSI**

Presión de trabajo: **1350 PSI**



LP-70T BD04001

EMPAQUE	PZAS.	PESO	GARANTÍA	CONEXIÓN
Caja Color	1	6.5 Kg	6 meses	Contacto

Motor de carbones

Carbon brush motor

1500 PSI
103 Bar

Incluye:

- Filtro externo
- Pistola y bayoneta
- Botella para jabón
- Conexión rápida para manguera

Longitud de cable eléctrico **5 m**

Longitud de manguera **5 m**

Presión máxima: **1500 PSI**

Presión de trabajo: **1350 PSI**



LP-70R AD04013

EMPAQUE	PZAS.	PESO	GARANTÍA	CONEXIÓN
Caja Color	1	7.5 Kg	6 meses	Contacto



Filtro

Semiprofesional, motor de inducción

Semi pro

1900 PSI
130 Bar

Incluye:

- Filtro de agua externo
- Pistola y bayoneta
- Depósito para jabón
- Conexión rápida para manguera

• Longitud de cable eléctrico **5 m**

• Longitud de manguera **5 m**

• Presión máxima: **1900 PSI**

• Presión de trabajo: **1750 PSI**



Filtro

LP-90R AD04014

EMPAQUE	PZAS.	PESO	GARANTÍA	CONEXIÓN
Caja Color	1	15 Kg	1 año	Contacto

Motor de inducción

Induction motor

2300 PSI
158 Bar

Incluye:

- Filtro de agua externo
- Pistola y bayoneta
- Depósito para jabón
- Cepillo giratorio
- Conexión rápida para manguera

• Longitud de cable eléctrico **5 m**

• Longitud de manguera **5 m**

• Presión máxima: **2300 PSI**

• Presión de trabajo: **2000 PSI**



Filtro

LPC-1750 AD04024

EMPAQUE	PZAS.	PESO	GARANTÍA	CONEXIÓN
Caja Color	1	20 Kg	1 año	Contacto

Industrial

1500 PSI
220V
2 HP
103 Bar

Incluye:

- Filtro de agua externo
- Pistola con empuñadora ergonómica
- Boquillas con distintos ángulos de aspersión

• Longitud de cable eléctrico **5 m**

• Longitud de manguera **8 m**

• Presión máxima: **1500 PSI**

• Presión de trabajo: **1350 PSI**

• Motor 2 fases



LPI-2HP AD04016

EMPAQUE	PZAS.	PESO	GARANTÍA	CONEXIÓN
Caja Color	1	33 Kg	1 año	Contacto

Industrial



Incluye:

- Pistola de lavado
- Boquillas con distintos ángulos de aspersión
- Longitud de cable **5 m**
- Longitud de manguera **10 m**
- Presión máxima: **2900 PSI**
- Presión de trabajo: **2700 PSI**
- Motor 3 fases

MEJORADO

2900 PSI
220V
7.5 HP
200 Bar

LPI-7HP AD04017

EMPAQUE	PZAS.	PESO	GARANTÍA
Caja	1	55 Kg	1 año





desde 1960

Equipos de Combustión / INTERNAL COMBUSTION EQUIPMENTS

Hidrolavadora de alta presión a gasolina motor 4 tiempos

Pressure washer 4-stroke motor



- Incluye:
- Pistola, bayoneta y boquillas
 - Capacidad del tanque de gasolina **1.7 lts**
 - Longitud de manguera **6.5 m**
 - Presión máxima: **2000 PSI**
 - Presión de trabajo: **1850 PSI**

2000 PSI
3.0 HP
137 Bar

HAG-2100 AD07007

EMPAQUE	PZAS.	PESO	GARANTÍA
Caja Color	1	32 Kg	1 año

Hidrolavadora de alta presión a gasolina motor 4 tiempos

Pressure washer 4-stroke motor



- Incluye:
- Pistola, bayoneta y boquillas
 - Capacidad del tanque de gasolina **3.6 lts**
 - Longitud de manguera **8 m**
 - Presión máxima: **2700 PSI**
 - Presión de trabajo: **2400 PSI**

2700 PSI
6.5 HP
186 Bar

HAG-2500 AD07008

EMPAQUE	PZAS.	PESO	GARANTÍA
Caja Color	1	34 Kg	1 año

Hidrolavadora de alta presión a gasolina motor a 4 tiempos

Pressure washer 4-stroke motor

NEW!



- Incluye:
- Pistola, bayoneta y boquillas
 - Capacidad del tanque de gasolina **3.6 lts**
 - Longitud de manguera **8 m**
 - Presión máxima: **3100 PSI**
 - Presión de trabajo: **2900 PSI**

3100 PSI
7.5 HP
213 Bar

HAG-3100 AD07017

EMPAQUE	PZAS.	PESO	GARANTÍA
Caja	1	90 Kg	1 año

Motobomba para agua a gasolina motor 4 tiempos

Water pumps 4-stroke motor

USO AGRÍCOLA

2"
5.5 HP
4000 RPM

- Capacidad / Capacity: 600 l x min
- Dimensiones / Dimensions: 40cm x 43 cm x 45cm



IMPORTANTE:
Se recomienda utilizar filtro en la entrada

MAG-2 AD07015

EMPAQUE	PZAS.	PESO	GARANTÍA
Caja	1	23 Kg	1 año

Motobomba para agua a gasolina motor 4 tiempos

Water pumps 4-stroke motor

USO AGRÍCOLA

3"
6.5 HP
4000 RPM

- Capacidad / Capacity: 1000 l x min
- Dimensiones / Dimensions: 50cm x 43 cm x 45cm



IMPORTANTE:
Se recomienda utilizar filtro en la entrada

MAG-3 AD07016

EMPAQUE	PZAS.	PESO	GARANTÍA
Caja	1	25 Kg	1 año

MODELO / MODEL	LP-70R	LP-70T	LP-90R	LPC-1750	LPI-2HP	HAG-2100	HAG-2500	LPI-7HP	
Voltaje de Red / Power Supply Voltage	V	120	120	120	220	---	---	220	
Frecuencia de Red / Power Frequency	Hz	60	60	60	60	---	---	60	
Potencia de Entrada / Input Power	W	1,500	1,500	1,400	1,500	---	---	4,000	
Presión de Funcionamiento / Operating Pressure	lb x Pulg ²	1,350 - 1,900	1,350 - 1,900	1,350 - 1,950	1,500 - 2,300	1,500 - 1,750	1,800 - 2,300	2,000 - 2,500	2,900 - 3,350
Velocidad del Motor / Engine Speed	RPM	1,500	1,500	1,500	1,500	1,450	3,600	6,500	1,700
Consumo de Agua / Water flow per minute	litros/min	5.7	5.7	6.0	6.0	7.7	6.0	11.0	12.5
Temp. Máx. Funcionamiento / Max Operating Temp	°C	5 - 60	5 - 60	5 - 60	5 - 60	5 - 60	5 - 60	5 - 60	5 - 60
Presión de Trabajo/ Working Pressure	°C	1350	1350	1750	2000	1350	1850	2400	2465
Presión Máxima/ Maximum Pressure	°C	1500	1500	1900	2300	1500	2000	2700	2900





Equipos de Combustión / INTERNAL COMBUSTION EQUIPMENTS

Generador de corriente eléctrica motor 2 tiempos

Gasoline generators 2-stroke motor

800 W
2 HP
6.8 A
120 V
60 Hz

- Tanque 4 lts Monofásico
- Encendido manual o automático



GCE-800 AD07004

EMPAQUE	PZAS.	PESO	GARANTÍA
Caja Color	1	16.4 Kg	1 año

MONOFÁSICO

Generador de corriente eléctrica motor 4 tiempos

Gasoline generators 4-stroke motor

3000 W
6.5 HP
23 A
120 V
60 Hz

- Tanque 16 lts
- Monofásico
- Cuenta con asas e incluye 2 ruedas facilitando su rápido desplazamiento



GCE-2700 AD07002

EMPAQUE	PZAS.	PESO	GARANTÍA
Caja Color	1	48 Kg	1 año

MONOFÁSICO

Generador de corriente eléctrica motor 4 tiempos

Gasoline generators 4-stroke motor

5500 W
15 HP
40 A
120 V
60 Hz

- Tanque 25 lts
- Incluye:
Manubrio y ruedas



MEJORADO

GCE-5500 AD07003

EMPAQUE	PZAS.	PESO	GARANTÍA
Caja	1	91 Kg	1 año

MONOFÁSICO
BIFÁSICO

Generador de corriente eléctrica con soldadora motor 4 tiempos

Gasoline generators 4-stroke motor

5500 W
15 HP
40 A
120 V
60 Hz

- Tanque 25 lts
- Incluye:
Manubrio, ruedas, cables, pinzas de tierra y porta electrodo



MEJORADO

GCE-55 AD07006

EMPAQUE	PZAS.	PESO	GARANTÍA
Caja	1	90 Kg	1 año

MONOFÁSICO

Generador de corriente eléctrica motor 4 tiempos

Gasoline generators 4-stroke motor

8000 W
15 HP
25 A
60 Hz
120/220 V

- Tanque 25 lts
- Manubrio y ruedas



MEJORADO

GCE-8000 AD07005

EMPAQUE	PZAS.	PESO	GARANTÍA
Caja	1	95 Kg	1 año

MONOFÁSICO
BIFÁSICO

Generador de corriente eléctrica motor 4 tiempos

Gasoline generators 4-stroke motor

10000 W
16 HP
23 A
60 Hz
120/220 V

- Tanque 25 lts
- Manubrio y ruedas



MEJORADO

GCE-10000 AD07012

EMPAQUE	PZAS.	PESO	GARANTÍA
Caja	1	120 Kg	1 año

MONOFÁSICO
BIFÁSICO



Herramienta Eléctrica / ELECTRIC TOOLS

Carrete con extensión eléctrica

Electric cable reel

10 m

Calibre 16 AWG



CEE-10 AD04031

EMPAQUE	PZAS.	PESO	GARANTÍA	CONEXIÓN
Caja Color	1/4	3.1 Kg	1 año	Contacto

Pistola de impacto inalámbrica recargable

Cordless impact wrench

1/2"

Torque: 700 lb/ft

Batería Ion de litio



MEJORADO

PI-500 AD04025

EMPAQUE	PZAS.	PESO	GARANTÍA
Portafolio	1/2	6.7 Kg	1 año

Pistola de impacto eléctrica 3/4"

Electric impact wrench 3/4"

600 W

Torque: 700 lb/ft

Incluye:

- Dado de 30 mm
- Pasador de sujeción
- Anillos de goma
- Agarradera ajustable



NEW!

PIE-34 AD04037

EMPAQUE	PZAS.	PESO	GARANTÍA	CONEXIÓN
Portafolio	4	9 Kg	1 año	Contacto

Pistola de impacto eléctrica

Electric impact wrench

Torque: 700 lb/ft

Incluye:

- Dados de impacto: (17 mm, 19 mm, 21mm y 22 mm)
- Longitud de cable: 1.20 m

Incluye:

- Impact socket (17mm, 19mm, 21mm y 22mm)



PIE-900 AD04020

EMPAQUE	PZAS.	PESO	GARANTÍA	CONEXIÓN
Portafolio	1	5.75 Kg	1 año	Contacto

Pistola de Calor

Hot air gun

1500 W



Tamer

PC-1500T BD04002

EMPAQUE	PZAS.	PESO	GARANTÍA	CONEXIÓN
Caja Color	1/10	1.1 Kg	6 meses	Contacto

Pistola de Calor Uso Rudo

Heavy duty hot air gun

1500 W



PCM-1500 AD04020

EMPAQUE	PZAS.	PESO	GARANTÍA	CONEXIÓN
Portafolio	1/5	2 Kg	1 año	Contacto

Luminarios de Emergencia / EMERGENCY LAMP

Multifuncional 4 en 1

4 in 1 multifunction

21 focos tipo Led

Requiere 3 baterías "AA" (no incluidas)
Three "AAA" batteries required (not included)



LMF-4 AD12017

EMPAQUE	PZAS.	PESO	GARANTÍA
Blister	12	0.34 Kg	3 meses

Luminario Recargable

Multiusos

Multiple Use Rechargeable Lamp

30 focos tipo LED



LTF-CA AD12027

EMPAQUE	PZAS.	PESO	GARANTÍA
Caja Color	4	0.66 Kg	3 meses

Para mecánico recargable

Mechanic Emergency

27 focos tipo LED



LMR-27L AD12022

EMPAQUE	PZAS.	PESO	GARANTÍA
Blister	12	0.5 Kg	3 meses



Lámparas de LED / LED HAND LAMP

Recargable de plástico

Rechargeable plastic

3 LEDS
110 V



Clavija retráctil
incorporada

LMR-3L AD12023

EMPAQUE	PZAS.	PESO	GARANTÍA
Blister	6	0.2 Kg	3 meses

Tipo minero

Head lamp

LED
Batería



Incluye 3 baterías "AAA"

LTML-3AAA AD12028

EMPAQUE	PZAS.	PESO	GARANTÍA
Blister	12/72	0.13 Kg	3 meses

Recargable a prueba de agua CA / CD

Waterproof, rechargeable AC / DC

LED
110 V
1 MC



LMR-1M AD12021

EMPAQUE	PZAS.	PESO	GARANTÍA
Caja Color	12	1.35 Kg	1 año

Recargable

Rechargeable

4 LED
110 V



Clavija retráctil
incorporada

LMR-4L AD12024

EMPAQUE	PZAS.	PESO	GARANTÍA
Blister	40/80	0.14 Kg	3 meses

Recargable

Rechargeable

7 LED
110 V



Clavija retráctil
incorporada

LMR-7L AD12025

EMPAQUE	PZAS.	PESO	GARANTÍA
Blister	40/80	0.18 Kg	3 meses

Recargable

Rechargeable

15 LED
110 V



Clavija retráctil
incorporada

LMR-15L AD12026

EMPAQUE	PZAS.	PESO	GARANTÍA
Blister	12/24	0.33 Kg	3 meses

Recargable articulada

Rechargeable Flash light

LED
110 V
3W

Incluye:
•Power bank

Articula de
180° a 120°



LLT-3W AD12032

EMPAQUE	PZAS.	PESO	GARANTÍA
Blister	20	0.5 Kg	1 año

Recargable retráctil

Rechargeable Flash light

LED
110 V
5 W



LRRL-36 AD12030

EMPAQUE	PZAS.	PESO	GARANTÍA
Blister	1/12	0.56 Kg	1 año

De aluminio

Cast Aluminum w/LED

6"
LED
Baterías

Incluye:
•Baterías AAA

Includes battery AAA



MEJORADO

LDA-00 AD12006

EMPAQUE	PZAS.	PESO	GARANTÍA
Blister	10/40	0.13 Kg	3 meses

Recargable a prueba de agua CA / CD

Waterproof, rechargeable AC / DC

LED
12V
120 W
2.5 M

2.5 millones de candelas
2.5 million candle power

LHR-2.5M AD12014

EMPAQUE	PZAS.	PESO	GARANTÍA
Caja Color	8	2 Kg	1 año



Recargable

Head lamp

LED
110 V
5 W

6 millones de candelas
6 million candle power

LDR-5W AD12031

EMPAQUE	PZAS.	PESO	GARANTÍA
Caja Color	12	1.7 Kg	1 año



desde 1960

Lámparas de Halógeno / HALOGEN LAMP

Mini lámpara con imán
Mini lamp with magnet
12 V

Carrete integrado para almacenar el cable de 3 m de longitud



MLHI-12 AD12029

EMPAQUE	PZAS.	PESO	GARANTÍA	CONEXIÓN
Blister	50	0.2 Kg	3 meses	12 V

2 niveles de luminosidad 2 opciones de alimentación de poder: CA / CD
Recargable



3 millones de candelas
3 million candle power

LHR-3M AD12015

EMPAQUE	PZAS.	PESO	GARANTÍA	CONEXIÓN
Caja Color	4	2.6 Kg	3 meses	Contacto

2 niveles de luminosidad 2 opciones de alimentación de poder: CA / CD
Recargable



10 millones de candelas
10 million candle power

LHR-10M AD12016

EMPAQUE	PZAS.	PESO	GARANTÍA	CONEXIÓN
Caja Color	3	3 Kg	3 meses	Contacto

Lámparas Solares de Emergencia / RECHARGE SOLAR FLASHLIGHT

500 mAh
Luz LED



•300 lúmenes
•Celda solar integrada

LES-500 AD12033

EMPAQUE	PZAS.	PESO	GARANTÍA
Blister	6/48	0.25 Kg	6 meses

300 mAh
Luz LED



•350 lúmenes
•Celda solar integrada

LES-350 AD12034

EMPAQUE	PZAS.	PESO	GARANTÍA
Blister	6/48	0.25 Kg	6 meses

250 mAh
Luz LED



•250 lúmenes
•Celda solar integrada

LES-250 AD12035

EMPAQUE	PZAS.	PESO	GARANTÍA
Blister	6/48	0.2 Kg	6 meses

NEW!

Pulidoras Automotrices / AUTOMOTIVE POLISHERS

250 mAh
Doble Iluminación Luz LED

NEW!



•250 lúmenes
•Celda solar integrada

LESD-250 AD12036

EMPAQUE	PZAS.	PESO	GARANTÍA
Blister	6/48	0.2 Kg	6 meses

Automotriz heavy duty, velocidad variable

HD Automotive polisher

7"

3000 RPM

120 V / CA 60 Hz.
Diámetro del disco: 180 mm
Plate diameter: 180 mm



PA-7 AD04018

EMPAQUE	PZAS.	PESO	GARANTÍA	CONEXIÓN
Caja Color	4	3.9 Kg	1 año	Contacto

Orbital a dos manos

Super polisher

9"

3200 RPM

150 W 120 V / CA 60 Hz 1.2 A
Diámetro del disco: 241 mm
Plate diameter 241 mm



MEJORADO

SP-1 AD04023

EMPAQUE	PZAS.	PESO	GARANTÍA	CONEXIÓN
Caja Color	2	2.3 Kg	6 meses	Contacto

Orbital una mano

Orbital polisher

6"

3800 RPM

32 W 120 V / CA 60 Hz.
Diámetro del disco: 152 mm
Plate diameter: 152 mm



MEJORADO

POM-6 AD04021

EMPAQUE	PZAS.	PESO	GARANTÍA	CONEXIÓN
Blister	4	1.6 Kg	6 meses	Contacto



Multímetros / MULTIMETERS

Digital básico

Basic digital

Pantalla de cristal líquido
Lectura máxima 1999

Protección contra sobrecargas

Voltaje C.D.:
200mv / 2V / 20V / 200V / 600V

Voltaje C.A.:
200V / 750V

Corriente Directa C.D.:
20mA / 200mA / 10A

Resistencia:
200Ω / 2kΩ / 20kΩ / 200kΩ / 2MΩ / 20MΩ



MDB-830 AD28001

EMPAQUE	PZAS.	PESO	GARANTÍA
Caja Color	12/72	0.17 Kg	1 año

Digital de gancho

Hook type digital

Voltaje C.D.:
200mv / 2V / 20V / 200V / 600V

Voltaje C.A.:
2V / 20V / 200V / 600V

Corriente Alterna C.A.:
2A / 20A / 200A / 600A

Resistencia:
200Ω / 2kΩ / 20kΩ / 200kΩ / 2MΩ / 20MΩ

Temperatura:
-20°C hasta 750°C (-4°F to 1382°F)



MDG-465 AD28002

EMPAQUE	PZAS.	PESO	GARANTÍA
Caja Color	1/20	0.45 Kg	1 año



Digital automotriz

Automotive digital

Voltaje C.D.:
200mv / 2V / 20V / 200V / 1000V

Voltaje C.A.:
200V / 750V

Corriente Directa C.D.:
20mA / 200mA / 10A

Resistencia:
200Ω / 2kΩ / 20kΩ / 200kΩ / 2MΩ / 20MΩ

Temperatura:
-20°C hasta 750°C (-4°F to 1382°F)

Intervalo:
3-4-5-6-8CYL

Tacómetro:
3-4-5-6-8CYL (x 10rpm)



MDA-129 AD28003

EMPAQUE	PZAS.	PESO	GARANTÍA
Caja Color	1/20	0.65 Kg	1 año

Probadores de Corriente / CIRCUIT TESTERS

Corriente alterna

AC Power

**80-500
V / CA**



PROCOA-19 AD08010

EMPAQUE	PZAS.	PESO	GARANTÍA
Blisters	12/96	0.1 Kg	6 meses

Latonado

Brass

**6-12-24
V / CD**



PROCOL-10 AD08011

EMPAQUE	PZAS.	PESO	GARANTÍA
Blisters	12/96	0.1 Kg	6 meses

Trabajo pesado

HD

6-12 V / CD



PROCUP-20 AD08012

EMPAQUE	PZAS.	PESO	GARANTÍA
Blisters	6/48	0.16 Kg	6 meses

Soldadoras / WELDING MACHINES

Cortadora de plasma

Plasma cutter

**40 A
110 VCA**

VENTAJAS

Velocidad de corte: 1.8 veces más rápida que el oxicorte, mejor calidad en el corte, mayor seguridad al operario, utiliza aire comprimido



Corte máximo 10 mm
Corte óptimo 6.6 mm

COTP-40 AD29008

EMPAQUE	PZAS.	PESO	GARANTÍA	CONEXIÓN
Caja Color	1	12 Kg	1 año	Contacto

Incluye:

- Antorcha de corte
- Pinza de tierra
- Filtro de agua
- Caretta para soldar

Soldadora TIG y Stick

Tig and stick welding machine

**200 A
BIVOLTAJE
110/220 VCA**



SOLTIG-200 AD29009

EMPAQUE	PZAS.	PESO	GARANTÍA
Caja Color	1	4 Kg	1 año

Incluye:

- Caretta electrónica
- Cable porta electrodo
- Cable pinza de tierra
- Antorcha tig
- Consumibles





desde 1960

Soldadoras / WELDING MACHINES

Tipo inversor

Inverter welding
130 A
110 VCA

TECNOLOGÍA IGBT
Grosor de electrodo
requerido: 3/32"



Incluye:
•Cable porta electrodo
•Cable de pinza de tierra
•Caretas para soldar de mano

SOL-130I AD29006

EMPAQUE	PZAS.	PESO	GARANTÍA	CONEXIÓN
Caja Color	1	6 Kg	1 año	Contacto

Tipo inversor

Inverter welding
160 A
BIVOLTAJE
110/220 VCA

TECNOLOGÍA IGBT
Grosor de electrodo
requerido: 3/32", 1/8"



Incluye:
•Cable porta electrodo
•Cable de pinza de tierra
•Caretas electrónica

SOL-160I AD29004

EMPAQUE	PZAS.	PESO	GARANTÍA	CONEXIÓN
Caja Color	1	7.3 Kg	1 año	Contacto

Tipo inversor

Inverter welding
200 A
BIVOLTAJE
110/220 VCA

TECNOLOGÍA IGBT
Grosor de electrodo
requerido: 3/32", 1/8", 5/32"



Incluye:
•Cable porta electrodo
•Cable de pinza de tierra
•Caretas electrónica

SOL-200I AD29007

EMPAQUE	PZAS.	PESO	GARANTÍA	CONEXIÓN
Caja Color	1	7 Kg	1 año	Contacto

Micro alambre

Welding MIG
130 A
110 VCA

Grosor máximo de
alambre: 0.9 mm
Puede operar CON
y SIN gas



Incluye:
•Antorcha
•Pinza de tierra
•Caretas para soldar

SOLMIG-130 AD29005

EMPAQUE	PZAS.	PESO	GARANTÍA	CONEXIÓN
Caja Color	1	26 Kg	1 año	Contacto

De Electrodo

Electrodo
100 A
110 VCA



Incluye:
1 Pinza de conexión a tierra, 1 Pinza porta electrodo, 1 Cable para electrodo de 2 m, 1 Cable para conexión a tierra de 1.5 m, 1 Cable de conexión a la corriente eléctrica de 2 m, 1 Careta para soldar de una mano, 1 Cepillo de alambre

SOL-100 AD29002

EMPAQUE	PZAS.	PESO	GARANTÍA	CONEXIÓN
Caja Color	1	12.7 Kg	1 año	Contacto

Micro alambre y Electrodo Inverter **NEW!**

Electrodo
200 A
BIVOLTAJE
110/220 VCA



Incluye:
•Antorcha
•Pinza de tierra
•Porta Electrodo

SOLMIG-200I AD29011

EMPAQUE	PZAS.	PESO	GARANTÍA	CONEXIÓN
Caja Color	1	11.4 Kg	2 años	Contacto

De Electrodo

Electrodo
200 A
110/220 VCA

Acepta Electrodo:
3/32", 1/8", 5/32"



Incluye:
•Cable porta electrodo
•Cable pinza de tierra
•Caretas para soldar a una mano

SOL-250A AD29003

EMPAQUE	PZAS.	PESO	GARANTÍA
Caja Color	1	21.3 Kg	1 año

Caretas para soldar electrónica

Electronic welding mask

Área de Visión:
94mm X 36.5mm

RANGO DE SOMBRA :
DE 9 A 13



CS-E AD29001

EMPAQUE	PZAS.	PESO	GARANTÍA
Caja Color	10	1.8 Kg	6 meses

Caretas para soldar electrónica

Electronic welding mask

Área de Visión:
90mm X 34mm

RANGO DE SOMBRA :
DE 9 A 13



CSE-1 AD29010

EMPAQUE	PZAS.	PESO	GARANTÍA
Caja Color	1/4	5 Kg	6 meses





12 Volts / 12V

Aspiradora inalámbrica USB

Rechargeable vacuum W/USB connection



ASL-USB AA02112

EMPAQUE	PZAS.	PESO	GARANTÍA
Caja Color	16	1 Kg	1 año

Aspiradora sólidos y líquidos

Vacuum cleaner



ASL-12E AA02099

EMPAQUE	PZAS.	PESO	GARANTÍA	CONEXIÓN
Blister	12	0.5 Kg	1 año	12 V

Longitud del cable 3 m
Cable length: 3 m

Aspiradora para auto

Vacuum cleaner

Incluye esquinero.
Crevice tool included



Longitud del cable 5 m
Cable length: 5 m

AA-12 AA02001

EMPAQUE	PZAS.	PESO	GARANTÍA	CONEXIÓN
Caja Color	6	0.8 Kg	3 meses	12 V

Aspiradora sólidos y líquidos

Vacuum cleaner



Longitud del cable 5 m
Cable length: 5 m

ASL-12 AA02002

EMPAQUE	PZAS.	PESO	GARANTÍA	CONEXIÓN
Caja Color	6	1 Kg	3 meses	12 V

Aspiradora sólidos y líquidos

Vacuum cleaner

160 Watts



Longitud del cable 3 m
Cable length: 3 m

AASL-160 AA02106

EMPAQUE	PZAS.	PESO	GARANTÍA	CONEXIÓN
Caja Color	4	1.2 Kg	6 meses	12 V

Mini compresor de aire

Air compressor

250 PSI



Longitud del cable 3 m
Cable length: 3 m

NCA-2 AA02050

EMPAQUE	PZAS.	PESO	GARANTÍA	CONEXIÓN
Blister	10	0.54 Kg	6 meses	12 V





12 Volts / 12V

Mini compresor de aire

Air compressor
250 PSI



Longitud del cable 3 m
Cable length: 3 m

W-1711 AA02087

EMPAQUE	PZAS.	PESO	GARANTÍA	CONEXIÓN
Blisters	10	0.8 Kg	6 meses	12 V

Mini compresor de aire 3 en 1

3 in 1 air compressor
300 PSI



Longitud del cable 3 m
Cable length: 3 m

CA-31 AA02012

EMPAQUE	PZAS.	PESO	GARANTÍA	CONEXIÓN
Blisters	10	1 Kg	6 meses	12 V

Compresor de aire recargable 5 en 1

5 in 1 rechargeable air compressor
250 PSI



Longitud del cable 3 m
Cable length: 3 m

CR-51 AA02021

EMPAQUE	PZAS.	PESO	GARANTÍA	CONEXIÓN
Caja Color	4	4 Kg	6 meses	12 V

Mini compresor de aire 4 en 1

4 in 1 air compressor
300 PSI

Medidor de presión,
luz de emergencia,
lámpara intermitente.



Longitud del cable 3 m
Cable length: 3 m

W-1557 AA02086

EMPAQUE	PZAS.	PESO	GARANTÍA	CONEXIÓN
Caja Color	10	1.4 Kg	6 meses	12 V

Inversor de corriente

Power inverter
500 W
Incluye 2 Puertos USB



C-1250 AA02095

EMPAQUE	PZAS.	PESO	GARANTÍA	CONEXIÓN
Blisters	1/10	1 Kg	1 año	12 V

Inversor de corriente

Power inverter
1000 W
Incluye 2 Puertos USB



C-12100 AA02096

EMPAQUE	PZAS.	PESO	GARANTÍA	CONEXIÓN
Blisters	1/10	1 Kg	1 año	12 V

NEW!





SUMINISTROS
INDUSTRIALES
DÍAZ

MIKEL'S

MIKEL'S MR



Línea **Ferretería**



7821606595
7821604051
7821610766



contacto@sidadz.com



www.sidadz.com





desde 1960

Cajas para Herramientas / TOOL BOXES

Plásticas

Plastic
1.5 lts
16"

Fabricada en Propileno de alto impacto



CHP-160 AE18005

EMPAQUE	PZAS.	PESO	GARANTÍA
Granel	12	0.9 kg	6 meses

Plásticas

Plastic
2.8 lts
19"

Fabricada en Propileno de alto impacto



CHP-190 AE18006

EMPAQUE	PZAS.	PESO	GARANTÍA
Granel	12	1.4 kg	6 meses

Bombas de Aire / AIR PUMPS

Con pedal de cilindro sencillo

Single cylinder pedal

125 PSI



B/P AE06002

EMPAQUE	PZAS.	PESO	GARANTÍA
Caja Color	25	1 kg	6 meses

Balonera

Ball pump

Incluye:

- Manguera flexible
- Boquilla para balones



BB-3 AE06005

EMPAQUE	PZAS.	PESO	GARANTÍA
Caballote	20/200	0.14 kg	6 meses

De lujo mango de madera

Deluxe wooden handle

125 PSI



B/N AE06001

EMPAQUE	PZAS.	PESO	GARANTÍA
Caja Color	25	1.1 kg	6 meses

Cables y Candados de seguridad / SECURITY CABLES AND PADLOCKS

Boquillas para balón

Ball needle valves

5 pzs



BB-5 AE06006

EMPAQUE	PZAS.	PESO	GARANTÍA
Blisters	10	0.02 kg	6 meses

Flexible 4 llaves de seguridad

Security padlock cable-4 security keys

90 cm

Ø=15mm

Incluye:

- 3 Llaves



C-1690 AE10002

EMPAQUE	PZAS.	PESO	GARANTÍA
Blisters	5/40	0.5 kg	1 año

Flexible 4 llaves de seguridad

Security padlock cable-4 security keys

1 m

Ø=25.4 mm

Incluye:

- 3 Llaves



C-4612 AE10004

EMPAQUE	PZAS.	PESO	GARANTÍA
Blisters	12	1.5 kg	1 año





Cables y Candados de seguridad / SECURITY CABLES AND PADLOCKS

Flexible 2 llaves planas

Flexible padlock cable- 2 flat keys

80 cm

Ø=15 mm

Incluye:

- 2 Llaves



C-1590 AE10001

EMPAQUE	PZAS.	PESO	GARANTÍA
Blisters	40	0.5 kg	1 año

Flexible 2 llaves planas

Flexible padlock cable- 2 flat keys

80 cm

Ø=18 mm

Incluye:

- 2 Llaves



C-1880 AE10003

EMPAQUE	PZAS.	PESO	GARANTÍA
Blisters	60	0.6 kg	1 año

De espiral retráctil con combinación 4 dígitos cabeza metálica

Retractable spiral padlock cable
with combination and metal head

1 m

Ø=8 mm



CCE-8100 AE10008

EMPAQUE	PZAS.	PESO	GARANTÍA
Blisters	20/60	0.20 kg	1 año

Flexible HD 4 llaves de seguridad

HD flexible- 4 security keys

1.5 m

Ø=25.4 mm

MEJORADO



C-4613 AE10005

EMPAQUE	PZAS.	PESO	GARANTÍA
Blisters	6	2 kg	1 año

Con cadena

Flexible with steel cover

90 cm

Eslabon de:

6 mm



Incluye
•3 llaves de
seguridad
uso rudo

•3 security keys
Heavy duty

CM-90 AE10011

EMPAQUE	PZAS.	PESO	GARANTÍA
Blisters	12	1.1 kg	1 año

Combinación uso rudo

Heavy duty combination lock

1 m

Ø=22.2 mm



CB-22 AE10006

EMPAQUE	PZAS.	PESO	GARANTÍA
Blisters	6	1 kg	1 año

Flexible inviolable con cubierta de acero

Flexible with steel cover

1 m

Ø=25.4 mm



Incluye:
•4 llaves de seguridad
•4 security keys

CCFI-1150 AE10009

EMPAQUE	PZAS.	PESO	GARANTÍA
Blisters	12	1.1 kg	1 año

Flexibles de seguridad doble lazo

Double loop cable

1.2 m

Ø=8mm



CSDL-12 AE10012

EMPAQUE	PZAS.	PESO	GARANTÍA
Blisters	6	1.64 kg	1 año

Flexibles de seguridad doble lazo

Double loop cable

1.5 m

Ø=15mm



CSDL-15 AE10013

EMPAQUE	PZAS.	PESO	GARANTÍA
Blisters	20/60	2 kg	1 año

Flexibles de seguridad doble lazo

Double loop cable

3 m

Ø=15mm



CSDL-30 AE10014

EMPAQUE	PZAS.	PESO	GARANTÍA
Blisters	12/24	3.5 kg	1 año





Carpas para Jardín / GAZEBO

3 X 3 m

- Incluye:
- Bolsa de almacenaje
 - Tela con protección UV



CPI-330	AE20001		
EMPAQUE	PZAS.	PESO	GARANTÍA
Caja	1	20.1 kg	1 año

3 X 4.5 m

- Incluye:
- Bolsa de almacenaje
 - Tela con protección UV



CPI-345	AE20002		
EMPAQUE	PZAS.	PESO	GARANTÍA
Caja	1	28.5 kg	1 año

Cinchos de plástico / CABLE TIES

Negros 100 piezas



2.5 X 190 mm

CDP100-25X190	AE06012		
EMPAQUE	PZAS.	PESO	GARANTÍA
Caballete	200	0.06kg	1 año

4.6 X 300 mm

CDP100-46X300	AE06018		
EMPAQUE	PZAS.	PESO	GARANTÍA
Caballete	100	0.2kg	1 año

2.5 X 150 mm

CDP100-25X150	AE06010		
EMPAQUE	PZAS.	PESO	GARANTÍA
Caballete	100	0.05kg	1 año

4.6 X 370 mm

CDP100-46X370	AE06020		
EMPAQUE	PZAS.	PESO	GARANTÍA
Caballete	50	0.2kg	1 año

Blancos 100 piezas

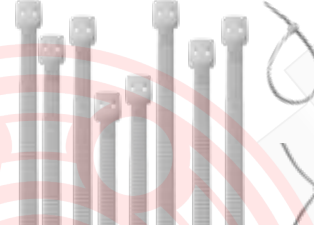

2.5 X 190 mm

CDP100-25X190B	AE06013		
EMPAQUE	PZAS.	PESO	GARANTÍA
Caballete	200	0.06kg	1 año

4.6 X 300 mm

CDP100-46X300B	AE06019		
EMPAQUE	PZAS.	PESO	GARANTÍA
Caballete	100	0.2kg	1 año

2.5 X 150 mm

CDP100-25X150B	AE06011		
EMPAQUE	PZAS.	PESO	GARANTÍA
Caballete	100	0.05kg	1 año

4.6 X 370 mm

CDP100-46X370B	AE06021		
EMPAQUE	PZAS.	PESO	GARANTÍA
Caballete	50	0.2kg	1 año

Bote de plástico
Plastic canister

- 1000 pzas**
- Incluye:
- 2.5 X 100 mm (500 pzas)
 - 4.6 X 200 mm (400 pzas)
 - 4.7 X 300 mm (100 pzas)



CDP-1000	AE06009		
EMPAQUE	PZAS.	PESO	GARANTÍA
Bote de plástico	20	0.8 kg	1 año

Calafateadora / CAULKING GUN

Tipo pistola (dentada)
Ratchet caulking gun



Para cartuchos de 300 ml

CP-2	AE06022		
EMPAQUE	PZAS.	PESO	GARANTÍA
Caballete	24	0.4 kg	1 año

Lentes / GOOGLES

De protección para trabajo
Protective eyeglasses



Cuenta con 4 respiraderos

LTV-1	AE06050		
EMPAQUE	PZAS.	PESO	GARANTÍA
Blister	150	0.07kg	2 años

Embudos Plásticos / PLASTIC TUNNEL

Flexible con extensión
With flexible extension



EFE-24	AE9005		
EMPAQUE	PZAS.	PESO	GARANTÍA
Caja	6	1 kg	3 meses

Con filtro
With filter

5"
Filtro de acero inoxidable
Stainless steel filter



EPF-05	AE09001		
EMPAQUE	PZAS.	PESO	GARANTÍA
Granel	6	0.03 kg	6 meses

Con filtro
With filter

7"
Filtro de acero inoxidable
Stainless steel filter



EPF-07	AE09002		
EMPAQUE	PZAS.	PESO	GARANTÍA
Granel	6	0.11 kg	6 meses





Diablos Plegables / FOLDING HAND CRAFT

60 kg

Incluyen bungees



DP-60 AE06024

EMPAQUE	PZAS.	PESO	GARANTÍA
Caja Color	5	3.1 kg	6 meses

90 kg

Incluyen bungees



DP-90 AE06025

EMPAQUE	PZAS.	PESO	GARANTÍA
Caja Color	5	4.1 kg	6 meses

Engrapadora tipo pistola

Stapler

Incluye

+500 grapas de 5/16"

+500 grapas de 1/2"



ETP-1000 AE06026

EMPAQUE	PZAS.	PESO	GARANTÍA
Blister	12	1 kg	3 meses

**Chaleco de seguridad
reflejante**

Safety vest



100% Poliéster
Confeccionado
en tela de alta
visibilidad franjas
reflejantes de 5cm

CHS-1 AE28001

EMPAQUE	PZAS.	PESO	GARANTÍA
Caballote	1/12	0.17 kg	3 meses

**Chaleco de seguridad
reflejante naranja**

Safety vest



100% Poliéster
Confeccionado
en tela de alta
visibilidad, franjas
reflejantes de 5cm

CHS-2 AA28010

EMPAQUE	PZAS.	PESO	GARANTÍA
Caballote	1/12	0.91	2 años

Impermeable tipo manga

Raincoat

100% PVC



IMA-06 AA28001

EMPAQUE	PZAS.	PESO	GARANTÍA
Caballote	24	0.42 kg	3 meses

Estantes para Almacenaje / STORAGE RACKS

Metálico

Metallic

48 X 18"

5 repisas

500 kg



Repisas de
madera aglomerada
MDF Shelves

EMA-4824 AE18008

EMPAQUE	PZAS.	PESO	GARANTÍA
Caja	1	56.5 kg	1 año

Metálico industrial

Metallic

77 X 24"

4 Repisas

2500 kg



Repisas de
malla metálica
Wire with
mesh shelves

EMI-7724 AE18009

EMPAQUE	PZAS.	PESO	GARANTÍA
Caja	1	86 kg	1 año





desde 1960

Equipos para pintura / PAINTING EQUIPMENT

Aerógrafo acción simple

Air brush set

35 PSI
22 c.c.



A-22 AE31001

EMPAQUE	PZAS.	PESO	GARANTÍA
Caja Color	1/40	0.38 kg	6 meses

Aerógrafo semi profesional

Air brush set

35 PSI
40 c.c.



ASP-40 AE31002

EMPAQUE	PZAS.	PESO	GARANTÍA
Caja Color	1/20	0.3 kg	6 meses

Compresor para Aerógrafo

Air brush compressor

1/4 HP
65l/min



CPA-1 AD04009

EMPAQUE	PZAS.	PESO	GARANTÍA
Caja Color	1/4	4.2 kg	6 meses

Pistola eléctrica para pintado HVLP

Electric paint gun

700 ml
300W



PPE-300 AD04026

EMPAQUE	PZAS.	PESO	GARANTÍA	CONEXIÓN
Caja Color	1/4	1.7 kg	1 año	Contacto

Pistola eléctrica para pintado

Electric paint gun

700 ml
500W



PPE-600 AD04027

EMPAQUE	PZAS.	PESO	GARANTÍA	CONEXIÓN
Caja Color	1/4	3 kg	1 año	Contacto

Pistola de aire para pintar

Spraying gun

70 PSI
400 c.c.



PGP-400 AE31003

EMPAQUE	PZAS.	PESO	GARANTÍA
Caja Color	10	0.74 kg	1 año

Pistola para pintar HVLP gravedad

HVLP spray gun

600 ml



PGP-600 AE31004

EMPAQUE	PZAS.	PESO	GARANTÍA
Caja Color	1/20	0.9 kg	1 año

Pistola para pintar HVLP succión

HVLP spray gun

1 lts



PSP-1000 AE31005

EMPAQUE	PZAS.	PESO	GARANTÍA
Caja Color	1/10	1.2 kg	1 año

Pistola para recubrimiento automotriz

Under cover coating gun



PRA-1 AA19021

EMPAQUE	PZAS.	PESO	GARANTÍA
Caja Color	6/36	0.15 kg	1 año

Tanque industrial para pintar

Industrial painting tank

10 lts



TIP-10 AE34001

EMPAQUE	PZAS.	PESO	GARANTÍA
Caja Color	1	11.2 kg	1 año





Eslingas / TIE DOWMS

Factor de seguridad 4:1

4 Toneladas 4 t

2"



4 m

S2-4M2 AE13007			
EMPAQUE	PZAS.	PESO	GARANTÍA
Granel	6	0.9 kg	6 meses

8 m

S2-8M2 AE13009			
EMPAQUE	PZAS.	PESO	GARANTÍA
Granel	4	1.6 kg	6 meses

6 m

S2-6M2 AE13008			
EMPAQUE	PZAS.	PESO	GARANTÍA
Granel	6	1.2 kg	6 meses

10 m

S2-10M2 AE13006			
EMPAQUE	PZAS.	PESO	GARANTÍA
Granel	7	2 kg	6 meses

Factor de seguridad 4:1

6 Toneladas 6 t

3"

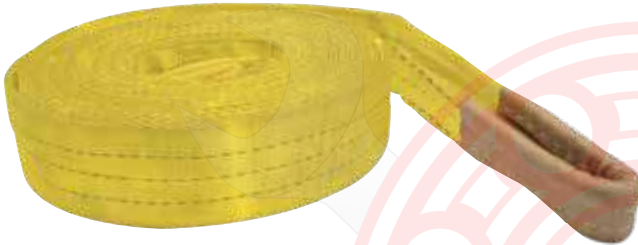

4 m

S3-4M3 AE13011			
EMPAQUE	PZAS.	PESO	GARANTÍA
Granel	6	1.45 kg	6 meses

8 m

S3-8M3 AE13013			
EMPAQUE	PZAS.	PESO	GARANTÍA
Granel	4	2.69 kg	6 meses

6 m

S3-6M3 AE13012			
EMPAQUE	PZAS.	PESO	GARANTÍA
Granel	6	2 kg	6 meses

10 m

S3-10M3 AE13010			
EMPAQUE	PZAS.	PESO	GARANTÍA
Granel	4	3.38 kg	6 meses

Factor de seguridad 4:1

8 Toneladas 8 t

4"



4 m

S4-4M4 AE13015			
EMPAQUE	PZAS.	PESO	GARANTÍA
Granel	6	1.7 kg	6 meses

8 m

S4-8M4 AE13017			
EMPAQUE	PZAS.	PESO	GARANTÍA
Granel	4	3.3 kg	6 meses

6 m

S4-6M4 AE13016			
EMPAQUE	PZAS.	PESO	GARANTÍA
Granel	6	2.5 kg	6 meses

10 m

S4-10M4 AE13014			
EMPAQUE	PZAS.	PESO	GARANTÍA
Granel	4	4.2 kg	6 meses

Factor de seguridad 4:1

**1 t
1"
1 m**

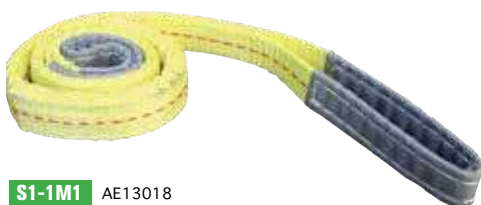

S1-1M1 AE13018			
EMPAQUE	PZAS.	PESO	GARANTÍA
Granel	6/48	0.25 kg	6 meses

ANCHO	KILOGRAMOS VERTICAL					
		KG CON TENSIÓN	KG EN CANASTA 90°	KG EN CANASTA 60°	KG EN CANASTA 45°	KG EN CANASTA 30°
1 PULGADA	1000	800	2000	1600	1400	1000
2 PULGADAS	2,000	1,600	4,000	3,400	2,800	2,000
3 PULGADAS	3,000	2,400	6,000	5,100	4,200	3,000
4 PULGADAS	4,000	3,200	8,000	6,800	5,600	4,000





desde 1960

Guantes para trabajo / PAINTING EQUIPMENT

Algodón con puntos de PVC
Cotton with PVC dots



GPVC-2	AE06043		
EMPAQUE	PZAS.	PESO	GARANTÍA
Caballote	80	0.1 kg	6 meses

Carnaza con loneta
Split cowhide palm and canvas



GCL-2	AE06027		
EMPAQUE	PZAS.	PESO	GARANTÍA
Caballote	60	0.1 kg	6 meses

Nitrilo con forro de algodón
Nitrile dipped cotton gloves



GNFA-2	AE06042		
EMPAQUE	PZAS.	PESO	GARANTÍA
Caballote	60/120	0.1 kg	6 meses

Nylon con espuma de nitrilo
Nitrile dipped cotton gloves

Chicos

GEN-2S	AE06031		
EMPAQUE	PZAS.	PESO	GARANTÍA
Caballote	12/144	0.05 kg	6 meses

Medianos

GEN-2M	AE06030		
EMPAQUE	PZAS.	PESO	GARANTÍA
Caballote	12/144	0.05 kg	6 meses

Grandes

GEN-2G	AE06029		
EMPAQUE	PZAS.	PESO	GARANTÍA
Caballote	12/144	0.05 kg	6 meses



Para mecánico semi pro
Mechanic's semi pro gloves

Medianos

GMSP-2M	AE06039		
EMPAQUE	PZAS.	PESO	GARANTÍA
Caballote	12/48	0.1 kg	6 meses

Grandes

GMSP-2G	AE06038		
EMPAQUE	PZAS.	PESO	GARANTÍA
Caballote	12/48	0.1 kg	6 meses



Para mecánico máximo agarre
Mechanic gloves / Maximun grip

Medianos

GMMA-2M	AE06035		
EMPAQUE	PZAS.	PESO	GARANTÍA
Caballote	12/48	0.1 kg	6 meses

Grandes

GMMA-2G	AE06034		
EMPAQUE	PZAS.	PESO	GARANTÍA
Caballote	12/48	0.1 kg	6 meses



Para mecánico piel sintética
Mechanic gloves

Medianos

GM-2	AE06032		
EMPAQUE	PZAS.	PESO	GARANTÍA
Caballote	12/48	0.16 kg	6 meses

Grandes

GM-2G	AE06033		
EMPAQUE	PZAS.	PESO	GARANTÍA
Caballote	12/48	0.16 kg	6 meses



Profesionales para mecánico acolchonados
Professional mechanic gloves

Medianos

GMP-2	AE06036		
EMPAQUE	PZAS.	PESO	GARANTÍA
Caballote	12/48	0.16 kg	6 meses

Grandes

GMP-2G	AE06037		
EMPAQUE	PZAS.	PESO	GARANTÍA
Caballote	12/48	0.16 kg	6 meses



Para mecánico de lujo
Deluxe mechanic gloves

Medianos

GMX-2M	AE06041		
EMPAQUE	PZAS.	PESO	GARANTÍA
Caballote	12/48	0.11 kg	6 meses

Grandes

GMX-2G	AE06040		
EMPAQUE	PZAS.	PESO	GARANTÍA
Caballote	12/48	0.11 kg	6 meses





Herramienta de Mano / HAND TOOLS

Dados cortos

Sockets

1/4"

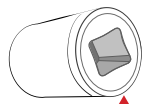

SOCKET 1/4"

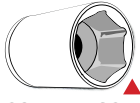

BOCA HEXAGONAL

MILIMÉTRICOS

5 mm **DC-0525**

AE14169

6 mm **DC-0625**

AE14170

7 mm **DC-0725**

AE14171

8 mm **DC-0825**

AE14172

9 mm **DC-0925**

AE14173

10 mm **DC-1025**

AE14174

11 mm **DC-1125**

AE14175

12 mm **DC-1225**

AE14176

13 mm **DC-1325**

AE14177

EMPAQUE	PZAS.	PESO	GARANTÍA
Caballote	12/720	0.02 Kg 0.03 Kg	2 años

ESTÁNDAR

5/32" DC-1525	AE14178	5/16" DC-3125	AE14183
3/16" DC-1825	AE14179	11/32" DC-3425	AE14184
7/32" DC-2125	AE14180	3/8" DC-3725	AE14185
1/4" DC-2525	AE14181	7/16" DC-4325	AE14186
9/32" DC-2825	AE14182	1/2" DC-5025	AE14187

Dados cortos

Sockets

3/8"



SOCKET 3/8"

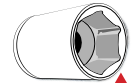

BOCA HEXAGONAL

MILIMÉTRICOS

8 mm **DC-0838**

AE14006

9 mm **DC-0938**

AE14007

10 mm **DC-1038**

AE14008

11 mm **DC-1138**

AE14010

12 mm **DC-1238**

AE14012

13 mm **DC-1338**

AE14014

14 mm **DC-1438**

AE14016

15 mm **DC-1538**

AE14018

17 mm **DC-1738**

AE14020

18 mm **DC-1838**

AE14022

19 mm **DC-1938**

AE14024

EMPAQUE	PZAS.	PESO	GARANTÍA
Caballote	12/720	0.04 Kg 0.07 Kg	2 años

ESTÁNDAR

3/8" DC-3738	AE14026	5/8" DC-6238	AE14034
7/16" DC-4338	AE14028	11/16" DC-6838	AE14036
1/2" DC-5038	AE14030	3/4" DC-7538	AE14038
9/16" DC-5638	AE14032	13/16" DC-8138	AE14040
		7/8" DC-8738	AE14042

Dados cortos

Sockets

1/2"



SOCKET 1/2"

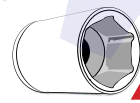

BOCA HEXAGONAL

MILIMÉTRICOS

10 mm **DC-1050**

AE14009

11 mm **DC-1150**

AE14011

12 mm **DC-1250**

AE14013

13 mm **DC-1350**

AE14015

14 mm **DC-1450**

AE14017

15 mm **DC-1550**

AE14019

17 mm **DC-1750**

AE14021

18 mm **DC-1850**

AE14023

19 mm **DC-1950**

AE14025

EMPAQUE	PZAS.	PESO	GARANTÍA
Caballote	6/288	0.07 Kg 0.13 Kg	2 años

ESTÁNDAR

3/8" DC-3750	AE14027	5/8" DC-6250	AE14035
7/16" DC-4350	AE14029	11/16" DC-6850	AE14037
1/2" DC-5050	AE14031	3/4" DC-7550	AE14039
9/16" DC-5650	AE14033	13/16" DC-8150	AE14041
		7/8" DC-8750	AE14043

Dados largos

Deep Sockets

3/8"

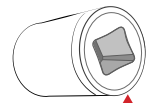

SOCKET 3/8"

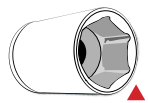

BOCA HEXAGONAL

MILIMÉTRICOS

10 mm **DL-1038**

AE14138

12 mm **DL-1238**

AE14139

13 mm **DL-1338**

AE14140

14 mm **DL-1438**

AE14141

16 mm **DL-1638**

AE14142

17 mm **DL-1738**

AE14143

18 mm **DL-1838**

AE14144

19 mm **DL-1938**

AE14145

EMPAQUE	PZAS.	PESO	GARANTÍA
Caballote	6/288	0.07 Kg 0.13 Kg	2 años

ESTÁNDAR

1/2" DL-5038	AE14146	11/16" DL-6838	AE14149
9/16" DL-5638	AE14147	3/4" DL-7538	AE14150
5/8" DL-6238	AE14148	13/16" DL-8138	AE14151





desde 1960

Herramienta de Mano / HAND TOOLS

Dados Largos

Deep Sockets

1/2"

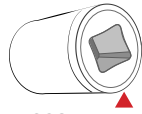

SOCKET 1/2"

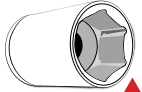

BOCA HEXAGONAL

MILIMÉTRICOS

10 mm	DL-1050 AE14153
12 mm	DL-1250 AE14154
13 mm	DL-1350 AE14155
14 mm	DL-1450 AE14156
16 mm	DL-1650 AE14157
17 mm	DL-1750 AE14158
18 mm	DL-1850 AE14159
19 mm	DL-1950 AE14160
21 mm	DL-2150 AE14161

EMPAQUE	PZAS.	PESO	GARANTÍA
Caballote	6/288	0.08 Kg 0.13 Kg	2 años

ESTÁNDAR

EMPAQUE	PZAS.	PESO	GARANTÍA
1/2"	DL-5050 AE14162	3/4"	DL-7550 AE14166
9/16"	DL-5650 AE14163	13/16"	DL-8150 AE14167
5/8"	DL-6250 AE14164	7/8"	DL-8750 AE14168
11/16"	DL-6850 AE14165		

Dados Adaptadores

Sockets adaptors



3/8" a 1/2"

DA-3850 AE14003

EMPAQUE	PZAS.	PESO	GARANTÍA
Caballote	6/336	0.06 Kg	2 años

1/4" a 3/8"

DA-2538 AE14001

EMPAQUE	PZAS.	PESO	GARANTÍA
Caballote	6/432	0.04 Kg	2 años

1/2" a 3/8"

DA-5038 AE14004

EMPAQUE	PZAS.	PESO	GARANTÍA
Caballote	6/432	0.06 Kg	2 años

3/8" a 1/4"

DA-3825 AE14002

EMPAQUE	PZAS.	PESO	GARANTÍA
Caballote	6/432	0.03 Kg	2 años

Extensiones

Extension bars



3/8" x 3"

EX38-3 AE14055

EMPAQUE	PZAS.	PESO	GARANTÍA
Caballote	5/50	0.08 Kg	2 años

3/8" x 6"

EX38-6 AE14056

EMPAQUE	PZAS.	PESO	GARANTÍA
Caballote	5/50	0.15 Kg	2 años

3/8" x 10"

EX38-10 AE14054

EMPAQUE	PZAS.	PESO	GARANTÍA
Caballote	5/50	0.15 Kg	2 años

Extensiones

Extension bars



1/2" x 3"

EX50-3 AE14058

EMPAQUE	PZAS.	PESO	GARANTÍA
Caballote	5/50	0.13 Kg	2 años

1/2" x 5"

EX50-5 AE14059

EMPAQUE	PZAS.	PESO	GARANTÍA
Caballote	5/50	0.21 Kg	2 años

1/2" x 10"

EX50-10 AE14057

EMPAQUE	PZAS.	PESO	GARANTÍA
Caballote	5/50	0.4 Kg	2 años

Matracas cabeza de PERA

Ratchets handle - pear type



1/4"

MAT-250 AE14133

EMPAQUE	PZAS.	PESO	GARANTÍA
Caballote	5/50	0.15 Kg	2 años

3/8"

MAT-375 AE14074

EMPAQUE	PZAS.	PESO	GARANTÍA
Caballote	5/50	0.39 Kg	2 años

1/2"

MAT-500 AE14075

EMPAQUE	PZAS.	PESO	GARANTÍA
Caballote	5/25	0.65 Kg	2 años





Herramienta de Mano / HAND TOOLS

Desarmadores magnetizados Cromo Vanadio (mango bimaterial)

Screwdrivers magnetized Cr-v (Two components handle)

Cruz 
Philips



1/4" x 1-1/2"

DCB-14112	AE14044		
EMPAQUE	PZAS.	PESO	GARANTÍA
Caballote	12/288	0.03 Kg	1 año

3/16" x 6"

DCB-3166	AE14047		
EMPAQUE	PZAS.	PESO	GARANTÍA
Caballote	12/240	0.07 Kg	1 año



1/4" x 6"

DCB-146	AE14046		
EMPAQUE	PZAS.	PESO	GARANTÍA
Caballote	12/144	0.11 Kg	1 año

1/4" x 4"

DCB-144	AE14045		
EMPAQUE	PZAS.	PESO	GARANTÍA
Caballote	12/144	0.09 Kg	1 año

Cruz 
Philips

3/16" x 8"

DCB-3168	AE14048		
EMPAQUE	PZAS.	PESO	GARANTÍA
Caballote	12/240	0.09 Kg	1 año

Desarmadores magnetizados Cromo Vanadio (mango bimaterial)

Screwdrivers magnetized Cr-v (Two components handle)

Plano 
Slotted, CrV Bar



1/4" x 1-1/2"

DPB-14112	AE14050		
EMPAQUE	PZAS.	PESO	GARANTÍA
Caballote	12/240	0.05 Kg	1 año

1/4" x 4"

DPB-144	AE14051		
EMPAQUE	PZAS.	PESO	GARANTÍA
Caballote	12/144	0.09 Kg	1 año



1/4" x 6"

DPB-146	AE14052		
EMPAQUE	PZAS.	PESO	GARANTÍA
Caballote	12/144	0.11 Kg	1 año

5/16" x 6"

DPB-5166	AE14048		
EMPAQUE	PZAS.	PESO	GARANTÍA
Caballote	6/96	0.15 Kg	1 año

Plano 
Slotted, CrV Bar

Desarmador con puntas intercambiables

Screwdriver Set
4 en 1





 3mm - 5mm
 #1 - #2



DB-41	AE14005		
EMPAQUE	PZAS.	PESO	GARANTÍA
Blisters	12/288	0.31 Kg	1 año

Desarmador con puntas intercambiables

Screwdrivers Set
6 en 1





 3 / 16" (4,76 mm)
 1/4" (6,35mm)
 #1 - #2
 5/16" (7,9 mm)
 1/4" (6,35 mm)







DP-61	AE14049		
EMPAQUE	PZAS.	PESO	GARANTÍA
Blisters	12/72	0.19 Kg	1 año

Juego de desarmadores

Screwdrivers Set
9 Piezas

 #2 x 6"
 #2 x 4"
 #1 x 3"
 #0 x 3"



 5/16"x 6"
 1/4"x 6"
 1/4"x 4"
 3/16"x 3"
 1/8"x 3"





JDB-9	AE14066		
EMPAQUE	PZAS.	PESO	GARANTÍA
Blisters	6/12	1.08 Kg	1 año

Juego de desarmadores

Screwdrivers Set
6 Piezas

 #0 x 3"
 #1 x 4"
 #2 x 5"





 1/4"x 6"
 5/32"x 4"
 1/8"x 3"







JDB-6	AE14065		
EMPAQUE	PZAS.	PESO	GARANTÍA
Blisters	12/72	0.19 Kg	1 año

Juego de desarmadores

Screwdrivers Set
12 Piezas

 #3 x 6"
 #2 x 4"
 #1 x 3"
 #0 x 3"
 #2 x 11/2"

 5/16"x 6"
 1/4"x 6"
 1/4"x 11/2"
 3/16"x 3"
 1/8"x 3"

S1 x 4"
S2 x 4"



JDB-12	AE14064		
EMPAQUE	PZAS.	PESO	GARANTÍA
Blisters	6/12	1.16 Kg	1 año





desde 1960

Herramienta de Mano / HAND TOOLS

Desarmadores barra Acero Cromado, mango PVC
Screwdrivers (pvc handle) Cromed Steel Bar

Cruz 
Philips



3/16" x 3"

DC-3163	BE14008
EMPAQUE	PZAS. PESO GARANTÍA
Caballete	12/96 0.05 Kg 1 año

3/16" x 6" Tamer

DC-3166	BE14009
EMPAQUE	PZAS. PESO GARANTÍA
Caballete	12/96 0.07 Kg 1 año

3/16" x 8"

DC-3168	BE14010
EMPAQUE	PZAS. PESO GARANTÍA
Caballete	12/96 0.09 Kg 1 año

1/4" x 1-1/2"

DC-14112	BE14001
EMPAQUE	PZAS. PESO GARANTÍA
Caballete	12/144 0.05 Kg 1 año

1/4" x 4"

DC-144	BE14002
EMPAQUE	PZAS. PESO GARANTÍA
Caballete	12/96 0.07 Kg 1 año

Desarmadores barra Acero Cromado, mango PVC
Screwdrivers (pvc handle) Cromed Steel Bar

Cruz 
Philips



1/4" x 6"

DC-146	BE14003
EMPAQUE	PZAS. PESO GARANTÍA
Caballete	12/96 0.08 Kg 1 año

1/4" x 8" Tamer

DC-148	BE14004
EMPAQUE	PZAS. PESO GARANTÍA
Caballete	12/96 0.07 Kg 1 año

1/8" x 4"

DC-184	BE14005
EMPAQUE	PZAS. PESO GARANTÍA
Caballete	12/96 0.04 Kg 1 año

1/8" x 6"

DC-186	BE14006
EMPAQUE	PZAS. PESO GARANTÍA
Caballete	12/96 0.05 Kg 1 año

1/8" x 8"

DC-188	BE14007
EMPAQUE	PZAS. PESO GARANTÍA
Caballete	12/96 0.05 Kg 1 año

Desarmadores barra Acero Cromado, mango PVC
Screwdrivers (pvc handle) Cromed Steel Bar

Plano 
Slotted, CrV Bar



3/16" x 4"

DP-3164	BE14014
EMPAQUE	PZAS. PESO GARANTÍA
Caballete	12/96 0.06 Kg 1 año

3/16" x 6" Tamer

DP-3166	BE14015
EMPAQUE	PZAS. PESO GARANTÍA
Caballete	12/96 0.08 Kg 1 año

1/4" x 1 1/2"

DP-14112	BE14011
EMPAQUE	PZAS. PESO GARANTÍA
Caballete	12/144 0.05 Kg 1 año

1/4" x 4"

DP-144	BE14012
EMPAQUE	PZAS. PESO GARANTÍA
Caballete	12/96 0.07 Kg 1 año

1/4" x 6"

DP-146	BE14013
EMPAQUE	PZAS. PESO GARANTÍA
Caballete	12/96 0.08 Kg 1 año

Juego de desarmadores barra acero carbono

Screwdrivers Set

6 Piezas

Tamer

 1/4" x 6"
1/4" x 4"

 3/16" x 3"
5/16" x 6"
1/4" x 6"
1/4" x 4"

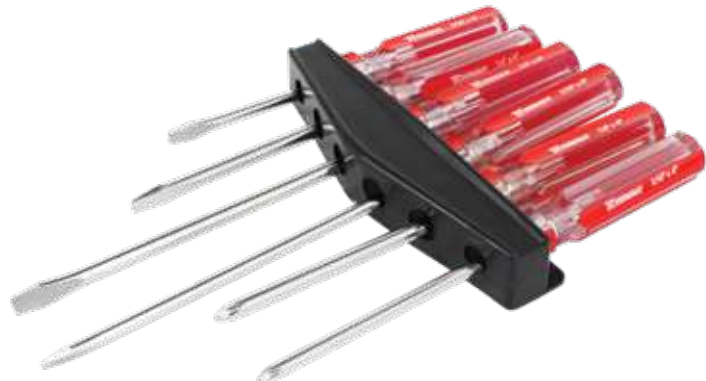

Tamer

JD-6	BE14016
EMPAQUE	PZAS. PESO GARANTÍA
Blister	6/24 1.16 Kg 1 año





Herramienta de Mano / HAND TOOLS

Pinzas de electricista

Lineman pliers



PE-7	AE14099	7"	
EMPAQUE	PZAS.	PESO	GARANTÍA
Caballote	5/50	0.29 Kg	2 años

PE-8	AE14100	8"	
EMPAQUE	PZAS.	PESO	GARANTÍA
Caballote	5/50	0.38 Kg	2 años

PE-9	AE14132	9"	
EMPAQUE	PZAS.	PESO	GARANTÍA
Caballote	5/50	0.49 Kg	2 años

Pinzas de punta

Nose pliers



PP-6	AE14103	6"	
EMPAQUE	PZAS.	PESO	GARANTÍA
Caballote	5/50	0.17 Kg	2 años

PP-7	AE14104	7"	
EMPAQUE	PZAS.	PESO	GARANTÍA
Caballote	5/50	0.23 Kg	2 años

PP-8	AE14105	8"	
EMPAQUE	PZAS.	PESO	GARANTÍA
Caballote	5/50	0.25 Kg	2 años

Pinzas de corte diagonal

Diagonal cutting pliers



PCD-5	AE14094	5"	
EMPAQUE	PZAS.	PESO	GARANTÍA
Caballote	5/50	0.19 Kg	2 años

PCD-6	AE14095	6"	
EMPAQUE	PZAS.	PESO	GARANTÍA
Caballote	5/50	0.19 Kg	2 años

PCD-7	AE14096	7"	
EMPAQUE	PZAS.	PESO	GARANTÍA
Caballote	5/50	0.27 Kg	2 años

Pinzas de chofer

Slip joint pliers



PCH-6	AE14097	6"	
EMPAQUE	PZAS.	PESO	GARANTÍA
Caballote	5/50	0.16 Kg	2 años

PCH-8	AE14098	8"	
EMPAQUE	PZAS.	PESO	GARANTÍA
Caballote	5/50	0.28 Kg	2 años

Pinzas para anillos de retención interior

Cir clip pliers



PARI	AE14093		
EMPAQUE	PZAS.	PESO	GARANTÍA
Caballote	5/50	0.17 Kg	2 años

Pinzas para anillos de retención exterior

Cir clip pliers



PARE	AE14092		
EMPAQUE	PZAS.	PESO	GARANTÍA
Caballote	5/50	0.17 Kg	2 años

Pinzas para anillos de retención. Curvas interior

Circlip pliers



PARCI	AE14091		
EMPAQUE	PZAS.	PESO	GARANTÍA
Caballote	5/50	0.17 Kg	2 años

Pinzas para anillos de retención. Curvas exterior

Circlip pliers



PARCE	AE14090		
EMPAQUE	PZAS.	PESO	GARANTÍA
Caballote	5/50	0.17 Kg	2 años





desde 1960

Herramienta de Mano / HAND TOOLS

Pinzas de presión
CR-MO Locking pliers
Mordaza curva 10"
CR-MO



PPC-10	AE14106		
EMPAQUE	PZAS.	PESO	GARANTÍA
Caballote	5/50	0,33 Kg	2 años

Pinzas de presión
CR-MO Locking pliers
Mordaza recta 10"
CR-MO



PPR-10	AE14107		
EMPAQUE	PZAS.	PESO	GARANTÍA
Caballote	5/50	0,33 Kg	2 años

Llave ajustable PERICO
Adjustable wrench
8"
Cr-V



PER-8	AE14102		
EMPAQUE	PZAS.	PESO	GARANTÍA
Caballote	5/50	0,25 Kg	2 años

Llave ajustable PERICO
Adjustable wrench
10"
Cr-V



PER-10	AE14101		
EMPAQUE	PZAS.	PESO	GARANTÍA
Caballote	5/50	0,40 Kg	2 años

Llaves combinadas estándar Cromo Vanadio

Standar Combined Wrenches Cr-V

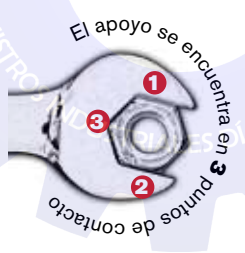

EMPAQUE	PZAS.	PESO	GARANTÍA
Caballote	6/36	0,04 Kg 0,39 Kg	2 años

ESTÁNDAR	
1/4"	LLC-250 AE14109
3/8"	LLC-385 AE14110
7/16"	LLC-437 AE14111
1/2"	LLC-500 AE14112
9/16"	LLC-562 AE14113
5/8"	LLC-625 AE14114
11/16"	LLC-687 AE14115
3/4"	LLC-750 AE14116
13/16"	LLC-812 AE14117
7/8"	LLC-875 AE14118
15/16"	LLC-937 AE14119

Llaves combinadas milimétricas Cromo Vanadio

Milimetric Combined Wrenches Cr-V



EMPAQUE	PZAS.	PESO	GARANTÍA
Caballote	6/36	0,07 Kg 0,22 Kg	2 años

MILIMÉTRICOS	
8 mm	LLC-8M AE14120
9 mm	LLC-9M AE14121
10 mm	LLC-10M AE14122
11 mm	LLC-11M AE14123
12 mm	LLC-12M AE14124
13 mm	LLC-13M AE14125
14 mm	LLC-14M AE14126
15 mm	LLC-15M AE14127
16 mm	LLC-16M AE14128
17 mm	LLC-17M AE14129
18 mm	LLC-18M AE14130
19 mm	LLC-19M AE14131





Juegos de Dados / TOOLS KITS

Con matraca
Socket set
1/2"
20 piezas

INCLUYE
9 dados estándar
9 dados milimétricos
1 extensión



JAC-1219	AE14060		
EMPAQUE	PZAS.	PESO	GARANTÍA
Blisters	5/10	1 Kg	1 año

Con matraca
Socket set
3/8"
22 piezas

INCLUYE
10 dados estándar
10 dados milimétricos
1 extensión



JAC-3821	AE14061		
EMPAQUE	PZAS.	PESO	GARANTÍA
Blisters	12	1.6 Kg	1 año

Kit de herramientas automotriz
Automotive tool set
140 piezas



KIT-3	AE14062		
EMPAQUE	PZAS.	PESO	GARANTÍA
Caja Color	4	4 Kg	6 meses

Kits de herramienta multipropósito / TOOLS KITS

7 PIEZAS



KHM-7	AE14196		
EMPAQUE	PZAS.	PESO	GARANTÍA
Estuche	1/20	1 Kg	1 año

15 PIEZAS



KHM-15	AE14195		
EMPAQUE	PZAS.	PESO	GARANTÍA
Estuche	1/20	1.5 Kg	1 año

22 PIEZAS



KHM-22	AE14194		
EMPAQUE	PZAS.	PESO	GARANTÍA
Portafolio	1/20	1.5 Kg	1 año

50 PIEZAS



KHPA-50	AE14198		
EMPAQUE	PZAS.	PESO	GARANTÍA
Estuche	1/10	7 Kg	1 año

141 PIEZAS



KHPA-141	AE14197		
EMPAQUE	PZAS.	PESO	GARANTÍA
Estuche	1/10	8 Kg	1 año

Paneles de Almacenamiento / Organización / PANELS

Con soporte para herramientas
Board panel
34 piezas
58.5 cm X 49.5 cm



PSH-34	AE18020		
EMPAQUE	PZAS.	PESO	GARANTÍA
Caja	1/6	3.8 Kg	1 año

(No incluye herramientas)

Con 16 gavetas
Board panel whit box's
17 piezas
47.5 cm X 49.5 cm



PG-17	AE18021		
EMPAQUE	PZAS.	PESO	GARANTÍA
Caja	1/6	2.3 Kg	1 año





desde 1960

Malacates / WIRE PULLERS

Tirford cable de acero incluido

Tirfor, steel cable included

1200 kg en arrastre
800 kg en vertical
Cable: Ø=8mm x 20 m



MCAT-1200 AE13003
EMPAQUE | PZAS. | PESO | GARANTÍA
Caja Color 1 14.8 Kg 6 meses

2400 kg en arrastre
1600 kg en vertical
Cable: Ø=11mm x 20 m



MCAT-2400 AE13004
EMPAQUE | PZAS. | PESO | GARANTÍA
Caja Color 1 27 Kg 6 meses

4000 kg en arrastre
3200 kg en vertical
Cable: Ø=16mm x 20 m



MCAT-4000 AE13005
EMPAQUE | PZAS. | PESO | GARANTÍA
Caja Color 1 56.8 Kg 6 meses

Tensores, reforzados para trabajos pesados

Heavy-duty tow ratchet

2 t



HP-2 AE13001
EMPAQUE | PZAS. | PESO | GARANTÍA
Caja Color 5 2.2 Kg 6 meses

4 t



HP-4 AE13002
EMPAQUE | PZAS. | PESO | GARANTÍA
Caja Color 4 2.35 Kg 6 meses

Tornillos de banco / BENCH VISES

Hierro Gris

Iron



Acero
Steel

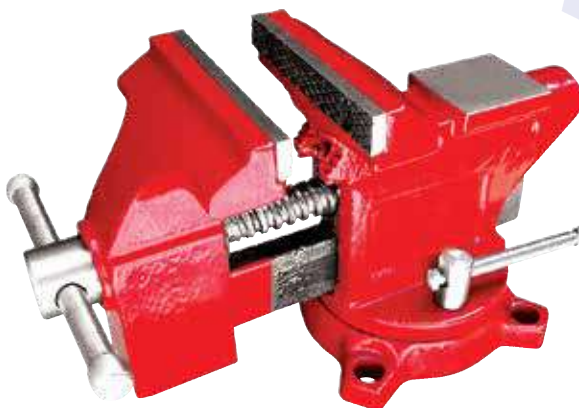

3.5" Apertura de mordaza: 3 1/2"
Ancho de Mordaza: 3 1/2"

TBA-3.5 AE25001
EMPAQUE | PZAS. | PESO | GARANTÍA
Caja 1 4.9 Kg 1 año

4" Apertura de mordaza: 4 1/4"
Ancho de Mordaza: 4"

TBA-4 AE25002
EMPAQUE | PZAS. | PESO | GARANTÍA
Caja 1 6.6 Kg 1 año

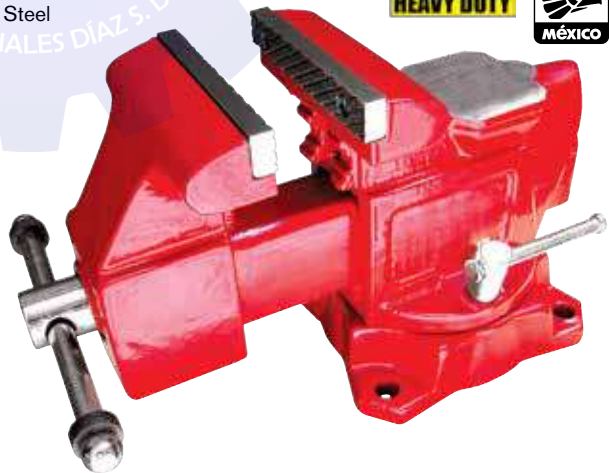

4" Apertura de mordaza: 3 1/2"
Ancho de Mordaza: 4"

TBH-4 AE25003
EMPAQUE | PZAS. | PESO | GARANTÍA
Caja 1 9.5 Kg 1 año

5" Apertura de mordaza: 5"
Ancho de Mordaza: 5"

TBH-5 AE25004
EMPAQUE | PZAS. | PESO | GARANTÍA
Caja 1 13.3 Kg 1 año

6" Apertura de mordaza: 5 1/2"
Ancho de Mordaza: 6"

TBH-6 AE25005
EMPAQUE | PZAS. | PESO | GARANTÍA
Caja 1 19.3 Kg 1 año

8" Apertura de mordaza: 8"
Ancho de Mordaza: 8"

TBH-8 AE25006
EMPAQUE | PZAS. | PESO | GARANTÍA
Caja 1 25 Kg 1 año





Maletas para herramientas / TOOL BAGS

Tipo diagonal

Diagonal tool bag

11 Compartimentos

Fabricada de poliamida
Dimensiones: 4 x 35 x 48 cm
Dimensions: 4 x 35 x 48 cm



MHD-13 AE18013

EMPAQUE	PZAS.	PESO	GARANTÍA
Caballote	24	0.4 Kg	6 meses

Tipo rectangular

Rectangular tool bag

5 Compartimentos

Correas de mano de gran resistencia.
Dimensiones: 35 X 13 x 17 cm.
High-resistance carrying straps
Dimensions: 35 X 13 x 17 cm



MH-5 AE18011

EMPAQUE	PZAS.	PESO	GARANTÍA
Caballote	48	0.33 Kg	6 meses

Tipo triangular

Triangular tool bag

17 Compartimentos

Correas de mano de gran resistencia
Fabricada de poliamida
Dimensiones: 27 X 56 x 25 cm
High-resistance carrying straps
Dimensions: 27 X 56 x 25 cm



MHG-16 AE18014

EMPAQUE	PZAS.	PESO	GARANTÍA
Caballote	18	1.3 Kg	6 meses

Tipo triangular con ruedas

Triangular tool bag with wheels

30 Compartimentos

Correas de mano y al hombro
Rueda de alta resistencia
Fabricada de poliamida
Dimensiones: 29 x 57 x 33 cm
Straps for hands and shoulder
High resistance wheel
Dimensions: 29 x 57 x 33 cm



MHCR-1 AE18012

EMPAQUE	PZAS.	PESO	GARANTÍA
Caballote	6	2.4 Kg	6 meses

Tipo triangular

Triangular tool bag

17 Compartimentos

Correas de mano de gran resistencia
Fabricada de poliamida
Dimensiones: 37 X 23 x 20 cm
High-resistance carrying straps
Dimensions: 37 X 23 x 20 cm



MH-17 AE18010

EMPAQUE	PZAS.	PESO	GARANTÍA
Caballote	24	0.6 Kg	6 meses

Multiherramientas / MULTITOOLS

Tijera multiusos

Multipurpose scissors

4 en 1



TMU-41 AE14108

EMPAQUE	PZAS.	PESO	GARANTÍA
Blister	6/24	0.1 Kg	6 meses

Con lámpara

With LED light

10 en 1



MHL-101 AE14086

EMPAQUE	PZAS.	PESO	GARANTÍA
Blister	22/44	0.1 Kg	6 meses





desde 1960

Multiherramientas / MULTITOOLS

Empaque de regalo

Gift Pack

9 en 1



MHER-91 AE14085

EMPAQUE	PZAS.	PESO	GARANTÍA
Blisters	12/48	0.2 Kg	6 meses

De bolsillo

Mini Pocket Multitool

10 en 1

Largo / Length: 2"
Incluye funda de nylon.
Includes nylon pouch.



MHB-101 AE14083

EMPAQUE	PZAS.	PESO	GARANTÍA
Blisters	12/48	0.2 Kg	6 meses

Multiusos

Multipurpose

13 en 1

Incluye

- 11 puntas destornilladoras
- 11 Bits



MH-131 AE14083

EMPAQUE	PZAS.	PESO	GARANTÍA
Blisters	20/80	0.1 Kg	6 meses



Multiusos

Multipurpose

15 en 1

Incluye

- 11 puntas destornilladoras
- 11 Bits



MH-151 AE14077

EMPAQUE	PZAS.	PESO	GARANTÍA
Blisters	14/56	0.2 Kg	6 meses



Multiusos

Multipurpose

28 en 1

Incluye

- 11 puntas destornilladoras
- 11 Bits



MH-281 AE14081

EMPAQUE	PZAS.	PESO	GARANTÍA
Blisters	12/24	0.4 Kg	6 meses



Kit para viaje

Travelling kit

23 en 1

Incluye:

- Navaja 6 en 1.



MHN-231 AE14089

EMPAQUE	PZAS.	PESO	GARANTÍA
Blisters	12/24	0.5 Kg	6 meses



Mango antiderrapante

Anti-slip Handle

14 en 1



MHMA-14 AE14087

EMPAQUE	PZAS.	PESO	GARANTÍA
Blisters	14/28	0.3 Kg	6 meses

Mango ergonómico

Ergonomic Handle

13 en 1



MHE-131 AE14084

EMPAQUE	PZAS.	PESO	GARANTÍA
Blisters	12/48	0.3 Kg	6 meses





Multiherramientas / MULTITOOLS

Mango de aluminio

Aluminum Handle

25 en 1

- Incluye:
•11 puntas
destornilladoras
•11 Bits



MHAL-25 AE14082

EMPAQUE	PZAS.	PESO	GARANTÍA
Blisters	12/24	0.34 Kg	6 meses



Mango de lujo

De luxe Handle

25 en 1

- Incluye:
•11 puntas
destornilladoras
•11 Bits



MHML-25 AE14088

EMPAQUE	PZAS.	PESO	GARANTÍA
Blisters	12/24	0.3 Kg	6 meses



Navaja Multisusos

Multipurpose Knife

27 en 1

Largo : 7"

- Incluye:
•Funda de nyló y 11 puntas
destornilladoras

Length: 7"

- Includes:
•Nylon pouch and
11 bits.



MH-271 AE14078

EMPAQUE	PZAS.	PESO	GARANTÍA
Blisters	6/24	0.4 Kg	6 meses

Navaja Multisusos

Multipurpose Knife

27 en 1

de Lujo

Largo : 7"

- Incluye:
•Funda de cuero y 11
puntas destornilladoras

Length: 7"

- Includes:
•Leather pouch and 11 bits



MH-271L AE14079

EMPAQUE	PZAS.	PESO	GARANTÍA
Blisters	6/12	0.45 Kg	6 meses

Kit multisusos navaja con lámpara

Multitool, knife and lamp kit

3 en 1

Incluye:

- Multiherramienta 15 en 1
- Navaja multisusos 15 en 1
- Lámpara con Led



KMNL-3 AE14072

EMPAQUE	PZAS.	PESO	GARANTÍA
Blisters	8/16	0.35 Kg	6 meses

Kit multisusos navaja con lámpara

Multitool, knife and lamp kit

4 en 1

Incluye:

- Multiherramienta 15 en 1
- Navaja multisusos 15 en 1
- Mini navaja 5 en 1
- Mini lámpara
- Baterías Incluidas



KML-41 AE14071

EMPAQUE	PZAS.	PESO	GARANTÍA
Blisters	6/24	0.4 Kg	6 meses

Navaja multisusos 13 en 1

13 in / multi use knife



NV-131 AB27027

EMPAQUE	PZAS.	PESO	GARANTÍA
Blisters	1/12	0.33 Kg	1 año

Kit navaja, brújula y lámpara

Switch blade, compass and lamp kit



KNBL-3 AE14073

EMPAQUE	PZAS.	PESO	GARANTÍA
Blisters	6/24	0.35 Kg	6 meses





Navajas / KNIFES

De bolsillo con luz
Mini pocket knife with light



Largo / length: 2.4"
Con luz integrada en el mango.
With integrated light.

NM-9	AE27010		
EMPAQUE	PZAS.	PESO	GARANTÍA
Blisters	100/400	0.3 Kg	6 meses

De bolsillo de lujo
Deluxe mini pocket knife



Largo / length: 2.6"

NML-8	AE27011		
EMPAQUE	PZAS.	PESO	GARANTÍA
Blisters	12/144	0.5 Kg	6 meses

Con mango antiderrapante
Non-slip grip pocket knife



Largo / length: 3.5"
Incluye funda de nylon
Includes nylon pouch

NA-4	AE27004		
EMPAQUE	PZAS.	PESO	GARANTÍA
Blisters	12/144	0.2 Kg	6 meses

Con mango metálico
Metallic grip pocket knife



Largo / length: 3.5"
Incluye funda de nylon
Includes nylon pouch

NAI-4	AE27005		
EMPAQUE	PZAS.	PESO	GARANTÍA
Blisters	12/144	0.1 Kg	6 meses

Con mango de madera
Wooden grip pocket knife



Largo / length: 4.5"
Incluye funda de nylon.
Includes nylon pouch.

NM-4	AE27009		
EMPAQUE	PZAS.	PESO	GARANTÍA
Blisters	12/144	0.2 Kg	6 meses

Navaja semiautomática de 3"
NEW!



NSA-3	AE14193		
EMPAQUE	PZAS.	PESO	GARANTÍA
Blisters	12	0.4 Kg	1 año

Multisusos

Multipurpose Knife

21 en 1



Largo / Length: 3.5"
Incluye funda de nylon.
Includes nylon pouch

NV-21	AE27013		
EMPAQUE	PZAS.	PESO	GARANTÍA
Blisters	12/96	0.2 Kg	6 meses

Multisusos

Multipurpose Knife

15 en 1



Largo / Length: 3.5"
Incluye funda de nylon.
Includes nylon pouch.

NA-151	AE27003		
EMPAQUE	PZAS.	PESO	GARANTÍA
Blisters	12/96	0.1 Kg	6 meses

Multisusos

Multipurpose Knife

8 en 1



Largo / Length: 3.5"
Incluye funda de nylon
Includes nylon pouch

NKV-81	AE27008		
EMPAQUE	PZAS.	PESO	GARANTÍA
Blisters	12/72	0.1 Kg	6 meses

Tipo Suiza

Swiss Army Knife

23 en 1



NASU-231	AE27006		
EMPAQUE	PZAS.	PESO	GARANTÍA
Blisters	10/20	0.5 Kg	6 meses

Tipo Suiza Kit

Swiss Army Knife Kit

15 en 1



KNASU-151	AE27002		
EMPAQUE	PZAS.	PESO	GARANTÍA
Blisters	12/48	0.3 Kg	6 meses





Línea **Seguridad Industrial**





Guantes de seguridad industrial / INDUSTRIAL SAFETY GLOVES

Guantes de Nylon calibre 13

Resistente a la abrasión totalmente cubierto con una capa de nitrilo azul y palma cubierta de nitrilo negro.

CHICOS
EPPG-1C GF06021

MEDIANOS
EPPG-1M GF06047

GRANDES
EPPG-1GR GF06048

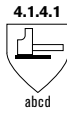

EMPAQUE	PZAS.	PESO	GARANTÍA
Caballote	12/120	0.1 Kg.	2 meses

Guantes de HPPE de alta visibilidad

Resistente al corte sumergido totalmente en nitrilo azul. Palma recubierta de nitrilo negro.

CHICOS
EPPG-2C GF06022

MEDIANOS
EPPG-2M GF06049

GRANDES
EPPG-2GR GF06050



EMPAQUE	PZAS.	PESO	GARANTÍA
Caballote	12/120	0.1 Kg.	2 meses

Guantes de Nylon

Palma recubierta de Poliuretano (PU) Color gris resistente a la abrasión.

EXTRA CHICOS
EPPG-3EC GF06071

CHICOS
EPPG-3C GF06023

MEDIANOS
EPPG-3M GF06051

GRANDES
EPPG-3GR GF06052

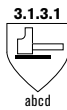

EMPAQUE	PZAS.	PESO	GARANTÍA
Caballote	12/120	0.1 Kg.	2 meses

Guantes resistente al corte con palma recubierta de carnaza

CHICOS
EPPG-4C GF06024

MEDIANOS
EPPG-4M GF06053

GRANDES
EPPG-4GR GF06054



EMPAQUE	PZAS.	PESO	GARANTÍA
Caballote	12/120	0.1 Kg.	2 meses

Guantes de alta visibilidad

Resiste a la abrasión y al corte

CHICOS
EPPG-5C GF06025

MEDIANOS
EPPG-5M GF06055

GRANDES
EPPG-5GR GF06056



EMPAQUE	PZAS.	PESO	GARANTÍA
Caballote	12/120	0.1 Kg.	2 meses

Guantes de Nitrilo con resistencia al corte

CHICOS
EPPG-7C GF06080

MEDIANOS
EPPG-7M GF06081

GRANDES
EPPG-7GR GF06082



EMPAQUE	PZAS.	PESO	GARANTÍA
Caballote	12/120	0.1 Kg.	2 meses

Guantes de Polietileno de alto desempeño

Resistente al corte y desgarre

CHICOS
EPPG-8C GF06028

MEDIANOS
EPPG-8M GF06057

GRANDES
EPPG-8GR GF06058



EMPAQUE	PZAS.	PESO	GARANTÍA
Caballote	12/120	0.1 Kg.	2 meses

Guantes de nitrilo resistentes a la abrasión

CHICOS
EPPG-9C GF06029

MEDIANOS
EPPG-9M GF06059

GRANDES
EPPG-9GR GF06060



EMPAQUE	PZAS.	PESO	GARANTÍA
Caballote	12/120	0.1 Kg.	2 meses





Guantes de seguridad industrial / INDUSTRIAL SAFETY GLOVES

Guantes resistentes al desgarre

CHICOS
EPPG-11C GF06030

MEDIANOS
EPPG-11M GF06061

GRANDES
EPPG-11GR GF06062



EMPAQUE	PZAS.	PESO	GARANTÍA
Caballote	12/120	0.1 Kg.	2 meses

Guantes de nylon con recubrimiento de nitrilo liso

CHICOS
EPPG-13C GF06031

MEDIANOS
EPPG-13M GF06063

GRANDES
EPPG-13GR GF06064



EMPAQUE	PZAS.	PESO	GARANTÍA
Caballote	12/120	0.1 Kg.	2 meses

Guantes de nitrilo con puño de seguridad

CHICOS
EPPG-14C GF06021

MEDIANOS
EPPG-14M GF06065

GRANDES
EPPG-14GR GF06066



EMPAQUE	PZAS.	PESO	GARANTÍA
Caballote	12/120	0.1 Kg.	2 meses

Guantes de nitrilo con puño de seguridad abierto

CHICOS
EPPG-15C GF06032

MEDIANOS
EPPG-15M GF06067

GRANDES
EPPG-15GR GF06068

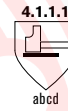

EMPAQUE	PZAS.	PESO	GARANTÍA
Caballote	12/120	0.1 Kg.	2 meses

Guantes de poliuretano con palma de nitrilo

Resiste a la abrasión y desgarre

CHICOS
EPPG-17C GF06077

MEDIANOS
EPPG-17M GF06078

GRANDES
EPPG-17GR GF06079

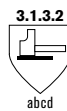

EMPAQUE	PZAS.	PESO	GARANTÍA
Caballote	12/120	0.1 Kg.	2 meses

Manga Kevlar

Con recubrimiento de Nitrilo en la palma

CHICOS
EPPG-19C GF06083

EMPAQUE	PZAS.	PESO	GARANTÍA
Caballote	12/120	0.1 Kg.	2 meses



Guantes de Kevlar con resistencia al corte

CHICOS
EPPG-20C GF06084

MEDIANOS
EPPG-20M GF06085

GRANDES
EPPG-20GR GF06086



EMPAQUE	PZAS.	PESO	GARANTÍA
Caballote	12/120	0.1 Kg.	2 meses

Guantes de látex

Resiste a la abrasión y desgarre

CHICOS
EPPG-21C GF06087

MEDIANOS
EPPG-21M GF06088

GRANDES
EPPG-21GR GF06089



EMPAQUE	PZAS.	PESO	GARANTÍA
Caballote	12/120	0.1 Kg.	2 meses

Guantes de seguridad industrial / INDUSTRIAL SAFETY GLOVES

Guantes de nylon y lycra con recubrimiento de nitrilo en la palma

Resiste a la abrasión



CHICOS EPPG-22C GF06090
MEDIANOS EPPG-22M GF06091
GRANDES EPPG-22GR GF06092

EMPAQUE	PZAS.	PESO	GARANTÍA
Caballote	12/120	0.1 Kg.	2 meses

Guantes de nylon con recubrimiento de nitrilo en la palma

Resiste a la abrasión



CHICOS EPPG-23C GF06093
MEDIANOS EPPG-23M GF06094
GRANDES EPPG-23GR GF06095

EMPAQUE	PZAS.	PESO	GARANTÍA
Caballote	12/120	0.1 Kg.	2 meses

Guantes de nylon con recubrimiento de nitrilo esponjoso en la palma

Resiste a la abrasión

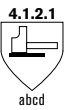

CHICOS EPPG-24C GF06096
MEDIANOS EPPG-24M GF06097
GRANDES EPPG-24GR GF06098

EMPAQUE	PZAS.	PESO	GARANTÍA
Caballote	12/120	0.1 Kg.	2 meses

Overol desechable polipropileno 25 grs



GRANDE EPP0-2G GF06123
EXTRA GRANDE EPP0-2XL GF06124

EMPAQUE	PZAS.	PESO	GARANTÍA
Caballote	12/120	0.1 Kg.	2 meses

Overol desechable polipropileno 60grs



GRANDE EPP0-1G GF06121
EXTRA GRANDE EPP0-1XL GF06122

EMPAQUE	PZAS.	PESO	GARANTÍA
Caballote	12/120	0.1 Kg.	2 meses

Guantes de Nitrilo Desechables NEW!



EPPG-22 GF06125

EMPAQUE	PZAS.	PESO	GARANTÍA
Caja Color	1/100	1 Kg.	N/A

Normativa EN 388:2003

Guantes para protección contra riesgos mecánicos

Esta norma establece los criterios para guantes de protección contra acciones físicas y mecánicas (abrasión, corte por cuchilla, desgarre y perforación).

El pictograma Riesgos Mecánicos se compone de un código de 4 dígitos que determinan el nivel de protección, cada uno corresponde a la capacidad de protección para un determinado riesgo.

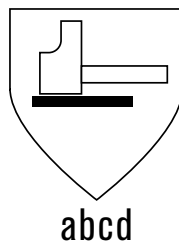

a. Resistencia a la abrasión.

Según el número de ciclos necesarios para desgastar completamente una muestra de guante.

b. Resistencia por cuchilla.

Según el número de ciclos necesarios para cortar completamente una muestra de guante, a una velocidad constante.

c. Resistencia al desgarre.

Según la fuerza necesaria para desgarrar una muestra de guante.

d. Resistencia a la perforación.

Según la fuerza necesaria para perforar una muestra de guante con un punzón normalizado.

Niveles o capacidad de protección donde "0" es siempre el nivel más bajo.

Prueba	Nivel de Protección					
	0	1	2	3	4	5
a. Resistencia a la abrasión (ciclos)	<100	100	500	2000	8000	
b. Resistencia al corte por cuchilla (factor)	<1.2	1.2	2.5	5	10	20
c. Resistencia al desgarre (Newton)	<10	10	25	50	75	
d. Resistencia a la perforación (newton)	<20	20	60	100	150	

Ejemplo:



Se interpreta

- a **Resistencia a la abrasión** 4 alto
- b **Resistencia al corte** 1 bajo
- c **Resistencia al desgarre** 3 Medio - alto
- d **Resistencia a la perforación** 1 Bajo



SUMINISTROS
INDUSTRIALES
DÍAZ

MIKEL'S



Línea **Industrial**



7821606595
7821604051
7821610766



contacto@sidadz.com



www.sidadz.com





desde 1960

Dobladoras para tubo / PIPE BENDERS

Hidráulica

Hidraulics

12 t



Incluye

- 6 dados de medidas / 6 sockets sizes: 1/2", 3/4", 1", 1 1/4", 1 1/2" y 2"
- Rodillos ajustables a medidas / Adjustable rollers: 8 1/2", 11", 14", 16 1/2", 19 1/4" y 22"

DTA-12 AF30001

EMPAQUE	PZAS.	PESO	GARANTÍA
Caja	1	32 kg	1 año

Hidráulica

Hidraulics

16 t



Incluye

- 8 dados de medias / 8 sockets sizes: 1/2", 3/4", 1", 1 1/2", 2", 2 1/2" y 3"
- Rodillos ajustables a medidas / Adjustable rollers: 8 9/16", 11 9/16", 14 7/16", 17 1/4", 20 1/8" y 23 1/8"

DTA-16 AF30002

EMPAQUE	PZAS.	PESO	GARANTÍA
Caja	1	64 kg	1 año

Neumática

Pneumatics

12 t



Incluye

- 6 dados de medidas / 6 sockets sizes: 1/2", 3/4", 1", 1 1/4", 1 1/2" y 2"
- Rodillos ajustables a medidas / Adjustable rollers: 8 1/2", 11", 14", 16 1/2", 19 1/4" y 22"

DTN-12 AF30005

EMPAQUE	PZAS.	PESO	GARANTÍA
Caja	1	45.5 kg	1 año

Neumática

Pneumatics

16 t



Incluye

- 8 dados de medias / 8 sockets sizes: 1/2", 3/4", 1", 1 1/2", 2", 2 1/2" y 3"
- Rodillos ajustables a medidas / Adjustable rollers: 8 9/16", 11 9/16", 14 7/16", 17 1/4", 20 1/8" y 23 1/8"

DTN-16 AF30006

EMPAQUE	PZAS.	PESO	GARANTÍA
Caja	1	69 kg	1 año

Horizontal Hidráulica

Hydraulics

12 t

Incluye dados de:

- 13mm (1/2")
- 19mm (3/4")
- 25mm (1/2")
- 31mm (1 1/4")
- 37mm (1 1/2")
- 50mm (2")



DTAH-12 AF30003

EMPAQUE	PZAS.	PESO	GARANTÍA
Caja	1	53 kg	1 año

Horizontal Hidráulica

Hydraulics

15 t

Incluye dados de:

- 13 mm (1/2")
- 9 mm (3/4")
- 25 mm (1/2")
- 31 mm (1 1/4")
- 37 mm (1 1/2")
- 50 mm (2")
- 64 mm (2 1/2")
- 75 mm (3")



DTAH-15 AF30004

EMPAQUE	PZAS.	PESO	GARANTÍA
Caja	1	109 kg	1 año

Gatos de uña / TOE JACKS

5 t

- Altura mínima de uña: 25 mm
- Altura máxima de uña: 230 mm
- Altura mínima y máxima de la cabeza: 368 - 573 mm
- Minimum toe height: 25 mm
- Maximum toe height: 230 mm
- Heads minimum and maximum height: 368- 573 mm



GU-5 AF17005

EMPAQUE	PZAS.	PESO	GARANTÍA
Caja	1	25 kg	1 año

10 t

- Altura mínima de uña: 30 mm
- Altura máxima de uña: 250 mm
- Altura mínima y máxima de la cabeza: 420 - 650 mm
- Minimum toe height: 30 mm
- Maximum toe height: 250 mm
- Heads minimum and maximum height: 420 - 650 mm



GU-10 AF17003

EMPAQUE	PZAS.	PESO	GARANTÍA
Caja	1	35 kg	1 año

25 t

- Altura mínima de uña: 58 mm
- Altura máxima de uña: 273 mm
- Altura mínima y máxima de la cabeza: 505 - 720 mm
- Minimum toe height: 58 mm
- Maximum toe height: 273 mm
- Heads minimum and maximum height: 505 - 720 mm



GU-25 AF17004

EMPAQUE	PZAS.	PESO	GARANTÍA
Caja	1	102 kg	1 año

Compacto

Compact

5 t

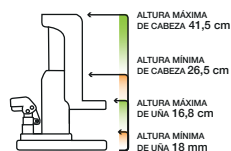

GHUC-5 AF17029

EMPAQUE	PZAS.	PESO	GARANTÍA
Caja de Madera	1	20.7	1 año

Compacto

Compact

10 t

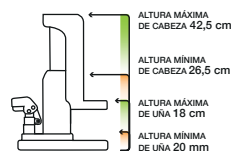

GHUC-10 AF17030

EMPAQUE	PZAS.	PESO	GARANTÍA
Caja de Madera	1	31	1 año





Gatos Mecánicos de Escalera / MECHANICAL JACKS

5 t

- Altura mínima de uña: 40 mm
- Altura máxima de uña: 385 mm
- Altura mínima y máxima de la cabeza: 725-1075 mm
- Minimum toe height: 40 mm
- Maximum toe height: 385 mm
- Heads minimum and maximum height: 725 - 1075 mm



GME-5	AF17002			
EMPAQUE	PZAS.	PESO	GARANTÍA	
Caja	1	33 kg	2 años	

10 t

- Altura mínima de uña: 40 mm
- Altura máxima de uña: 430 mm
- Altura mínima y máxima de la cabeza: 830-1220 mm
- Minimum toe height: 40 mm
- Maximum toe height: 430 mm
- Heads minimum and maximum height: 830 - 1220 mm



GME-10	AF17001			
EMPAQUE	PZAS.	PESO	GARANTÍA	
Caja	1	52 kg	2 años	

16 t

- Altura mínima de uña: 43 mm
- Altura máxima de uña: 430 mm
- Altura mínima y máxima de la cabeza: 830-1220 mm
- Minimum toe height: 43 mm
- Maximum toe height: 430 mm
- Heads minimum and maximum height: 830 - 1220 mm



GME-16	AF17006			
EMPAQUE	PZAS.	PESO	GARANTÍA	
Caja	1	70	1 año	

mikels.com.mx | f | @mikels tools

Pistones Hidráulicos / LONG RAM CYLINDERS

2" x 8"



PC-1	AF01004			
EMPAQUE	PZAS.	PESO	GARANTÍA	
Caja Color	1/2	7.9 kg	1 año	

2 1/2" x 8"



PC-2	AF01005			
EMPAQUE	PZAS.	PESO	GARANTÍA	
Caja Color	1/2	17 kg	1 año	

3" x 8"



PC-3	AF01006			
EMPAQUE	PZAS.	PESO	GARANTÍA	
Caja Color	1/2	23 kg	1 año	

3 1/2" x 8"



PC-4	AF01007			
EMPAQUE	PZAS.	PESO	GARANTÍA	
Caja Color	1/2	26.4 kg	1 año	

4" x 8"



PC-5	AF01008			
EMPAQUE	PZAS.	PESO	GARANTÍA	
Caja Color	1/2	36 kg	1 año	

MODELO / MODEL	PC-1	PC-2	PC-3	PC-4	PC-5
Presión / Pressure	2500 PSI (175 kg/cm ²)				
Medida / Size	2"	2 1/2"	3"	3 1/2"	4"
Recorrido / Stroke	8"				
Extensión Mín. / Min. Extension	20-14"				
Extensión Máx. / Max. Extension	28-14"				
Diámetro Pistón / Cylinder Ø	1 1/16"		1 1/4"		
Diámetro Perno / Screw Ø	1"				
Diámetro Cuerpo / Body Ø	2"	2 1/2"	3"	3 1/2"	4"

Mesas Elevadoras / SCISSORS LIFT TABLES

500 kg

Cubierta antiderrapante
Dos ruedas giratorias para fácil maniobrabilidad
Pedal de ascenso y descenso para fácil operación.

*Diamond table
Two casters for easy transport
Operated by foot pedal for easy operation.*



SP-500	AF01009			
EMPAQUE	PZAS.	PESO	GARANTÍA	
Caja Color	1	63.4 kg	1 año	

1 t

Cubierta antiderrapante
Dos ruedas giratorias para fácil maniobrabilidad
Pedal de ascenso y descenso para fácil operación.

*Diamond table
Two casters for easy transport
Operated by foot pedal for easy operation.*



SP-1000	AF01023			
EMPAQUE	PZAS.	PESO	GARANTÍA	
Caja Madera	1	210 kg	1 año	





desde 1960

Montacargas Hidráulicos / HYDRAULIC FORK LIFTS

Manual

Manual

1 t

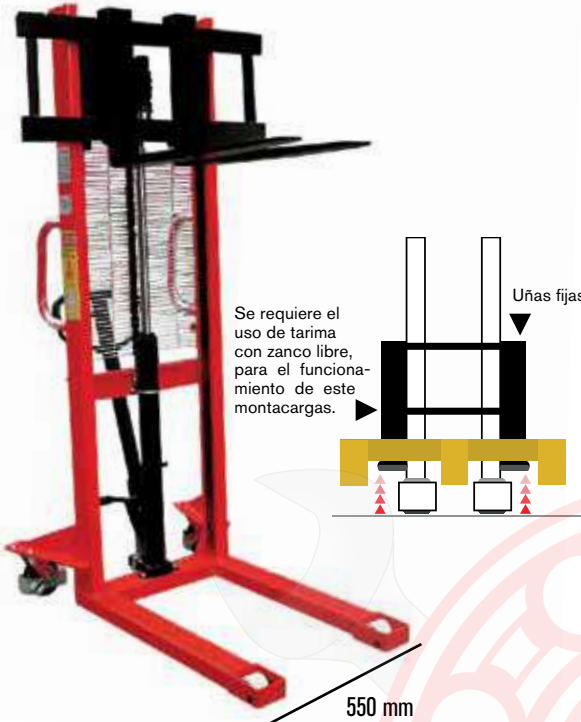

MH-1000 AF01001				
EMPAQUE	PZAS.	PESO	GARANTÍA	
Atado	1	250 kg	1 año	

Ancho Manual

Wide

1 t

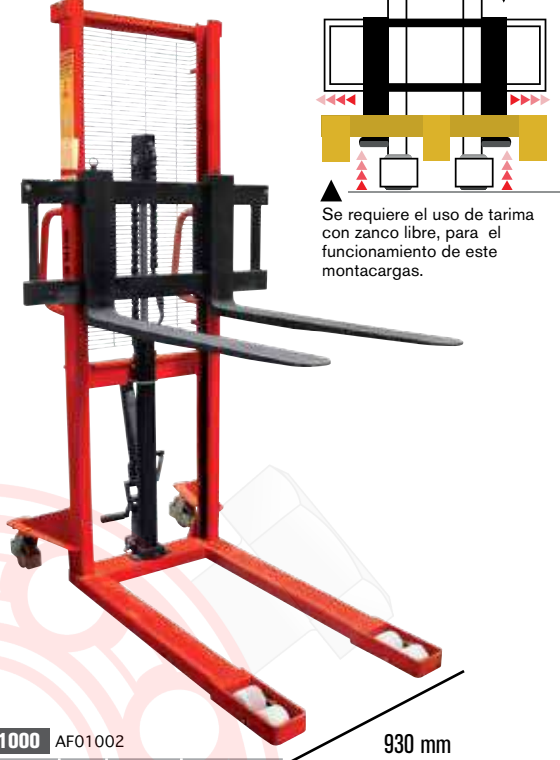

MHA-1000 AF01002				
EMPAQUE	PZAS.	PESO	GARANTÍA	
Atado	1	316 kg	1 año	

Extra Ancho Manual

Extra Wide

1 t

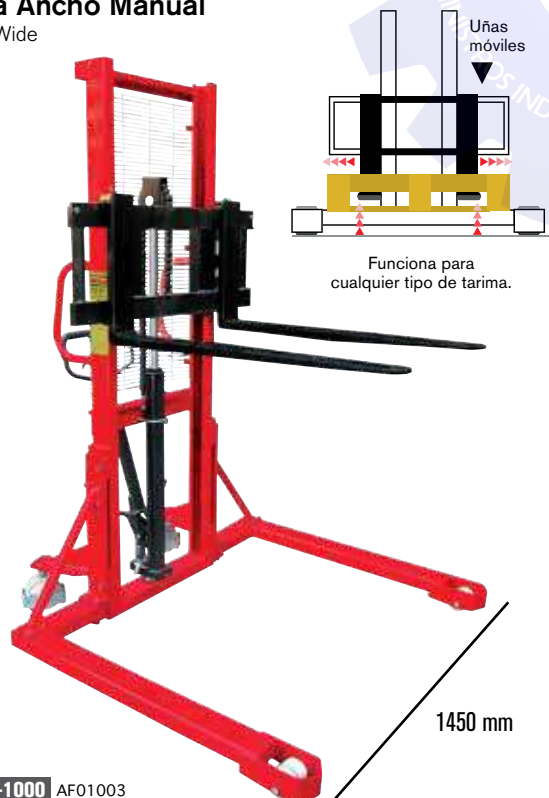

MHAA-1000 AF01003				
EMPAQUE	PZAS.	PESO	GARANTÍA	
Atado	1	336 kg	1 año	

Montacargas Semi-eléctrico

Semi-electric Fork Lift

1 t



ME-1000 AF15001				
EMPAQUE	PZAS.	PESO	GARANTÍA	
Atado	1	425 kg	1 año	





Montacargas Hidráulicos / HYDRAULIC FORK LIFTS

Montacargas Eléctrico de Escalón

Full Electric Stacker

2 t



MEJORADO

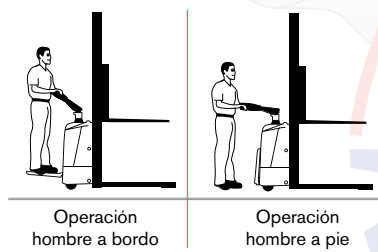
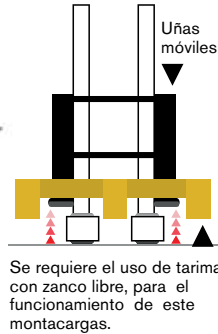

ME-2000	AF15002			
EMPAQUE	PZAS.	PESO	GARANTÍA	
Atado	1	750 kg	1 año	

Unidad de medida: METRO

Traspaleta Eléctrica

Electric pallet

2 t

- Batería Recargable
- Motor de Inducción alimentado por una batería de acumulación.
- Transmisión de engranes que facilita el desplazamiento de esta traspaleta.
- Ahorro en trabajo, alta eficiencia y estabilidad en la operación.
- Ruedas adicionales para agregar estabilidad y balance.



MEJORADO

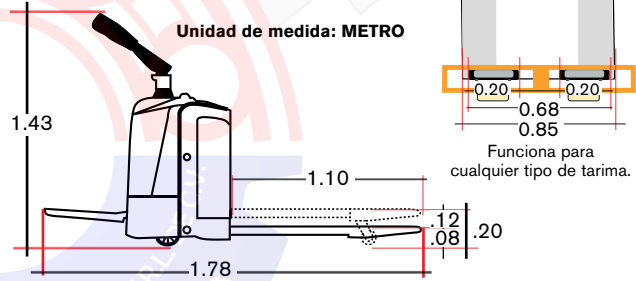

TEMK-2000	AF01024			
EMPAQUE	PZAS.	PESO	GARANTÍA	
Atado	1	100 kg	1 año	

MODELO / MODEL		MH - 1000	MHA - 1000	MHAA-1000	ME-1000	ME - 2000	TEMK-2000
Capacidad / Capacity	TON	1	1	1	1	2	2
Altura máxima de elevación / Maximum lift height	mm	1600	1600	1600	3000	3000	120
Altura mínima de uñas / Fork height, lowered	mm	90	90	70	90	90	80
Altura Total / Overall height	mm	2085	2085	2085	2090	2090	1430
Largo de uñas / Fork length	mm	800	1060	1060	1070	1070	1780
Ancho de uñas / Fork width	mm	100	100	100	170	170	685
Largo de soportes / Leg length	mm	860	860	1105	925	920	N/A
Ancho de soportes / Leg width	mm	550	930	1450	722	100	N/A
Distancia entre uñas / Inner distance between forks	mm	950	950	950	620	675	685
Diámetro de ruedas traseras / Diameter of rear wheels	mm	147	147	145	180	150	N/A
Diámetro de rueda de soporte / Diameter of leg's wheel	mm	83	83	79	79	80	N/A
Velocidad de elevación con carga /sin carga	m/s	25 mm/ciclo de bombeo	25 mm/ciclo de bombeo	25 mm/ciclo de bombeo	0.08 / 0.1	0.08 / 0.1	N/A
Velocidad de descenso con carga/sin carga	m/s	Manual	Manual	Manual	0.15/0.12	0.15/0.12	N/A
Diámetro de vuelta / Turning radius	mm	1235	1235	1200	1340	1730	1500
Capacidad de la batería / Battery capacity	A	N/A	N/A	N/A	200	240	240
Voltaje de la batería / Battery voltaje	v	N/A	N/A	N/A	12	24	24
Potencia del motor de elevación / Power of the lifting motor	KW	N/A	N/A	N/A	1.6	3	N/A

- Nuestros modelos de montacargas incluyen:**
- Protección y/o rejilla de seguridad para evitar accidentes en el descenso.
 - Agarraderas soldadas para facilitar la maniobrabilidad. (Excepto ME-2000)
 - Pedal para levantar la carga hidráulicamente. (Excepto Eléctricos)
 - Sistema de bloqueo en ambas ruedas para evitar movimientos no deseados.
 - Diseño compacto con sólida construcción de acero.
 - Brazos de soporte y mástil para lograr una flexión mínima, elevación segura y larga duración.
 - Sistemas de dirección manual simples y fáciles, equipados con freno de estacionamiento.
 - Control suave de elevación y descenso para obtener mayor precisión.
 - Ahorro, regeneración, seguridad y eficiencia de energía.
 - Se encuentran disponibles diseños especiales de acuerdo con los requisitos del cliente.

mikels.com.mx | Facebook | Instagram | YouTube | @mikels tools

Patines Hidráulicos / Traspaletas / PALLET TRUCKS

Ruedas de nylon sistema sencillo

Nylon wheels- single system

2.5 t



Ruedas de nylon

Sistema sencillo

Para todo tipo de pisos

TMK-2.5N	AF01015			
EMPAQUE	PZAS.	PESO	GARANTÍA	
Atado	1	61 kg	1 año	

Ruedas de nylon sistema tándem

Nylon wheels- tandem system

2.5 t



Ruedas de Nylon

Sistema Tandem

Para todo tipo de pisos

TMK-2.5NT	AF01016			
EMPAQUE	PZAS.	PESO	GARANTÍA	
Atado	1	63 kg	1 año	

Ruedas de poliuretano sistema tándem

PU wheels tandem system

2.5 t



Ruedas de Poliuretano

Sistema Tandem

Para pisos delicados

TMK-2.5	AF01014			
EMPAQUE	PZAS.	PESO	GARANTÍA	
Atado	1	64 kg	1 año	

Ruedas de poliuretano sistema tándem

PU wheels tandem system

3 t



Ruedas de Poliuretano

Sistema Tandem

Para pisos delicados

TMK-3	AF01017			
EMPAQUE	PZAS.	PESO	GARANTÍA	
Atado	1	83 kg	1 año	

Ruedas de poliuretano

PU wheels

1.5 t

Extrabaja



Ruedas de Acero

Sistema Tandem

Para todo tipo de pisos

TMK-1.5	AF01011			
EMPAQUE	PZAS.	PESO	GARANTÍA	
Atado	1	68 kg	1 año	

Ruedas de nylon

Nylon wheels

1.5 t

Extrabaja 4 way



Ruedas de Nylon

Sistema Tandem

Para todo tipo de pisos

TMK-1.54WEB	AF01013			
EMPAQUE	PZAS.	PESO	GARANTÍA	
Atado	1	101 kg	1 año	

Fácil acceso
Por cualquier lado de la tarime

Ruedas de Nylon

Nylon wheels

1.5 t

4 way

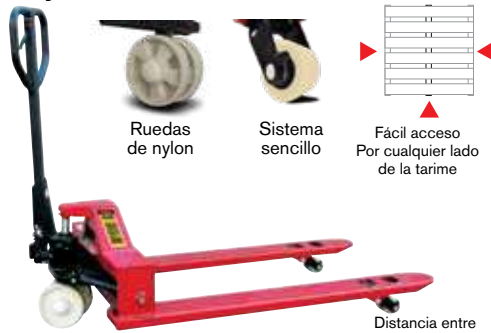

Ruedas de nylon

Sistema sencillo

Fácil acceso
Por cualquier lado de la tarime



TMK-1.54W	AF01012			
EMPAQUE	PZAS.	PESO	GARANTÍA	
Atado	1	98 kg	1 año	

Ruedas de Poliuretano

Pu wheels

2 t con báscula



Báscula electrónica con resolución de 1 Kg
Electronic scale with 1 Kg resolution.

Ruedas de Poliuretano

Sistema Tandem

TB-2000	AF01010			
EMPAQUE	PZAS.	PESO	GARANTÍA	
Atado	1	130 kg	1 año	



Patines Hidráulicos / Traspaletas / PALLET TRUCKS

Ruedas de poliuretano

PU wheels

1.5 t Telescópica



Ruedas de Poliuretano



Rango máximo de elevación: 80 cm

Para pisos delicados

TTMK-1.5 AF01022

EMPAQUE	PZAS.	PESO	GARANTÍA
Atado	1	55 kg	1 año

Ruedas de poliuretano tándem tipo europeo

Pu tandem wheels- european type

2.5 t

Uñas angostas y cortas tipo europeo

Narrow and short fork european type



Ruedas de Poliuretano

Sistema Tandem

Para pisos delicados

TMKE-2.5 AF01021

EMPAQUE	PZAS.	PESO	GARANTÍA
Atado	1	65 kg	1 año

Ruedas de nylon sistema tándem

Nylon wheels

3 t



Ruedas de Nylon

Sistema Tandem

TMK-3N AF01018

EMPAQUE	PZAS.	PESO	GARANTÍA
Atado	1	81 kg	1 año

Ruedas de nylon sistema tándem

Nylon wheels

5 t



Ruedas de Nylon

Sistema Tandem

TMK-5 AF01020

EMPAQUE	PZAS.	PESO	GARANTÍA
Atado	1	111 kg	1 año

Ruedas de nylon uñas extra largas sistema tándem

Nylon wheels

3 t

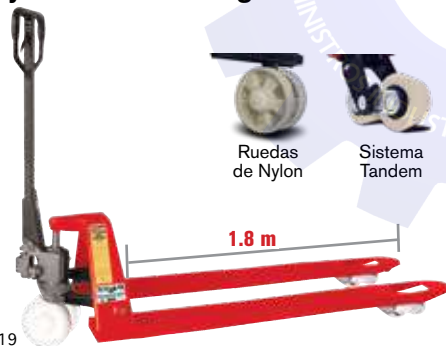

Ruedas de Nylon

Sistema Tandem

1.8 m

TMK-3XL AF01019

EMPAQUE	PZAS.	PESO	GARANTÍA
Atado	1	144 kg	1 año

Ruedas de nylon

Nylon wheels

2 t



Ruedas de Nylon

Sistema sencillo

TTN-02 BF01022

EMPAQUE	PZAS.	PESO	GARANTÍA
Atado	1	55 kg	1 año

MODELO / MODEL		TMK-2.5N	TMK-2.5NT	TMK-2.5	TMKE-2.5	TMK-3	TMK-3N	TMK-5	TMK-1.54W	TMK-1.54WEB	TMK-1.5	TTMK-1.5	TMK-3XL	TB-2000	TTN-2
Capacidad / Capacity	TON	2.5	2.5	2.5	2.5	3	3	5	1.5	1.5	1.5	1.5	3	2	2
Altura total de elevación / Total height of elevation	mm	200	200	200	200	195	195	195	200	196	142	800	195	175	190
Altura mínima de uñas / Forks' Minimum height	mm	85	85	85	85	75	75	77	85	52	52	85	75	85	75
Altura de estructura / Structure height	mm	422	422	422	422	422	422	422	422	422	399	432	422	539	390
Altura de manubrio / Handle height	mm	1224	1224	1224	1224	1222	1222	1222	1224	1224	1224	1224	1222	1220	1176
Ancho total de uñas / Overall fork width	mm	685	685	685	550	685	680	685	820	820	685	685	680	705	680
Distancia entre uñas / Distance Between forks	mm	365	365	365	230	365	365	365	510	510	510	365	365	405	380
Longitud de uñas / Fork length	mm	1220	1220	1220	1220	1220	1220	1220	1220	1220	1220	1150	1800	1150	1220
Longitud de sistema hidráulico / Length of hydraulic system	mm	300	300	300	300	300	300	300	300	300	300	300	300	418	470
Longitud Total / Overall Length		1520	1520	1520	1520	1520	1520	1520	1520	1520	1520	1520	2000	1568	1590
Diámetro de ruedas traseras / Diameter of rear wheel	mm	180	180	180	180	180	180	180	180	150	150	180	180	160	160
Diámetro de ruedas delanteras / Diameter of front wheel	mm	74	74	74	80	74	74	75	74	50	50	74	74	70	70





Polipastos / CHAIN HOISTS

Polipastos manuales, cadena de 3m, factor de seguridad 4:1

Chains of 3m Safety factor 4:1

500 kg

Columna de carga 1
Load chain 1



POLM-0.5 AF17011

EMPAQUE	PZAS.	PESO	GARANTÍA
Caja Color	1	9 kg	1 año

1 t

Columna de carga 1
Load chain 1



POLM-1 AF17012

EMPAQUE	PZAS.	PESO	GARANTÍA
Caja Color	1	9,16 kg	1 año

2 t

Columna de carga 2
Load chain 1



POLM-2 AF17014

EMPAQUE	PZAS.	PESO	GARANTÍA
Caja Color	1	12,5 kg	1 año

3 t

Columna de carga 2
Load chain 2



POLM-3 AF17015

EMPAQUE	PZAS.	PESO	GARANTÍA
Caja Color	1	22,5 kg	1 año

5 t

Columna de carga 2
Load chain 2



POLM-5 AF17016

EMPAQUE	PZAS.	PESO	GARANTÍA
Caja Color	1	34 kg	1 año

10 t

Columna de carga 4
Load chain 4



POLM-10 AF17013

EMPAQUE	PZAS.	PESO	GARANTÍA
Caja Color	1	68 kg	1 año

Polipastos de palanca, cadena de 1.50 m, factor de seguridad 4:1

Lever hoist



1.5 t

PDP-1.5 AF17007

EMPAQUE	PZAS.	PESO	GARANTÍA
Caja Color	1	12 kg	1 año

750kg

PDP-750 AF17010

EMPAQUE	PZAS.	PESO	GARANTÍA
Caja Color	1	7,1 kg	1 año

3 t

PDP-3 AF17008

EMPAQUE	PZAS.	PESO	GARANTÍA
Caja Color	1	19,1 kg	1 año

1 t

PDP-1 AF17006

EMPAQUE	PZAS.	PESO	GARANTÍA
Caja Color	1	7,2 kg	1 año

6 t

PDP-6 AF17009

EMPAQUE	PZAS.	PESO	GARANTÍA
Caja Color	1	28 kg	1 año





Polipastos / CHAIN HOISTS

MANUAL / Manual

1 t
CADENA DE 6 m **NEW!**

6 mm



PM-16 AF17031

EMPAQUE	PZAS.	PESO	GARANTÍA
Caja Madera	1	13.6 kg	1 año

2 t
CADENA DE 6 m **NEW!**

6 mm



PM-26 AF17032

EMPAQUE	PZAS.	PESO	GARANTÍA
Caja Madera	1	19 kg	1 año

3 t
CADENA DE 6 m **NEW!**

8 mm



PM-36 AF17033

EMPAQUE	PZAS.	PESO	GARANTÍA
Caja Madera	1	31.6 kg	1 año

ELÉCTRICOS / Electric

300 Kg
CADENA DE 3 m **NEW!**

5 mm



Sistema de freno de seguridad integrado

Ganchos de acero reforzado con sistema de cierre de seguridad

PEC-300 AF17034

EMPAQUE	PZAS.	PESO	GARANTÍA	CONEXIÓN
Caja Madera	1	31.6 kg	1 año	Contacto

mikels.com.mx | Facebook | Instagram | YouTube | @mikels tools



desde 1960

Polipastos Eléctricos / ELECTRIC CHAIN HOISTS

Eléctricos Electrics

400 kg
120 V / 60 Hz
850 W
cable Ø 3.8 mm
largo: 12 m



PE-400 AF17022

EMPAQUE	PZAS.	PESO	GARANTÍA	CONEXIÓN
Caja Color	2	16 kg	1 año	Contacto

600 kg
120 V / 60 Hz
1180 W
cable Ø 4.5 mm
largo: 12 m



PE-600 AF17023

EMPAQUE	PZAS.	PESO	GARANTÍA	CONEXIÓN
Caja Color	2	17.8 kg	1 año	Contacto

1 t
120 V / 60 Hz
1500 W
cable Ø 5.6 mm
largo: 12 m



PE-1000 AF17027

EMPAQUE	PZAS.	PESO	GARANTÍA	CONEXIÓN
Caja Color	1	30.5 kg	1 año	Contacto

1 t
220 V / 60 Hz
Trifásico
Eslabón 7.1 mm

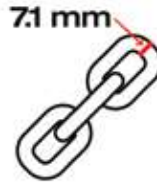

Cadena 3 m

PEC-1000 AF17028

EMPAQUE	PZAS.	PESO	GARANTÍA	CONEXIÓN
Caja Madera	1	53 kg	1 año	Contacto





Troles y Abrazaderas para Viga / CHAIN HOISTS

Troles, ancho ajustable

Trolleys
500 kg
75 mm-125 mm



TRV-0.5	AF17017			
EMPAQUE	PZAS.	PESO	GARANTÍA	
Caja Color	1	4.9 kg	1 año	

Troles, ancho ajustable

Trolleys
1 t
75 mm-125 mm



TRV-1	AF17018			
EMPAQUE	PZAS.	PESO	GARANTÍA	
Caja Color	1	6.8 kg	1 año	

Troles, ancho ajustable

Trolleys
2 t
100 mm
-150 mm



TRV-2	AF17019			
EMPAQUE	PZAS.	PESO	GARANTÍA	
Caja Color	1	10 kg	1 año	

Troles, ancho ajustable

Trolleys
3 t
100 mm-150 mm



TRV-3	AF17020			
EMPAQUE	PZAS.	PESO	GARANTÍA	
Caja Color	1	16 kg	1 año	

Troles, ancho ajustable

Trolleys
5 t
125 mm-175 mm



TRV-5	AF17021			
EMPAQUE	PZAS.	PESO	GARANTÍA	
Caja Color	1	30.8 kg	1 año	

Abrazadera

Beam clamp
2 t



AV-2	AF17024			
EMPAQUE	PZAS.	PESO	GARANTÍA	
Caja	1	5.3 kg	1 año	

Abrazadera

Beam clamp
3 t



AV-3	AF17025			
EMPAQUE	PZAS.	PESO	GARANTÍA	
Caja	1	10.7 kg	1 año	

Puede ser usado
como punto de
fijación



POLIPASTOS ELÉCTRICOS

MODELO / MODEL	POLM -05	POLM -1	POLM -2	POLM -3	POLM -5	POLM -10	PDP -750	PDP -1	PDP -1.5	PDP -3	PDP -6	PE -400	PE -600	PE -1000	PEC -1000	
Capacidad / Capacity	t	0.5	1.0	2.0	3.0	5.0	10.0	0.75	1.0	1.5	3.0	6.0	0.4	0.6	1	1
Altura de elevación / Lifting height	m	3.0	3.0	3.0	3.0	3.0	3.0	1.5	1.5	1.5	1.5	1.5	12.0	12.0		
Diámetro del eslabón de carga / Load chain link size	mm	6.0	6.0	6.0	8.0	10.0	10.0	6.3	6.3	7.1	9.0	9.0	3.8 *	4.5 *	5.7*	7.1

* Polipastos Eléctricos Ø del cable





Línea **Manufactura**

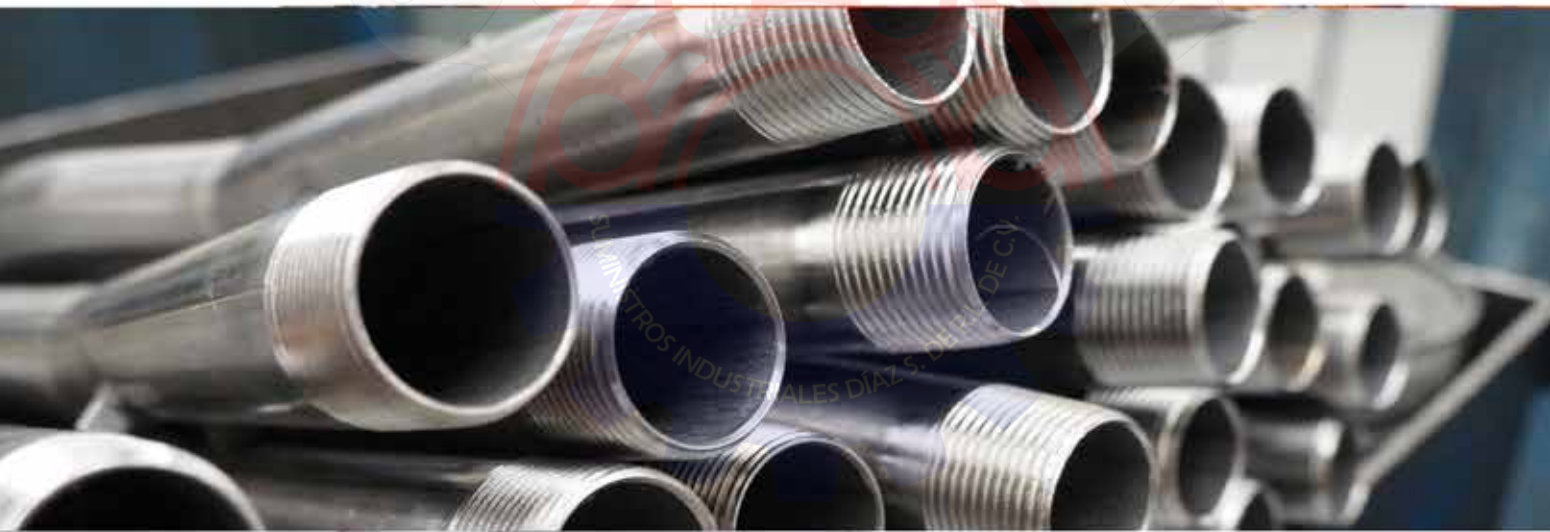



Manifolds

Calentadores de agua Water Heating



Aire acondicionado Air conditioner

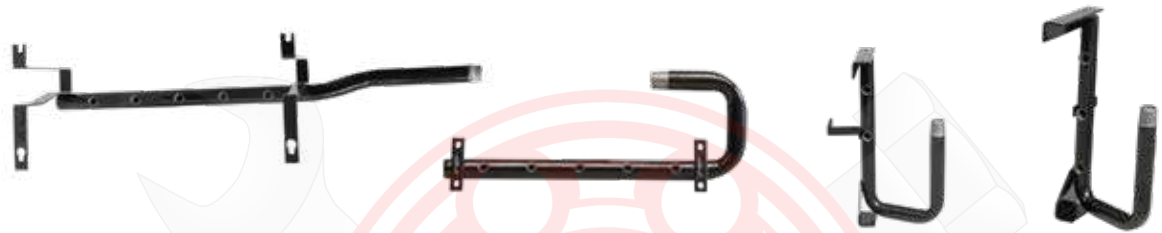

Equipo de cocción Manifolds for rangers / stoves /ovens





Línea



ORIGINAL EQUIPMENT MANUFACTURER



Línea OEM / LINE OEM

Motobomba para agua a gasolina motor 4 tiempos

Water pumps 4-stroke motor

5.5 HP

Salida 2"
Caudal de 500 L/min



USO AGRÍCOLA

MBOEM-2 NE11024

EMPAQUE	PZAS.	PESO	GARANTÍA
Caja	1	23 Kg	3 meses

Motobomba para agua a gasolina motor 4 tiempos

Water pumps 4-stroke motor

6.5 HP

Salida 3"
Caudal de 1000 L/min



USO AGRÍCOLA

MBOEM-3 NE11025

EMPAQUE	PZAS.	PESO	GARANTÍA
Caja	1	25 Kg	3 meses

Generador de corriente eléctrica motor 2 tiempos

Gasoline generators 2-stroke motor

900 W

120 Volts
2.7 Amperes
3600 RPM
Tanque de 4 l

Previo al llenado del tanque mezcla 4 litros de gasolina y 40 ml de aceite para motor de 2 tiempos.



GCOEM-900 AG32006

EMPAQUE	PZAS.	PESO	GARANTÍA
Caja Color	1	16.4 Kg	3 meses

Inyector de grasa

Grease Gun
3000 PSI
500 c.c

Incluye:
•Manguera
•Tubo rígido



IG/MG CA09001

EMPAQUE	PZAS.	PESO	GARANTÍA
Caja Color	20	1.6 Kg	3 meses

Bomba de aire para inflar llantas

Air Pump
120 PSI
Para válvula Americana



B/NM CE06001

EMPAQUE	PZAS.	PESO	GARANTÍA
Caballote	6	0.8 Kg	3 meses

Set de herramientas

Tool Set

133 PZS



KHOEM-133 EE14002

EMPAQUE	PZAS.	PESO	GARANTÍA
Portafolio	1/4	3.3 Kg	6 meses

Soldadora tipo inversor

Inverter welding machine

200 AMP



SOLOEM-200 ED29001

EMPAQUE	PZAS.	PESO	GARANTÍA
Caja Color	1	4 Kg	6 meses

Hidrolavadora de alta presión eléctrica motor de carbones

High pressure machine

1500 PSI

Incluye:
•Manguera de 5 m
•Cable de 3 m
•Pistola y Bayoneta



LP70-OEM ED04001

EMPAQUE	PZAS.	PESO	GARANTÍA
Caja Color	1	6 Kg	1 año

Gato hidráulico de patín

Hydraulic floor jack

2 t



GNM-2 CA01001

EMPAQUE	PZAS.	PESO	GARANTÍA
Caja Color	1	6.5 Kg	3 meses

Gato hidráulico de patín con portafolio

Hydraulic floor jack

2 t



GNM-2P CA01002

EMPAQUE	PZAS.	PESO	GARANTÍA
Portafolio	1	6.8 Kg	3 meses

Con Portafolio

mikels.com.mx | f | @mikels tools



Línea

Embellecimiento Automotriz



WOW!





Cepillo para limpieza chico
Car Brush. Small



Ideal para Limpiar Vestiduras

CLA-CH DA36004

EMPAQUE	PZAS.	PESO	GARANTÍA
Caballote	60	0.1 Kg.	3 meses

Máxima Limpieza a la carrocería

Cepillo para limpieza de llantas chico
Plastic Brush. Small



Logra una limpieza de llantas perfecta

CLL-CH DA36006

EMPAQUE	PZAS.	PESO	GARANTÍA
Caballote	60	0.2 Kg.	3 meses

Esponja para limpieza
Chenille Mitt



Para lavar todo el coche

ELA DA36008

EMPAQUE	PZAS.	PESO	GARANTÍA
Caballote	48	0.3 Kg.	3 meses

Esponja para limpieza
Sponge of PVA

- Absorbe 11 veces su peso
- No deja residuos
- Resistente a la grasa
- Sin pelusa que raye
- Hecha de polivinil acetato



ELA-1 DA36009

EMPAQUE	PZAS.	PESO	GARANTÍA
Caballote	288	0.1 Kg.	3 meses

Esponja multiusos
Sponge



Ideal para la aplicación en las llantas

EML DA36010

EMPAQUE	PZAS.	PESO	GARANTÍA
Caballote	150	0.1 Kg.	3 meses

Guante para limpieza
Chenille Mitt

- Cara de red con esponja.
- Cara de cerdas de algodón para un lavado suave.
- Resorte en la muñeca para ajuste perfecto.

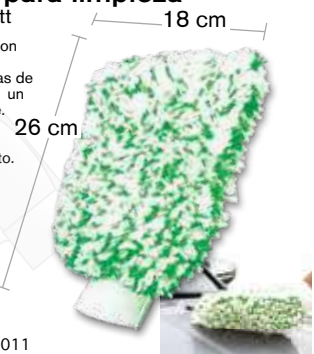

GLA DA36011

EMPAQUE	PZAS.	PESO	GARANTÍA
Caballote	24	0.1 Kg.	3 meses

Toalla de chamois
Chamois Towel

- Repelente a la pelusa
- Resiste grasa y/o aceite
- Ideal para todo tipo de limpieza
- Seca fácil y rápido

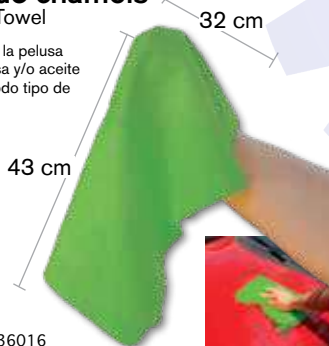

TCH-1 DA36016

EMPAQUE	PZAS.	PESO	GARANTÍA
Bote de plástico	100	0.1 Kg.	3 meses

Toalla de microfibra
Microfiber Towel

- Libre de pelusa
- 6 % más durable que las toallas normales.
- 3% más absorbente que la competencia.
- Secado más rápido
- No raya la pintura
- No absorbe olores



TMF-1 DA36017

EMPAQUE	PZAS.	PESO	GARANTÍA
Caballote	200	0.3 Kg.	3 meses

Cepillo para limpieza. Grande
Car Brush. Large



Ideal para limpieza de la carrocería

CLA DA36002

EMPAQUE	PZAS.	PESO	GARANTÍA
Blister	24	0.3 Kg.	3 meses

Cepillos para limpieza DUO PACK
Car Brush Set



CLA-DP DA36005

EMPAQUE	PZAS.	PESO	GARANTÍA
Blister	12	0.5 Kg	3 meses

Cepillo para limpieza de llantas. Grande
Plastic Brush. Large

- Cuerpo y cerdas de plástico
- Cerdas de 4 cm de longitud
- Ideal para lavado de llantas
- Excelente para lavar tapetes



Logra una limpieza de tapetes perfecta



Máxima Limpieza a las Llantas

CLL-G DA36007

EMPAQUE	PZAS.	PESO	GARANTÍA
Caballote	60	0.3 Kg.	3 meses

Mini jalador para limpieza
Squeegee

- Esponja súper absorbente
- Jalador muy resistente
- Cuerpo de plástico ABS



Ideal para limpieza de los cristales

Logra una limpieza perfecta

JLA-M DA36012

EMPAQUE	PZAS.	PESO	GARANTÍA
Caballote	50	0.2 Kg.	3 meses





Brillol, abrillantador de vinil
Vinyl shine

1 lts



BAV-1000 DA36001

EMPAQUE	PZAS.	PESO	GARANTÍA
Granel	6	1 Kg.	N/A

Shampoo para automóvil
Automotive Shampoo

1 lts



SPA-1000 DA36015

EMPAQUE	PZAS.	PESO	GARANTÍA
Granel	6	1 Kg.	N/A



Biodegradable

Limpiador de vestiduras biodegradable
Biodegradable Car seat cleaner

1 lts



Biodegradable

LDV-1000 DA36013

EMPAQUE	PZAS.	PESO	GARANTÍA
Granel	6	1 Kg.	N/A

Líquido limpiaparabrisas vidrios y cristales
Windshield and window glass cleaner

1 lts



LLP-1000 DA36014

EMPAQUE	PZAS.	PESO	GARANTÍA
Granel	6	1 Kg.	N/A

Línea de Aromatizantes / Air Fresheners



Pino



AW-P DA36020

EMPAQUE	PZAS.	PESO
Caballote	48/96	0.1 Kg

Limón



AW-L DA36022

EMPAQUE	PZAS.	PESO
Caballote	48/96	0.1 Kg

Vainilla



AW-V DA36023

EMPAQUE	PZAS.	PESO
Caballote	48/96	0.1 Kg

Fresa



AW-F DA36019

EMPAQUE	PZAS.	PESO
Caballote	48/96	0.1 Kg

Exhibidor WOW



- Incluye
- 1 exhibidor
 - 8 aromas distintos (10 pz de C/U)

Nieve



AW-B DA36025

EMPAQUE	PZAS.	PESO
Caballote	48/96	0.1 Kg

Manzana



AW-M DA36018

EMPAQUE	PZAS.	PESO
Caballote	48/96	0.1 Kg

Océano



AW-O DA36021

EMPAQUE	PZAS.	PESO
Caballote	48/96	0.1 Kg

Coco



AW-C DA36024

EMPAQUE	PZAS.	PESO
Caballote	48/96	0.1 Kg

EX-WOW DA36026

EMPAQUE	PZAS.	PESO	GARANTÍA
Bolsa	1/10	1.5 Kg	N/A





Exhibidores / FLOOR DISPLAYS

Para gatos de botella sin gatos



EX-1 AG32002

Con gatos hasta 20 t



EX-GG2 AG32021

Con gatos hasta 30 t



EX-GG1 AG32022

Para gatos de patín ligeros



EX-16 AG32004

Para gatos de patín Trabajo pesado



EX-2 AG32008

Para tornillos de banco con tornillos



EX-TOR AG32024

Para tornillos de banco sin tornillos



EX-TOR1 AG32025

Para porto powers



EX-3 AG32018

Para patines hidráulicos



EX-7 AG32019

Para pistones hidráulicos



EX-9 AG32020

Para carretes de manguera



EX-10 AG32001





desde 1960

Exhibidores / FLOOR DISPLAYS

Para torres para
automóvil



EX-18 AG32006

Para polipastos



EX-19 AG32007

Para compresores
de aire



EX-20 AG32009

Para dosificadores



EX-21 AG32010

Para generadores y
motobombas



EX-22 AG32011

Para plumas limpia
parabrisas



EX-23 AG32012

Para polipastos y troles



EX-29 AG32045

Metálico multiusos



EX-25 AG32014

Para tapetes



EX-33 AG32050





Artículos promocionales / PROMOTIONAL ITEMS

Etiqueta Máster
57.5 X 27 cm



AP-1 AG37005

Playera Polo



AP-2 AG37011

Exfoliador 2019



AP-3 AG37015

Gorra bordada



AP-4 AG37016

Gorra Dri-fit



AP-37 AG37033

Llavero Calibrador



AP-5 AG37017

Etiqueta logo 47 cm x 19 cm



AP-6 AG37018

Etiqueta logo 47 cm x 19 cm



AP-13 AG37004

Cenicero



AP-12 AG37003

Etiqueta para Cristales



AP-11 AG37002

Pluma

Tinta Negra



AP-8 AG37019

Auto pop exhibidor de cartón armado automático



AP-35 AG37031

Flexómetro promocional 1 metro



AP-24 AG37029

Chamarra



AP-14 AG37006

Mikcilindro 750 ml



MKC-750 AG37022

Bolsa con Ruedas



AP-15 AG37007

Multiherramienta 9 en 1



AP-19 AG37008

Gato Mini de aluminio



GPAM-60 AG37021

Camisa Racing



AP-20 AG37009

Navaja Multiusos 21 en 1



AP-21 AG37010

Bata para mostrador



AP-28 AG37012

Casaca para mostrador



AP-29 AG37013

Desarmador de Bolsillo 4 en 1



AP-30 AG37014

Tapete de PVC 60cmX90cm



AP-31 AG37025

Bolsa ecológica reciclable 25cmX31cm



AP-32 AG37026

Balón promocional



AP-36 AG32050

Llavero mini llave



AP-33 AG37027

AP-34 AG37028





Material punto de venta / Pop

Acrílico Exhibidor 60 x 90 cm



AP-22 AG32039

Mosaico para Fachadas 120 x 90 cm



AP-25 AG32040

Letrero Estireno Adherible 73 x 29 cm



AP-27 AG32042

Anuncio luminoso 92cm x 18cm x 28cm



EX-13 AG32037

Cenefa Mikel's



AP-16 AG32038

Lona distribuidor máster 120 cm x 240 cm



EX-11 AG32043

Antepecho PVC con logo 30 cm x 122 cm



POP-4 AG32030

Antepecho PVC con logo 30 cm x 244 cm



POP-5 AG32031

Escalón de madera 60 cm x 122 cm



POP-6 AG32032

Escalón de madera 60 cm x 244 cm



POP-7 AG32035

Exhibidor tipo Vitrina 3 vistas 2.44 m x 2.44 m



POP-12 AG32028

Vitrina Especial (Cualquier medida)



bajo pedido

Rotulación de Fachadas





**SUMINISTROS
INDUSTRIALES
DÍAZ**



**Av. Puebla 515
Col. Palma Sola, CP 93320
Poza Rica Veracruz, México**

Teléfonos

7821606595

7821604051

7821610766



www.sidiaz.com



Suministros Industriales Díaz



contacto@sidiaz.com



@SiDiazMex



@sidiazmex



Suministros Industriales Díaz