



**SUMINISTROS  
INDUSTRIALES  
DÍAZ**

# **CATÁLOGO**

# **ROLLWAY®**



**VISÍTENOS EN:**

*Av. Puebla 515 Col. Palma Sola, CP 93320.  
Poza Rica Veracruz, México*

**Teléfonos: 7821606595, 7821604051 y 7821610766**



[contacto@sidadz.com](mailto:contacto@sidadz.com)



[www.sidadz.com](http://www.sidadz.com)





Deep Groove Ball Bearing	Self-Aligning Ball Bearing	Angular Contact Ball Bearing	
Cylindrical Roller Bearing	Tapered Roller Bearing	Spherical Roller Bearing	
Thrust Ball Bearing	Spherical Roller Thrust Bearing	Accessories Adapter & Withdrawal Sleeve	Technical & Related Information

1 0 1 1 0 a

General index

### Deep Groove Ball Bearing

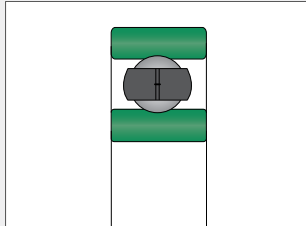

2 0 0 1 0 a

### Self-Aligning Ball Bearing

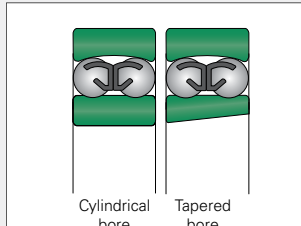

2 5 0 1 0 a

### Angular Contact Ball Bearing

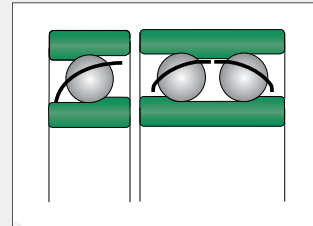

3 0 0 1 0 a

### Cylindrical Roller Bearing

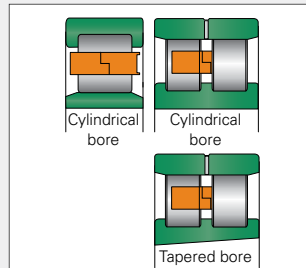

3 5 0 1 0 a

### Tapered Roller Bearing

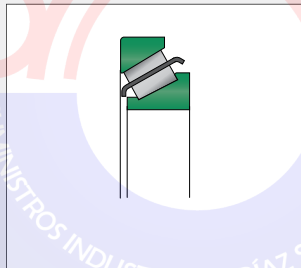

4 0 0 1 0 a

### Spherical Roller Bearing

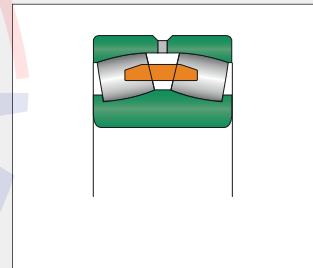

4 5 0 1 0 a

### Thrust Ball Bearing

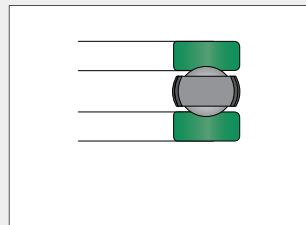

5 0 0 1 0 a

### Thrust Spherical Roller Bearing

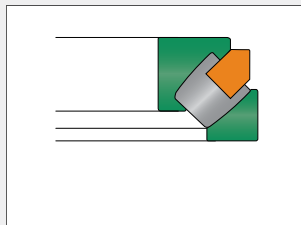

5 5 0 1 0 a

### Accessories Adapter Sleeve & Withdrawal Sleeve

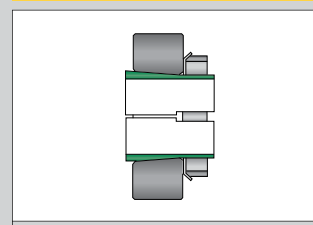

6 0 0 1 0 a



### Technical & Related Information

9 0 0 1 0 a



<b>Deep Groove Ball Bearing</b>	Self-Aligning Ball Bearing	Angular Contact Ball Bearing	
Cylindrical Roller Bearing	Tapered Roller Bearing	Spherical Roller Bearing	
Thrust Ball Bearing	Spherical Roller Thrust Bearing	Accessories Adapter & Withdrawal Sleeve	Technical & Related Information



# 20010a

## Single Row Deep Groove Ball Bearing

### Introduction



Click here for  
Technical & Related  
Information

The single row deep groove ball bearing is the most popular type of rolling bearing. Because the inner and outer raceway radii are only slightly larger than the ball diameter, it has considerable axial load carrying capacity in either direction, as well as radial loading. It is suitable for high speeds, and can be supplied with shields or seals - for example, suffix ZZ is added for shielded type, and suffix 2RS is added for sealed type.

The shielded types have a running clearance between the inner race and the metal shield; whereas, the sealed types (with seals made from synthetic rubber) make contact with the inner race. Both shielded and sealed bearings are supplied with the correct amount of lithium base grease, which has an operating temperature of -30 to +120°C (-22°F to +248°F).

Cages are normally two pieced pressed steel. For higher speeds, machined brass cages and reinforced plastics are used. Plastic cages are limited on operating temperature to about 120°C (248°F) maximum.

Deep Groove Ball Bearing can also be supplied with snap ring and groove, which provide a simple and space-saving means of locating the bearing in the housing. Bearings with this feature have the suffix NR added to the designation.

Dimensions in accordance with ISO 15:2011



### Standard

Open	ZZ 2 shields	2RS 2 seals	M

Brass cage  
 Steel cage

### Special versions

Z 1 shield	RS 1 seal	N circular groove for snap ring	ZZN 2 shields, circular groove for snap ring	ZNR 1 shield circular groove with snap ring	ZZNR 2 shields circular groove	ZN 1 shield circular groove for snap ring



<b>Deep Groove Ball Bearing</b>	Self-Aligning Ball Bearing	Angular Contact Ball Bearing	
Cylindrical Roller Bearing	Tapered Roller Bearing	Spherical Roller Bearing	
Thrust Ball Bearing	Spherical Roller Thrust Bearing	Accessories Adapter & Withdrawal Sleeve	Technical & Related Information



# 20100a

## Deep Groove Ball Bearing

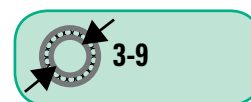
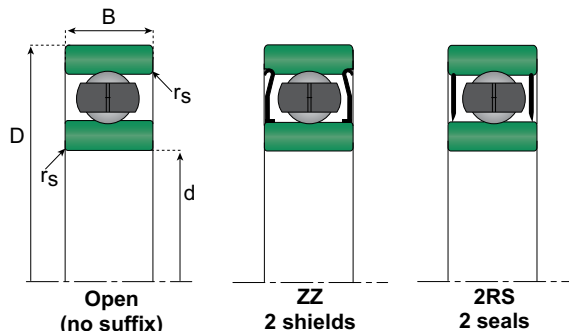

Click here for Technical & Related Information

Part number	Principal dimensions			Load ratings		Speed limits		Weight	Radius
	Bore	Outer	Width	Dynamic	Static	Grease	Oil		
	d	D	B	C	Co	rpm		Kg	rs min
mm									
kN									
1 min <sup>-1</sup>									
623	3	10	4	0,63	0,22	50000	60000	0,002	0,10
623 ZZ	3	10	4	0,63	0,22	50000		0,002	0,10
624	4	13	5	1,3	4,85	40000	48000	0,003	0,20
624 ZZ	4	13	5	1,3	4,85	40000		0,003	0,20
634	4	16	5	1,34	0,5	36000	43000	0,005	0,30
634 ZZ	4	16	5	1,34	0,5	36000		0,005	0,30
625	5	16	5	1,88	6,8	36000	43000	0,005	0,30
625 ZZ	5	16	5	1,88	6,8	36000		0,005	0,30
635	5	19	6	2,34	0,88	32000	40000	0,009	0,30
635 ZZ	5	19	6	2,34	0,88	32000		0,009	0,30
628/6 ZZ	6	13	5	1,08	0,44	40000	50000	0,003	0,15
626	6	19	6	2,34	0,88	32000	40000	0,008	0,30
626 ZZ	6	19	6	2,34	0,88	32000		0,008	0,30
626 2RS	6	19	6	2,34	0,88	22000		0,008	0,30
636	6	25	7	3,3	1,37	30000	36000	0,014	0,30
636 ZZ	6	25	7	3,3	1,37	30000		0,014	0,30
636 2RS	6	25	7	3,3	1,37			0,014	0,30
628/7 ZZ	7	14	5	1,17	0,51	40000	45000	0,003	0,15
607	7	19	6	2,34	0,88	36000	43000	0,008	0,30
607 ZZ	7	19	6	2,34	0,88	36000		0,008	0,30
607 2RS	7	19	6	2,34	0,88			0,008	0,30
627	7	22	7	3,3	1,37	30000	36000	0,013	0,30
637	7	26	9	4,56	1,98	28000	34000	0,024	0,30
637 ZZ	7	26	9	4,56	1,98	28000		0,024	0,30
637 2RS	7	26	9	4,56	1,98			0,024	0,30
608	8	22	7	3,3	1,37	34000	40000	0,012	0,30
608 ZZ	8	22	7	3,3	1,37	34000		0,012	0,30
608 2RS	8	22	7	3,3	1,37			0,012	0,30
628	8	24	8	3,35	1,43	28000	34000	0,017	0,30
628 ZZ	8	24	8	3,35	1,43	28000		0,017	0,30
628 2RS	8	24	8	3,35	1,43			0,017	0,30
638	8	28	9	4,55	1,97	28000	34000	0,028	0,30
638 ZZ	8	28	9	4,55	1,97	28000		0,028	0,30
609	9	24	7	3,35	1,43	32000	38000	0,014	0,30
609 ZZ	9	24	7	3,35	1,43	32000		0,014	0,30
609 2RS	9	24	7	3,35	1,43			0,014	0,30
629	9	26	8	4,55	1,97	28000	34000	0,019	0,30
629 ZZ	9	26	8	4,55	1,97	28000		0,019	0,30
629 2RS	9	26	8	4,55	1,97			0,019	0,30
639	9	30	10	4,65	2,07	24000	30000	0,35	0,60
639 ZZ	9	30	10	4,65	2,07	24000		0,35	0,60

Index other bore sizes

BEARING STEEL 100Cr6



STAINLESS STEEL



The bearings shown on this page have normal radial clearance according to ISO 5753-2009 and precision class according to ISO 492-2014 . For details and other radial clearances click the "Technical & Related Information" button.





<b>Deep Groove Ball Bearing</b>	Self-Aligning Ball Bearing	Angular Contact Ball Bearing	
Cylindrical Roller Bearing	Tapered Roller Bearing	Spherical Roller Bearing	
Thrust Ball Bearing	Spherical Roller Thrust Bearing	Accessories Adapter & Withdrawal Sleeve	Technical & Related Information



# 20100b

## Deep Groove Ball Bearing

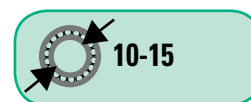
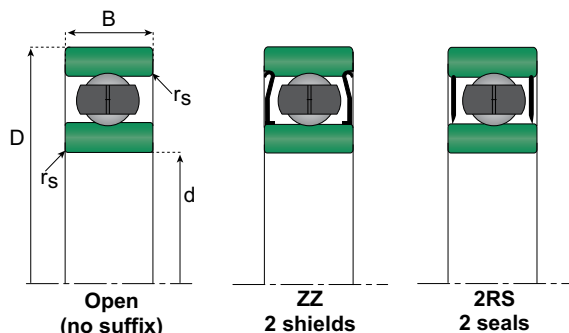

Click here for Technical & Related Information

Index other bore sizes

BEARING STEEL 100Cr6



STAINLESS STEEL



Part number	Principal dimensions			Load ratings		Speed limits		Weight	Radius
	Bore	Outer	Width	Dynamic	Static	Grease	Oil		
	d	D	B	C	Co	rpm		Kg	rs min
mm									
kN									
1 min <sup>-1</sup>									
61800	10	19	5	1,7	0,83	34000	40000	0,005	0,30
61800 ZZ	10	19	5	1,7	0,83	34000		0,005	0,30
61900	10	22	6	1,95	0,75	32000	38000	0,01	0,30
61900 ZZ	10	22	6	1,95	0,75	32000		0,01	0,30
6000	10	26	8	4,55	1,97	30000	36000	0,02	0,30
6000 ZZ	10	26	8	4,55	1,97	30000		0,02	0,30
6000 2RS	10	26	8	4,55	1,97			0,02	0,30
6200	10	30	9	5,1	2,39	24000	30000	0,032	0,60
6200 ZZ	10	30	9	5,1	2,39	24000		0,032	0,60
6200 2RS	10	30	9	5,1	2,39			0,032	0,60
6300	10	35	11	8,1	3,45	22000	26000	0,055	0,60
6300 ZZ	10	35	11	8,1	3,45	22000		0,055	0,60
6300 2RS	10	35	11	8,1	3,45			0,055	0,60
61801	12	21	5	1,8	0,95	32000	38000	0,006	0,30
61801 ZZ	12	21	5	1,8	0,95	32000		0,006	0,30
61901	12	24	6	2,9	1,45	30000	36000	0,011	0,30
61901 ZZ	12	24	6	2,9	1,45	30000		0,011	0,30
16001	12	28	7	5,1	2,37	28000	32000	0,026	0,30
6001	12	28	8	5,1	2,37	28000	32000	0,021	0,30
6001 ZZ	12	28	8	5,1	2,37	28000		0,021	0,30
6001 2RS	12	28	8	5,1	2,37			0,021	0,30
6201	12	32	10	6,8	3,05	22000	28000	0,038	0,60
6201 ZZ	12	32	10	6,8	3,05	22000		0,038	0,60
6201 2RS	12	32	10	6,8	3,05			0,038	0,60
6301	12	37	12	9,7	4,2	20000	24000	0,06	1,00
6301 ZZ	12	37	12	9,7	4,2	20000		0,06	1,00
6301 2RS	12	37	12	9,7	4,2			0,06	1,00
61802	15	24	5	2	1,25	28000	34000	0,007	0,30
61802 ZZ	15	24	5	2	1,25	28000		0,007	0,30
61902	15	28	7	4,35	2,26	26000	30000	0,017	0,30
61902 ZZ	15	28	7	4,35	2,26	26000		0,017	0,30
16002	15	32	8	5,6	2,83	24000	28000	0,037	0,30
6002	15	32	9	5,6	2,83	24000	28000	0,028	0,30
6002 ZZ	15	32	9	5,6	2,83	24000		0,028	0,30
6002 2RS	15	32	9	5,6	2,83	24000		0,028	0,30
6202	15	35	11	7,75	3,57	20000	24000	0,045	0,50
6202 ZZ	15	35	11	7,75	3,57	20000		0,045	0,50
6202 2RS	15	35	11	7,75	3,57	20000		0,045	0,50
6302	15	42	13	11,4	5,45	17000	20000	0,08	1,00
6302 ZZ	15	42	13	11,4	5,45	17000		0,08	1,00
6302 2RS	15	42	13	11,4	5,45			0,08	1,00

The bearings shown on this page have normal radial clearance according to ISO 5753-2009 and precision class according to ISO 492-2014 . For details and other radial clearances click the "Technical & Related Information" button.



<b>Deep Groove Ball Bearing</b>	Self-Aligning Ball Bearing	Angular Contact Ball Bearing	
Cylindrical Roller Bearing	Tapered Roller Bearing	Spherical Roller Bearing	
Thrust Ball Bearing	Spherical Roller Thrust Bearing	Accessories Adapter & Withdrawal Sleeve	Technical & Related Information



# 20100c

## Deep Groove Ball Bearing

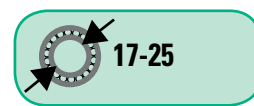
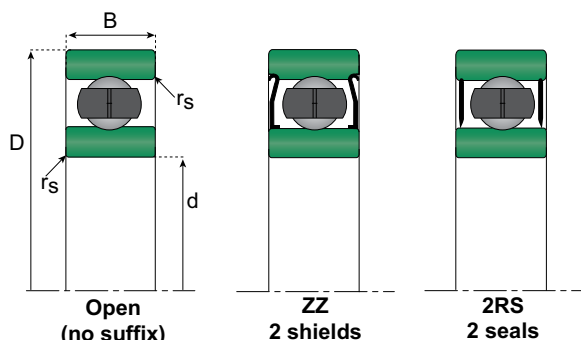

Click here for Technical & Related Information

Part number	Principal dimensions			Load ratings		Speed limits		Weight	Radius
	Bore	Outer	Width	Dynamic	Static	Grease	Oil		
	d	D	B	C	Co	rpm		Kg	rs min
mm									
kN									
1 min <sup>-1</sup>									
61803	17	26	5	2,2	1,4	26000	30000	0,009	0,30
61803 ZZ	17	26	5	2,2	1,4	26000		0,009	0,30
61903	17	30	7	4,35	2,3	24000	28000	0,018	0,30
61903 ZZ	17	30	7	4,35	2,3	24000		0,018	0,30
16003	17	35	8	6	3,25	22000	26000	0,04	0,30
6003	17	35	10	6	3,25	22000	26000	0,035	0,30
6003 ZZ	17	35	10	6	3,25	22000		0,035	0,30
6003 2RS	17	35	10	6	3,25			0,035	0,30
6203	17	40	12	9,55	4,8	17000	20000	0,066	0,60
6203 ZZ	17	40	12	9,55	4,8	17000		0,066	0,60
6203 2RS	17	40	12	9,55	4,8	17000		0,066	0,60
6303	17	47	14	13,6	6,65	15000	18000	0,11	1,00
6303 ZZ	17	47	14	13,6	6,65	15000		0,11	1,00
6303 2RS	17	47	14	13,6	6,65			0,11	1,00
61804	20	32	7	3,45	2,25	22000	26000	0,02	0,30
61804 ZZ	20	32	7	3,45	2,25	22000		0,02	0,30
61904	20	37	9	6,55	3,65	19000	22000	0,036	0,30
61904 ZZ	20	37	9	6,55	3,65	19000		0,036	0,30
16004	20	42	8	7,95	4,5	18000	20000	0,05	0,30
6004	20	42	12	9,4	5	18000	20000	0,063	0,60
6004 ZZ	20	42	12	9,4	5	18000		0,063	0,60
6004 2RS	20	42	12	9,4	5			0,063	0,60
6204	20	47	14	12,8	6,6	15000	18000	0,11	1,00
6204 ZZ	20	47	14	12,8	6,6	15000		0,11	1,00
6204 2RS	20	47	14	12,8	6,6			0,11	1,00
6304	20	52	15	15,9	7,9	14000	17000	0,14	1,10
6304 ZZ	20	52	15	15,9	7,9	14000		0,14	1,10
6304 2RS	20	52	15	15,9	7,9			0,14	1,10
61805	25	37	7	4,35	2,95	18000	22000	0,022	0,30
61805 ZZ	25	37	7	4,35	2,95	18000		0,022	0,30
61905	25	42	9	7	4,45	16000	19000	0,041	0,30
61905 ZZ	25	42	9	7	4,45	16000		0,041	0,30
16005	25	47	8	8,85	5,6	15000	18000	0,058	0,30
6005	25	47	12	10,1	5,85	15000	18000	0,08	0,60
6005 ZZ	25	47	12	10,1	5,85	15000		0,08	0,60
6005 2RS	25	47	12	10,1	5,85			0,08	0,60
6205	25	52	15	14	7,85	13000	15000	0,13	1,00
6205 ZZ	25	52	15	14	7,85	13000		0,13	1,00
6205 2RS	25	52	15	14	7,85	9750		0,13	1,00
6305	25	62	17	20,6	11,2	11000	13000	0,25	1,10
6305 ZZ	25	62	17	20,6	11,2	11000		0,25	1,10
6305 2RS	25	62	17	20,6	11,2			0,25	1,10
6405	25	80	21	37,2	18,7	9000	11000	0,058	1,50

Index other bore sizes

BEARING STEEL 100Cr6

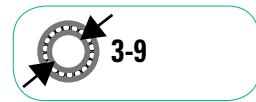

STAINLESS STEEL



The bearings shown on this page have normal radial clearance according to ISO 5753-2009 and precision class according to ISO 492-2014 . For details and other radial clearances click the "Technical & Related Information" button.





<b>Deep Groove Ball Bearing</b>	Self-Aligning Ball Bearing	Angular Contact Ball Bearing	
Cylindrical Roller Bearing	Tapered Roller Bearing	Spherical Roller Bearing	
Thrust Ball Bearing	Spherical Roller Thrust Bearing	Accessories Adapter & Withdrawal Sleeve	Technical & Related Information



# 20100d

## Deep Groove Ball Bearing

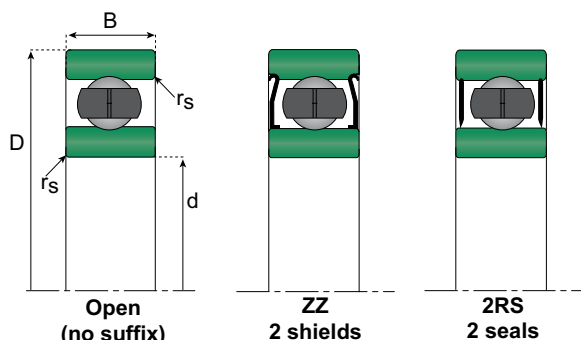

Click here for Technical & Related Information

Index other bore sizes

BEARING STEEL 100Cr6



STAINLESS STEEL



Part number	Principal dimensions			Load ratings		Speed limits		Weight	Radius
	Bore	Outer	Width	Dynamic	Static	Grease	Oil		
	d	D	B	C	Co	rpm		Kg	rs min
mm									
kN									
1 min <sup>-1</sup>									
61806	30	42	7	4,4	2,9	15000	18000	0,027	0,30
61906	30	47	9	7,8	4,7	14000	17000	0,045	0,30
16006	30	55	9	11,2	7,35	12000	15000	0,09	3,00
6006 ZZ	30	55	13	13,11	7,9	17000		0,12	1,00
6006 2RS	30	55	13	13,11	7,9	11900		0,12	1,00
6206	30	62	16	19,5	11,3	10000	13000	0,21	1,00
6206 ZZ	30	62	16	19,5	11,3	10000		0,21	1,00
6206 2RS	30	62	16	19,5	11,3	7500		0,21	1,00
62206 2RS	30	62	20	19,46	11,31	11000		0,25	1,00
6306	30	72	19	28,2	15,8	9000	11000	0,371	1,10
6306 ZZ	30	72	19	28,2	15,8	9000		0,371	1,10
6306 2RS	30	72	19	28,2	15,8	6000		0,371	1,10
6406	30	90	23	47,3	24,5	8500	10000	0,785	1,50
61807	35	47	7	4	3,25	13000	16000	0,031	0,30
61907	35	55	10	9,5	6,2	12000	14000	0,073	0,60
16007	35	62	9	12,2	8,85	10000	13000	0,11	0,30
6007	35	62	14	16	10,3	10000	13000	0,16	1,00
6007 2RS	35	62	14	15,9	10,3	7500		0,18	1,00
6207	35	72	17	25,7	15,4	9000	11000	0,315	1,10
6207 ZZ	35	72	17	25,7	15,4	9000		0,315	1,10
6207 2RS	35	72	17	25,7	15,4	6000		0,315	1,10
6307	35	80	21	33,5	18,3	8500	10000	0,45	1,50
6307 ZZ	35	80	21	33,5	18,3	8500		0,45	1,50
6307 2RS	35	80	21	33,5	18,3	5600		0,45	1,50
6407	35	100	25	55,5	29,4	7000	8500	0,954	1,50
61808	40	52	7	4,69	3,28	12000	14000	0,034	0,30
61908	40	62	12	14,5	10,2	11000	13000	0,11	0,60
16008	40	68	9	13,3	9,8	9500	12000	0,13	0,30
6008	40	68	15	16,8	11,6	9500	12000	0,21	1,00
6008 ZZ	40	68	15	16,8	11,6	9500		0,21	1,00
6008 2RS	40	68	15	16,8	11,6	6000		0,21	1,00
6208	40	80	18	32	17,8	8500	10000	0,402	1,10
6208 ZZ	40	80	18	32	17,8	8500		0,402	1,10
6208 2RS	40	80	18	32	17,8	5600		0,402	1,10
6308	40	90	23	40,7	24	7500	9000	0,635	1,50
6308 ZZ	40	90	23	40,7	24	7500		0,635	1,50
6308 2RS	40	90	23	40,7	24	5000		0,635	1,50
6408	40	110	27	64	36	6700	7500	1,23	2,00

The bearings shown on this page have normal radial clearance according to ISO 5753-2009 and precision class according to ISO 492-2014 . For details and other radial clearances click the "Technical & Related Information" button.



<b>Deep Groove Ball Bearing</b>	Self-Aligning Ball Bearing	Angular Contact Ball Bearing	
Cylindrical Roller Bearing	Tapered Roller Bearing	Spherical Roller Bearing	
Thrust Ball Bearing	Spherical Roller Thrust Bearing	Accessories Adapter & Withdrawal Sleeve	Technical & Related Information



# 20100e

## Deep Groove Ball Bearing

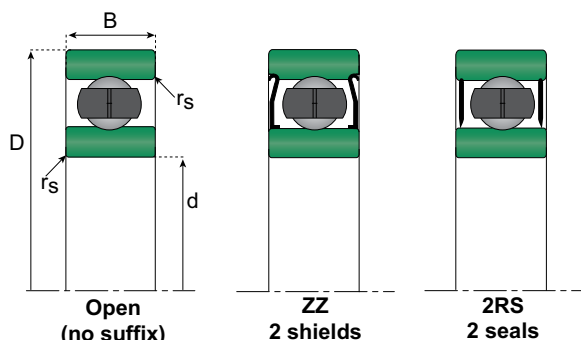

Click here for Technical & Related Information

Part number	Principal dimensions			Load ratings		Speed limits		Weight	Radius
	Bore	Outer	Width	Dynamic	Static	Grease	Oil		
	d	D	B	C	Co	rpm		Kg	rs min
mm									
kN									
1 min <sup>-1</sup>									
61809	45	58	7	6,4	5,6	9500	12000	0,043	0,30
61909	45	68	12	14	9,8	9700	11000	0,12	0,60
16009	45	75	10	15,5	12,3	9000	11000	0,17	0,60
6009	45	75	16	21	15	9000	11000	0,261	1,00
6009 ZZ	45	75	16	21	15	9000		0,261	1,00
6009 2RS	45	75	16	21	15	5600		0,261	1,00
6209	45	85	19	31,6	20,2	7500	9000	0,414	1,10
6209 ZZ	45	85	19	31,6	20,2	7500		0,414	1,10
6209 2RS	45	85	19	31,6	20,2	5300		0,414	1,10
6309	45	100	25	52,8	31,7	6700	8000	0,838	1,50
6309 ZZ	45	100	25	52,8	31,7	6700		0,838	1,50
6309 2RS	45	100	25	52,8	31,7	4500		0,838	1,50
6409	45	120	29	76,8	44,9	5600	6700	1,54	2,00
61810	50	65	7	6,8	6,3	9500	12000	0,06	0,30
61910	50	72	12	14,5	10,4	9000	11000	0,13	0,60
16010	50	80	10	16,3	13,1	8500	10000	0,19	0,60
6010	50	80	16	21,8	16,5	8500	10000	0,26	1,00
6010 ZZ	50	80	16	21,8	16,5	8500		0,26	1,00
6010 2RS	50	80	16	21,8	16,5	5300		0,26	1,00
6210	50	90	20	35,1	23,1	7000	8500	0,46	1,10
6210 ZZ	50	90	20	35,1	23,1	7000		0,46	1,10
6210 2RS	50	90	20	35,1	23,1	4500		0,46	1,10
6310	50	110	27	61,8	37,7	6000	7000	1,08	2,00
6310 ZZ	50	110	27	61,8	37,9	6000		1,06	2,00
6310 2RS	50	110	27	61,8	37,9	4000		1,06	2,00
6410	50	130	31	87,1	52	5000	6000	1,89	2,10
61811	55	72	9	9	8,5	8500	10000	0,08	0,30
16011	55	90	11	19,3	16,3	7500	9000	0,26	0,60
6011	55	90	18	28,3	21,2	7500	9000	0,39	1,10
6011 ZZ	55	90	18	28,3	21,2	7500		0,39	1,10
6011 2RS	55	90	18	28,3	21,2	4500		0,39	1,10
6211	55	100	21	43,4	29,3	6300	7500	0,61	1,50
6211 ZZ	55	100	21	43,4	29,3	6300		0,61	1,50
6211 2RS	55	100	21	43,4	29,3	4000		0,61	1,50
6311	55	120	29	71,5	44,6	5300	6300	1,38	2,00
6311 ZZ	55	120	29	71,5	44,6	5300		1,38	2,00
6311 2RS	55	120	29	71,5	44,6	3600		1,38	2,00
6411	55	140	33	100	62	4800	5600	2,3	2,10

Index other bore sizes

BEARING STEEL 100Cr6



STAINLESS STEEL

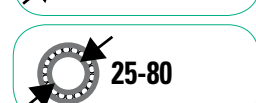

The bearings shown on this page have normal radial clearance according to ISO 5753-2009 and precision class according to ISO 492-2014 . For details and other radial clearances click the "Technical & Related Information" button.





<b>Deep Groove Ball Bearing</b>	Self-Aligning Ball Bearing	Angular Contact Ball Bearing	
Cylindrical Roller Bearing	Tapered Roller Bearing	Spherical Roller Bearing	
Thrust Ball Bearing	Spherical Roller Thrust Bearing	Accessories Adapter & Withdrawal Sleeve	Technical & Related Information

# 20100f

## Deep Groove Ball Bearing

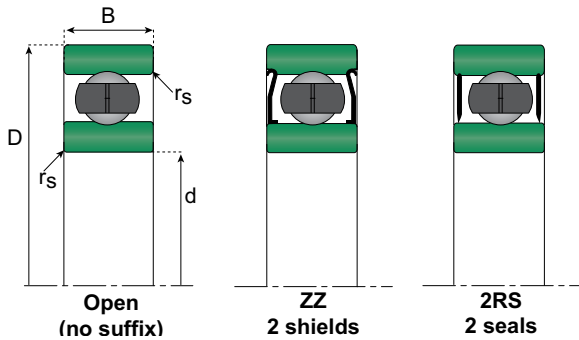

Click here for  
Technical & Related  
Information

Part number	Principal dimensions			Load ratings		Speed limits		Weight	Radius						
	Bore	Outer	Width	Dynamic	Static	Grease	Oil								
	d	D	B	C	Co	rpm		Kg	rs min						
mm										kN		1 min <sup>-1</sup>		mm	
61812	60	78	10	8,7	6,7	8000	9500	0,12	0,30						
16012	60	95	11	20	17,6	7000	8500	0,28	0,60						
6012	60	95	18	32	23,2	6700	8000	0,42	1,10						
6012 ZZ	60	95	18	32	23,2	6700		0,42	1,10						
6012 2RS	60	95	18	32	23,2	4300		0,42	1,10						
6212	60	110	22	52,4	36	6000	7000	0,78	1,50						
6212 ZZ	60	110	22	52,4	36	6000		0,78	1,50						
6212 2RS	60	110	22	52,4	36	4000		0,78	1,50						
6312	60	130	31	81,8	51,9	5000	6000	1,72	2,10						
6312 ZZ	60	130	31	81,8	51,9	5000		1,72	2,10						
6312 2RS	60	130	31	81,8	51,9	3400		1,72	2,10						
6412	60	150	35	110	70,8	4300	5000	2,76	2,10						
61813	65	85	10	12,2	12	7000	8500	0,13	0,60						
16013	65	100	11	22,9	19,6	6300	7500	0,3	0,60						
6013	65	100	18	31,9	25,2	6300	7500	0,44	1,10						
6013 ZZ	65	100	18	31,9	25,2	6300		0,44	1,10						
6013 2RS	65	100	18	31,9	25,2	4000		0,44	1,10						
6213	65	120	23	57,2	40	5300	6300	1	1,50						
6213 ZZ	65	120	23	57,2	40	5300		1	1,50						
6213 2RS	65	120	23	57,2	40	3600		1	1,50						
6313	65	140	33	92,7	59,7	4800	5600	2,1	2,10						
6313 ZZ	65	140	33	92,7	59,7	4800		2,1	2,10						
6313 2RS	65	140	33	92,7	59,7	3000		2,1	2,10						
6413	65	160	37	118	79	4000	4800	3,3	2,10						
61814	70	90	10	12,5	10	6700	8000	0,16	0,60						
61914 2RS	70	100	16	23,7	21,2	7700	6500	0,33	1,00						
16014	70	110	13	27,9	25	6000	7000	0,43	0,60						
6014	70	110	20	38,1	30,9	6000	7000	0,6	1,10						
6014 ZZ	70	110	20	38,1	30,9	6000		0,6	1,10						
6014 2RS	70	110	20	38,1	30,9	3600		0,6	1,10						
6214	70	125	24	62,2	44,1	5000	6000	1,07	1,50						
6214 ZZ	70	125	24	62,2	44,1	5000		1,07	1,50						
6214 2RS	70	125	24	62,2	44,1	3400		1,07	1,50						
6314	70	150	35	104	68,1	4500	5300	2,5	2,10						
6314 ZZ	70	150	35	104	68,1	4500		2,5	2,10						
6314 2RS	70	150	35	104	68,1	2800		2,5	2,10						
6414	70	180	42	144	104	3800	4500	4,85	3,00						

Index other bore sizes

BEARING STEEL 100Cr6



STAINLESS STEEL



The bearings shown on this page have normal radial clearance according to ISO 5753-2009 and precision class according to ISO 492-2014 . For details and other radial clearances click the "Related Information" button.



<b>Deep Groove Ball Bearing</b>	Self-Aligning Ball Bearing	Angular Contact Ball Bearing	
Cylindrical Roller Bearing	Tapered Roller Bearing	Spherical Roller Bearing	
Thrust Ball Bearing	Spherical Roller Thrust Bearing	Accessories Adapter & Withdrawal Sleeve	Technical & Related Information



# 20100h

## Deep Groove Ball Bearing

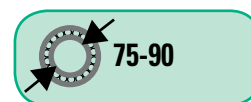
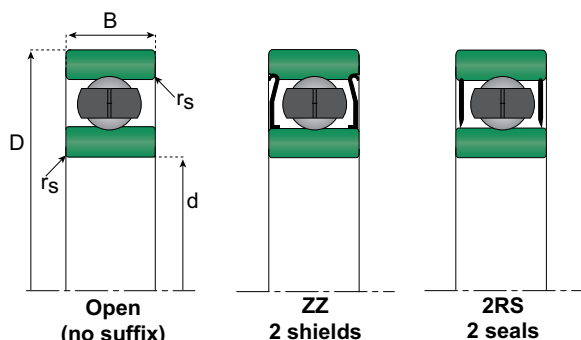

Click here for Technical & Related Information

Part number	Principal dimensions			Load ratings		Speed limits		Weight	Radius
	Bore	Outer	Width	Dynamic	Static	Grease	Oil		
	d	D	B	C	Co	rpm		Kg	rs min
mm			kN		1 min <sup>-1</sup>		mm		
16015	75	115	13	29	26,8	5600	6700	0,46	0,60
6015	75	115	20	39,7	33,5	5600	6700	0,64	1,10
6015 ZZ	75	115	20	39,7	33,5	5600		0,64	1,10
6015 2RS	75	115	20	39,7	33,5	3400		0,64	1,10
6215	75	130	25	67,4	49,3	4800	5600	1,18	1,50
6215 ZZ	75	130	25	67,4	49,3	4800		1,18	1,50
6215 2RS	75	130	25	67,4	49,3	3200		1,18	1,50
6315	75	160	37	113	77	4000	4800	3,03	2,10
6315 ZZ	75	160	37	113	77	4000		3,03	2,10
6315 2RS	75	160	37	113	77	2800		3,03	2,10
6415	75	190	45	154	115	3600	4300	6,5	3,00
61816	80	100	10	12,9	13,7	6000	7000	0,16	0,60
61916	80	110	16	25,1	20,5	5600	6700	0,38	1,00
16016	80	125	14	31,9	29,7	5300	6300	0,6	0,60
6016	80	125	22	47,6	39,8	5300	6300	0,85	1,10
6016 ZZ	80	125	22	47,6	39,8	5300		0,85	1,10
6016 2RS	80	125	22	47,6	39,8	3600		0,85	1,10
6216	80	140	26	71,45	53	4500	5300	1,4	2,00
6216 ZZ	80	140	26	71,45	53	4500		1,4	2,00
6216 2RS	80	140	26	71,45	53	3000		1,4	2,00
6316	80	170	39	123	86,5	3800	4500	3,6	2,10
6316 ZZ	80	170	39	123	86,5	3800		3,6	2,10
6416	80	200	48	164	125	3400	4000	7,5	3,00
61817	85	110	13	19,3	20	5300	6300	0,29	1,00
16017	85	130	14	33,8	33,5	5000	6000	0,63	1,00
6017	85	130	22	49,5	43,1	5000	6000	0,89	1,10
6017 ZZ	85	130	22	49,5	43,1	5000		0,89	1,10
6017 2RS	85	130	22	49,5	43,1	3400		0,89	1,10
6217	85	150	28	84	61,9	4300	5000	1,8	2,00
6217 ZZ	85	150	28	84	61,9	4300		1,8	2,00
6217 2RS	85	150	28	84	61,9	2800		1,8	2,00
6317	85	180	41	133	96,6	3600	4300	4,2	3,00
6317 ZZ	85	180	41	133	96,6	3600		4,2	3,00
6417	85	210	52	173	136	3200	3800	9	4,00
61818	90	115	13	19,6	20,4	5300	6300	0,3	1,00
16018	90	140	16	41,9	40,4	4500	5300	0,85	1,00
6018	90	140	24	58,2	49,7	4500	5300	1,16	1,50
6018 ZZ	90	140	24	58,2	49,7	4500		1,16	1,50
6018 2RS	90	140	24	58,2	49,7	3000		1,16	1,50
6218	90	160	30	96	71,5	3800	4500	2,16	2,00
6218 ZZ	90	160	30	96	71,5	3800		2,16	2,00
6218 2RS	90	160	30	96	71,5	3000		2,16	2,00
6318	90	190	43	143	107	3400	4000	4,9	3,00
6318 ZZ	90	190	43	143	107	3400		4,9	3,00
6418	90	225	54	190	160	3000	3600	11,5	4,00

Index other bore sizes

BEARING STEEL 100Cr6

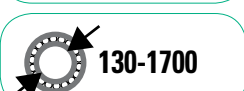
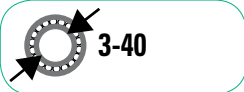

STAINLESS STEEL



The bearings shown on this page have normal radial clearance according to ISO 5753-2009 and precision class according to ISO 492-2014 . For details and other radial clearances click the "Related Information" button.





<b>Deep Groove Ball Bearing</b>	Self-Aligning Ball Bearing	Angular Contact Ball Bearing	
Cylindrical Roller Bearing	Tapered Roller Bearing	Spherical Roller Bearing	
Thrust Ball Bearing	Spherical Roller Thrust Bearing	Accessories Adapter & Withdrawal Sleeve	Technical & Related Information



Click here for  
Technical & Related  
Information

# 20100k

## Deep Groove Ball Bearing

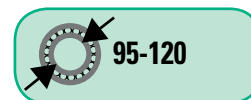
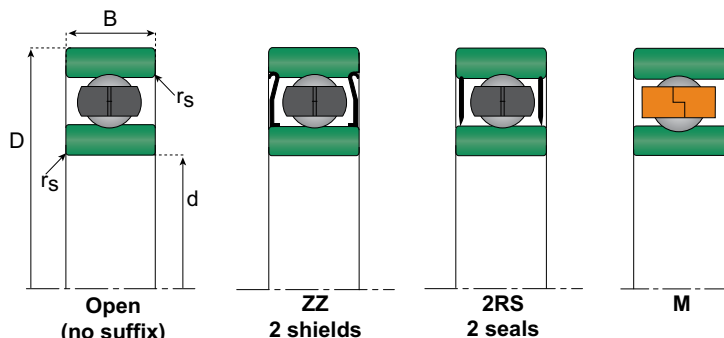

Part number	Principal dimensions			Load ratings		Speed limits		Weight	Radius
	Bore	Outer	Width	Dynamic	Static	Grease	Oil		
	d	D	B	C	Co	rpm		Kg	rs min
mm									
				kN		1 min <sup>-1</sup>			
16019	95	145	16	42,3	41,5	4300	5000	0,89	1,00
6019	95	145	24	60,5	53,6	4300	5000	1,2	1,50
6019 ZZ	95	145	24	60,5	53,6	4300		1,2	1,50
6019 2RS	95	145	24	60,5	53,6	2800		1,2	1,50
6219	95	170	32	109	81,9	3600	4300	2,6	2,10
6219 ZZ	95	170	32	109	81,9	3600		2,6	2,10
6319	95	200	45	153	118	3200	3800	5,6	3,00
61820	100	125	13	19,6	21,2	4800	5600	0,32	1,00
16020	100	150	16	45	44	4300	5000	0,91	1,00
6020	100	150	24	60,5	54	4300	5000	1,25	1,50
6020 ZZ	100	150	24	60,5	54	4300		1,25	1,50
6020 2RS	100	150	24	60,5	54	2800		1,25	1,50
6220	100	180	34	124	93	3400	4000	3,1	2,10
6220 ZZ	100	180	34	124	93	3400		3,1	2,10
6220 2RS	100	180	34	124	93	2500		3,1	2,10
6320	100	215	47	173	140	3000	3600	7	3,00
6320 ZZ	100	215	47	173	140	3000		7	3,00
16021	105	160	18	52	51	4000	4800	1,2	1,00
6021	105	160	26	72,3	65,8	3800	4500	1,6	2,00
6021 ZZ	105	160	26	72,3	65,8	3800		1,6	2,00
6221	105	190	36	133	104	3200	3800	3,7	2,10
6321	105	225	49	184	153	2800	3400	8	3,00
61822	110	140	16	28,1	29	4300	5000	0,6	1,00
61922	110	150	20	40,6	42	3600	4500	0,84	1,10
16022	110	170	19	57,5	56,7	3800	4500	1,46	1,00
6022	110	170	28	82	73	3600	4300	1,95	2,00
6022 ZZ	110	170	28	82	73	3600		1,95	2,00
6222	110	200	38	143	118	3000	3600	4,35	2,10
6222 ZZ	110	200	38	143	118	3000		4,35	2,10
6322	110	240	50	203	178	2600	3200	9,58	3,00
6322 M	110	240	50	204,5	177,2	2400	3200	11,2	3,00
61824	120	150	16	29,1	32,5	3800	4500	0,65	1,00
61924	120	165	22	53	54	3600	4300	1,21	1,10
16024	120	180	19	63,2	63,3	3400	4000	1,7	1,00
6024	120	180	28	88,48	79,3	3400	4000	2,09	2,00
6024 ZZ	120	180	28	88,48	79,3	3400		2,09	2,00
6024 2RS	120	180	28	85	79,3	2500		2,09	2,00
6224	120	215	40	155	131	2800	3400	5,15	2,10
6224 ZZ	120	215	40	155	131	2800		5,15	2,10
6324	120	260	55	212	190	2400	3000	13,6	3,00

Index other bore sizes

BEARING STEEL 100Cr6



STAINLESS STEEL



The bearings shown on this page have normal radial clearance according to ISO 5753-2009 and precision class according to ISO 492-2014 . For details and other radial clearances click the "Related Information" button.





<b>Deep Groove Ball Bearing</b>	Self-Aligning Ball Bearing	Angular Contact Ball Bearing	
Cylindrical Roller Bearing	Tapered Roller Bearing	Spherical Roller Bearing	
Thrust Ball Bearing	Spherical Roller Thrust Bearing	Accessories Adapter & Withdrawal Sleeve	Technical & Related Information



# 20100m

## Deep Groove Ball Bearing

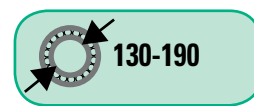
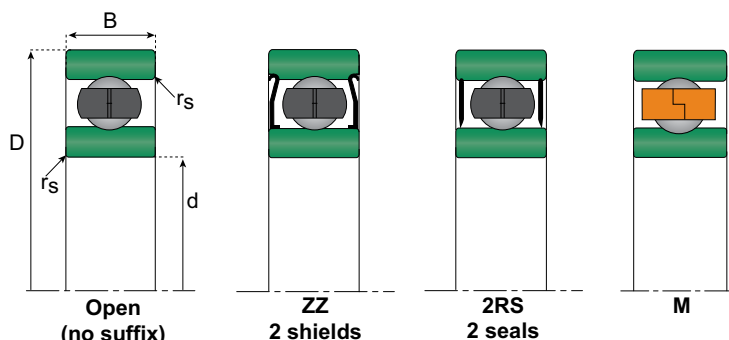

Click here for Technical & Related Information

Part number	Principal dimensions			Load ratings		Speed limits		Weight	Radius
	Bore	Outer	Width	Dynamic	Static	Grease	Oil		
	d	D	B	C	Co	rpm		Kg	rs min
mm									
kN									
1 min <sup>-1</sup>									
16026	130	165	18	38	43	3600	4300	0,93	1,10
61826	130	165	18	38	43	3600	4300	0,93	1,10
61926 M	130	180	24	65	67	3400	4000	1,92	1,50
6026	130	200	33	102,2	101	3000	3600	3,25	2,00
6026 ZZ	130	200	33	102,2	101	3000	3600	3,25	2,00
6226	130	230	40	167	146	2600	3200	6	3,00
6326	130	280	58	229	214	2200	2800	17	4,00
16028	140	210	22	80,5	86	2800	3400	2,7	1,10
6028	140	210	33	105,7	109	2800	3400	3,35	2,00
6028 ZZ	140	210	33	105,7	109	2800	3400	3,35	2,00
6228	140	250	42	176	164	2400	3000	7,5	3,00
6228 M	140	250	42	166	150	2400	300	9,44	3,00
6328	140	300	62	253	246	2000	2600	21	4,00
6328 M	140	300	62	273,5	272,5	2100	2500	21	4,00
61830	150	190	20	48,8	61	3000	3600	1,4	1,10
61930 M	150	210	28	84,5	90	2800	3400	3,04	2,00
16030	150	225	24	92,3	98	2600	3200	3,4	1,10
6030	150	225	35	125	126	2600	3200	4,75	2,10
6030 ZZ	150	225	35	125	126	2600	2600	4,75	2,10
6030 2RS	150	225	35	125	126	1950		4,7	2,10
6230	150	270	45	176	170	2000	2600	9,6	3,00
6330	150	320	65	275	284	1900	2400	25	4,00
61832	160	200	20	52	62	2800	3400	1,49	1,10
61932 M	160	220	28	90	95	2500	3100	3,15	2,00
16032	160	240	25	99,4	107	2400	3000	3,6	1,50
6032	160	240	38	140	143	2400	3000	5,85	2,10
6032 ZZ	160	240	38	140	143	2400		5,85	2,10
6232	160	290	48	185	186	1900	2400	15	3,00
6332 M	160	290	48	313	338,4	1900	2300	29,9	3,00
61934 M	170	230	28	115	100	2400	3000	5,19	2,00
16034	170	260	28	118	127	2200	2800	5,7	1,50
6034	170	260	42	168	172	2200	2800	7,8	2,10
6234	170	310	52	227	240	1900	2400	15,2	4,00
6234 M	170	310	52	227	240	1900	2400	18,4	4,00
61836	180	225	22	62,3	78,5	2400	3000	2	1,10
61936	180	250	33	128	137	2200	2800	4,9	2,00
16036 M	180	280	31	125	150	2000	2600	7,9	2,00
6036 M	180	280	46	195	202	2000	2600	10,7	2,10
6036	180	280	46	186	194	2000	2600	10,5	2,10
6236	180	320	52	227	242	1800	2200	18,5	4,00
61838	190	240	24	74,2	91,5	2200	2800	2,6	1,50
16038	190	290	31	148	162	2000	2600	7,9	2,00
6038	190	290	46	194	210	2000	2600	11	2,10
6238	190	340	55	255	278	1700	2000	23	4,00

Index other bore sizes

BEARING STEEL 100Cr6



STAINLESS STEEL



The bearings shown on this page have normal radial clearance according to ISO 5753-2009 and precision class according to ISO 492-2014 . For details and other radial clearances click the "Related Information" button.





<b>Deep Groove Ball Bearing</b>	Self-Aligning Ball Bearing	Angular Contact Ball Bearing	
Cylindrical Roller Bearing	Tapered Roller Bearing	Spherical Roller Bearing	
Thrust Ball Bearing	Spherical Roller Thrust Bearing	Accessories Adapter & Withdrawal Sleeve	Technical & Related Information



# 20100n

## Deep Groove Ball Bearing

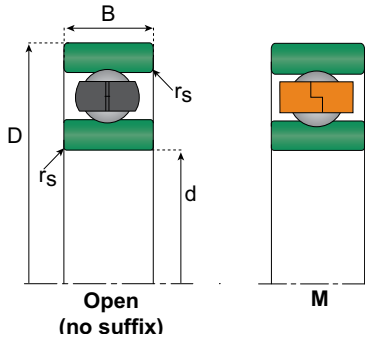

Click here for  
Technical & Related  
Information

Part number	Principal dimensions			Load ratings		Speed limits		Weight	Radius
	Bore	Outer	Width	Dynamic	Static	Grease	Oil		
	d	D	B	C	Co	rpm		Kg	rs min
mm									
kN									
1 min <sup>-1</sup>									
61840 M	200	250	24	74,2	84	2200	2800	2,68	1,50
61940 M	200	280	38	125	144	2000	2600	7,63	2,10
16040 M	200	310	34	160	179	1900	2400	10,3	2,00
6040 M	200	310	51	222	245	1900	2400	14,3	2,10
6240 M	200	360	58	288	335	1700	2000	24,4	4,00
61844 M	220	270	24	78,3	101,5	1900	2400	3,21	1,50
61944 M	220	300	38	175	162	1900	2400	8	2,10
16044	220	340	37	181	215	1800	2200	11,7	2,10
6044 M	220	340	56	245	293	1800	2200	18,8	3,00
6244	220	400	65	297	365	1500	1800	31,2	4,00
6344	220	460	88	403	520	1300	1600	71,4	5,00
6646 M	230	329,5	40	191	227	1600	2000	10,4	2,10
61848 M	240	300	28	103	116	1800	2200	4,78	2,00
61948 M	240	320	38	155	186	1800	2200	8,1	2,10
16048 M	240	360	37	188	228	1700	2000	15,8	2,10
6048 M	240	360	56	255	315	1700	2000	20,7	3,00
6248	240	440	72	360	470	1300	1600	51,8	4,00
61852 M	260	320	28	122	128	1700	2000	4,85	2,00
61952 M	260	360	46	212	269	1600	1900	14,4	2,10
16052 M	260	400	44	230	300	1500	1800	22	3,00
6052 M	260	400	65	294	375	1500	1800	28,8	4,00
61856 M	280	350	33	131	188	1600	1900	7,17	2,00
61956 M	280	380	46	215	282	1500	1800	15,6	2,10
16056	280	420	44	235	330	1300	1600	22,5	3,00
6056	280	420	65	305	405	1400	1700	32,2	4,00
6256	280	500	80	410	600	1000	1300	72	5,00
6356	280	580	108	560	840	1000	1200	141	6,00
61860 M	300	380	38	163	206	1400	1700	10,4	2,10
61960	300	420	56	267	370	1300	1600	20,7	3,00
6060	300	460	74	340	480	1200	1500	48,4	4,00
6260	300	540	85	450	665	950	1200	88	5,00
61864 M	320	400	38	164	220	1300	1600	11,4	2,10
60964	320	440	37	210	305	1200	1400	15,5	2,10
61964	320	440	56	278	395	1300	1600	24,9	3,00
16064	320	480	50	275	400	1100	1300	34	4,00
6064	320	480	74	355	510	1100	1400	50,3	4,00
6264	320	580	92	515	780	1000	1200	111	5,00
61868 M	340	420	38	169	227	1200	1500	11,6	2,10
61968 M	340	460	56	282	420	1100	1400	27	3,00
16068	340	520	57	335	520	950	1200	46	4,00
6068	340	520	82	403	620	1000	1300	63,4	5,00
6268	340	620	92	545	890	900	1000	112	6,00
60872	360	440	25	118	210	1130	1450	6,5	1,50
61872 M	360	440	38	182	290	1100	1400	12,2	2,10
61972 M	360	480	56	282	425	1100	1400	30,2	3,00
6072 M	360	530	82	355	620	1000	1300	59,8	5,00
16072	360	540	57	340	540	1000	1200	50	4,00

Index other bore sizes  
**BEARING STEEL 100Cr6**



**STAINLESS STEEL**



The bearings shown on this page have normal radial clearance according to ISO 5753-2009 and precision class according to ISO 492-2014 . For details and other radial clearances click the "Related Information" button.





<b>Deep Groove Ball Bearing</b>	Self-Aligning Ball Bearing	Angular Contact Ball Bearing	
Cylindrical Roller Bearing	Tapered Roller Bearing	Spherical Roller Bearing	
Thrust Ball Bearing	Spherical Roller Thrust Bearing	Accessories Adapter & Withdrawal Sleeve	Technical & Related Information



# 20100r

## Deep Groove Ball Bearing

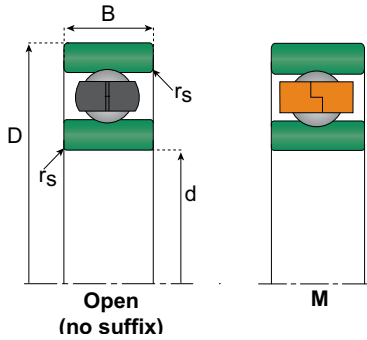

Click here for Technical & Related Information

Part number	Principal dimensions			Load ratings		Speed limits		Weight	Radius
	Bore	Outer	Width	Dynamic	Static	Grease	Oil		
	d	D	B	C	Co	rpm		Kg	rs min
mm									
kN									
1 min <sup>-1</sup>									
61876 MA	380	480	46	240	390	1000	1300	19	2,10
61976	380	520	65	345	550	1000	1300	39,8	4,00
16076	380	560	57	368	615	940	1100	50	4,00
60880	400	500	31	159	277	1000	1200	15	2,00
61880	400	500	46	242	403	1000	1200	21	2,10
60980	400	540	44	258	435	980	1250	27,5	3,00
61980	400	540	65	355	585	950	1200	43,6	4,00
6080 M	400	600	90	495	780	900	1100	87,9	5,00
61884	420	520	46	245	420	980	1250	21,5	2,10
61984 M	420	560	65	320	520	900	1100	46,2	4,00
6084	420	620	90	495	875	910	1110	90,5	5,00
60888	440	540	31	155	285	870	1000	16,5	2,00
61888 M	440	540	46	245	445	870	1000	22	2,10
60988	440	600	50	305	550	870	1000	41	4,00
61988 M	440	600	74	400	720	900	1100	59,2	4,00
6088	440	650	94	525	880	850	1000	108	6,00
61892 M	460	580	56	310	550	900	1100	34,3	3,00
61992	460	620	72	410	765	870	1100	63	4,00
61896	480	600	56	315	610	870	1100	36	3,00
6096	480	700	100	605	1130	740	900	126	6,00
608/500	500	620	37	220	445	800	950	20	2,10
618/500 M	500	620	56	330	620	800	950	37,3	3,00
619/500	500	670	78	450	860	760	900	79	5,00
60/500	500	720	100	575	1020	750	900	135	6,00
609/530	530	710	57	410	810	690	840	60	4,00
60/530	530	780	112	635	1260	670	810	188	6,00
608/560	560	680	37	220	460	710	860	30	2,10
618/560 M	560	680	56	328	525	700	850	42,7	3,00
608/600	600	730	42	260	550	670	800	41	3,00
618/600	600	730	60	345	710	670	800	52,7	3,00
608/630	630	780	48	355	765	640	760	41	3,00
609/630	630	850	71	475	1050	600	710	112	5,00
619/630	630	850	100	610	1330	600	710	163	6,00
60/630	630	920	128	800	1750	550	660	280	7,50
618/670	670	820	69	420	780	560	670	82,2	4,00
609/670	670	900	73	540	1210	580	700	143	5,00
619/670 M	670	900	103	670	1450	530	630	194	6,00
618/710	710	870	74	451	905	530	630	98,1	4
609/710	710	950	78	545	1280	500	610	148	5
619/710	710	950	106	645	1510	500	610	218	6
60/710	710	1030	140	935	2180	490	560	375	7,5
618/750	750	920	78	515	1240	480	610	110	5
619/750	750	1000	112	745	1790	490	570	260	6
60/750	750	1090	150	975	2370	450	530	490	7,5
608/800	800	980	57	390	990	430	510	100	4
618/800	800	980	82	545	1360	430	510	132	5
619/800	800	1060	115	815	2100	430	500	280	6
60/800	800	1150	155	985	2530	400	480	540	7,5
608/850	850	1030	57	385	1000	450	500	75	4
618/850	850	1030	82	555	1310	450	530	144	5
619/850	850	1120	118	815	2150	400	480	315	6
60/850	850	1220	165	1090	2980	370	430	640	7,5

Index other bore sizes  
BEARING STEEL 100Cr6



STAINLESS STEEL



The bearings shown on this page have normal radial clearance according to ISO 5753-2009 and precision class according to ISO 492-2014 . For details and other radial clearances click the "Related Information" button.





<b>Deep Groove Ball Bearing</b>	Self-Aligning Ball Bearing	Angular Contact Ball Bearing	
Cylindrical Roller Bearing	Tapered Roller Bearing	Spherical Roller Bearing	
Thrust Ball Bearing	Spherical Roller Thrust Bearing	Accessories Adapter & Withdrawal Sleeve	Technical & Related Information

# 20100s

## Deep Groove Ball Bearing

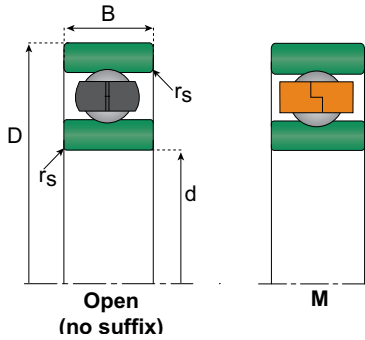

Click here for  
Technical & Related  
Information

Part number	Principal dimensions			Load ratings		Speed limits		Weight	Radius
	Bore	Outer	Width	Dynamic	Static	Grease	Oil		
	d	D	B	C	Co	rpm		Kg	rs min
mm									
kN									
1 min <sup>-1</sup>									
618/900 CA	900	1090	85	600	1430	380	450	155	5
619/900	900	1180	122	830	2270	360	440	355	6
60/900	900	1280	170	1080	3120	330	410	725	7,5
619/950	950	1250	132	985	2850	330	410	395	7,5
60/950	950	1360	180	1145	3315	310	380	850	7,5
608/1000 M	1000	1220	71	540	1550	350	400	175	4
618/1000 M	1000	1220	100	635	1720	340	400	230	5
609/1000	1000	1320	103	800	2340	330	380	405	6
619/1000	1000	1320	140	985	2880	330	380	525	7,5
60/1000	1000	1420	185	1320	3900	280	340	925	7,5
618/1060	1060	1280	100	710	2140	310	350	265	6
619/1060	1060	1400	150	985	3030	290	330	615	7,5
60/1060	1060	1500	195	1320	3860	250	330	1090	9,5
618/1120	1120	1360	106	725	2180	290	350	310	6
619/1120	1120	1460	150	1010	3070	270	330	640	7,5
60/1120	1120	1580	200	1430	4480	250	300	1245	9,5
619/1180	1180	1540	160	1115	3630	210	270	765	7,5
618/1250	1250	1500	112	830	2740	210	270	390	6
609/1320	1320	1720	128	1180	4060	190	230	835	7,5
618/1400	1400	1700	132	1070	3980	190	230	620	7,5
619/1400	1400	1820	185	1550	5520	180	230	1260	9,5
618/1500	1500	1820	140	1190	4310	170	210	695	7,5
619/1500	1500	1950	195	1680	6220	160	190	1515	9,5
618/1600	1600	1950	155	1240	4750	150	180	975	7,5
619/1600	1600	2060	200	1820	6880	140	170	1660	9,5
618/1700	1700	2060	160	1240	4950	130	160	1110	7,5

Index other bore sizes

BEARING STEEL 100Cr6



STAINLESS STEEL



The bearings shown on this page have normal radial clearance according to ISO 5753-2009 and precision class according to ISO 492-2014 . For details and other radial clearances click the "Related Information" button.



<b>Deep Groove Ball Bearing</b>	Self-Aligning Ball Bearing	Angular Contact Ball Bearing	
Cylindrical Roller Bearing	Tapered Roller Bearing	Spherical Roller Bearing	
Thrust Ball Bearing	Spherical Roller Thrust Bearing	Accessories Adapter & Withdrawal Sleeve	Technical & Related Information

# 20200a

## Deep Groove Ball Bearing - Stainless Steel

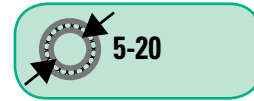
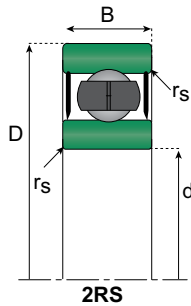

Click here for Technical & Related Information

[Index other bore sizes](#)

**STAINLESS STEEL**



**BEARING STEEL AISI 440C**



The bearings shown on this page have normal radial clearance according to ISO 5753-2009 and precision class according to ISO 492-2014. For details and other radial clearances click the "Related Information" button.

Part number	Principal dimensions			Load ratings		Speed limits	Weight	Radius
	Bore	Outer	Width	Dynamic	Static	Grease		
	d	D	B	C	C0	rpm	Kg	rs min
mm			kN		1 min <sup>-1</sup>	mm		
S685 2RS	5	11	3	0,72	0,28	43000	0,0011	0,15
S695 2RS	5	13	4	1,08	0,43	40000	0,0024	0,20
S605 2RS	5	14	5	1,33	0,51	39000	0,0035	0,20
S625 2RS	5	16	5	1,76	0,68	37000	0,0048	0,30
S635 2RS	5	19	6	2,34	0,89	34000	0,0080	0,30
S686 2RS	6	13	4	1,08	0,44	39000	0,0019	0,15
S696 2RS	6	15	5	1,35	0,53	37000	0,0038	0,20
S606 2RS	6	17	6	2,19	0,87	35000	0,0060	0,30
S626 2RS	6	19	6	2,34	0,89	34000	0,0080	0,30
S636 2RS	6	22	7	3,30	1,35	31000	0,0130	0,30
S687 2RS	7	14	4	1,17	0,51	37000	0,0021	0,15
S697 2RS	7	17	5	1,61	0,72	35000	0,0052	0,30
S607 2RS	7	19	6	2,24	0,91	34000	0,0080	0,30
S627 2RS	7	22	7	3,35	1,40	32000	0,0130	0,30
S637 2RS	7	26	9	4,55	1,95	26000	0,0240	0,30
S688 2RS	8	16	4	1,26	0,59	35000	0,0031	0,20
S698 2RS	8	19	6	1,99	0,87	33000	0,0073	0,30
S608 2RS	8	22	7	3,35	1,40	32000	0,0120	0,30
S628 2RS	8	24	8	4,00	1,59	31000	0,0170	0,30
S638 2RS	8	28	9	4,55	1,95	26000	0,0290	0,30
S689 2RS	9	17	4	1,72	0,82	33000	0,0032	0,20
S699 2RS	9	20	6	2,48	1,09	32000	0,0082	0,30
S609 2RS	9	24	7	3,40	1,45	31000	0,0140	0,30
S629 2RS	9	26	8	4,55	1,96	30000	0,0200	0,30
S639 2RS	9	30	10	6,00	2,65	24000	0,0350	0,30
S6800 2RS	10	19	5	1,83	0,93	32000	0,0050	0,30
S6900 2RS	10	22	6	2,70	1,27	30000	0,0090	0,30
S6000 2RS	10	26	8	4,55	1,96	29000	0,0190	0,30
S6200 2RS	10	30	9	5,10	2,39	25000	0,0320	0,60
S6300 2RS	10	35	11	8,20	3,50	23000	0,0530	0,60
S6801 2RS	12	21	5	1,92	1,04	29000	0,0060	0,30
S6901 2RS	12	24	6	2,89	1,46	27000	0,0110	0,30
S6001 2RS	12	28	8	5,10	2,39	26000	0,0210	0,30
S6201 2RS	12	32	10	6,10	2,75	22000	0,0370	0,60
S6301 2RS	12	37	12	9,70	4,20	20000	0,0600	1,00
S6802 2RS	15	24	5	2,08	1,26	26000	0,0070	0,30
S6902 2RS	15	28	7	4,10	2,06	24000	0,0160	0,30
S6002 2RS	15	32	9	5,60	2,84	22000	0,0300	0,30
S6202 2RS	15	35	11	7,75	3,60	19000	0,0450	0,60
S6302 2RS	15	42	13	11,40	5,45	17000	0,0820	1,00
S6803 2RS	17	26	5	2,81	1,72	24000	0,0080	0,30
S6903 2RS	17	30	7	4,65	2,58	22000	0,0180	0,30
S6003 2RS	17	35	10	6,80	3,35	20000	0,0390	0,30
S6203 2RS	17	40	12	9,60	4,60	18000	0,0660	0,60
S6303 2RS	17	47	14	13,50	6,55	16000	0,1150	1,00
S6804 2RS	20	32	7	4,00	2,47	21000	0,0190	0,30
S6904 2RS	20	37	9	6,40	3,70	19000	0,0360	0,30
S6004 2RS	20	42	12	9,40	5,05	18000	0,0690	0,60
S6204 2RS	20	47	14	12,80	6,65	16000	1,1060	1,00
S6304 2RS	20	52	15	15,90	7,90	14000	0,1440	1,10





<b>Deep Groove Ball Bearing</b>	Self-Aligning Ball Bearing	Angular Contact Ball Bearing	
Cylindrical Roller Bearing	Tapered Roller Bearing	Spherical Roller Bearing	
Thrust Ball Bearing	Spherical Roller Thrust Bearing	Accessories Adapter & Withdrawal Sleeve	Technical & Related Information



# 20200b

## Deep Groove Ball Bearing - Stainless Steel

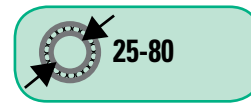
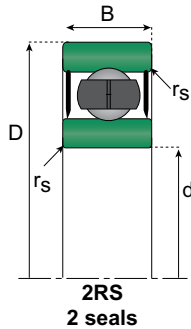

Click here for  
Technical & Related  
Information

[Index other bore sizes](#)

**STAINLESS STEEL**



**BEARING STEEL AISI 440C**



The bearings shown on this page have normal radial clearance according to ISO 5753-2009 and precision class according to ISO 492-2014 . For details and other radial clearances click the "Related Information" button.

Part number	Principal dimensions			Load ratings		Speed limits	Weight	Radius			
	Bore	Outer	Width	Dynamic	Static	Grease					
	d	D	B	C	C0	rpm	Kg	rs min mm			
mm									kN		1 min <sup>-1</sup>
S6805 2RS	25	37	7	4,30	2,95	18000	0,0220	0,30			
S6905 2RS	25	42	9	7,05	4,55	16000	0,0420	0,30			
S6005 2RS	25	47	12	10,10	5,85	15000	0,0800	0,60			
S6205 2RS	25	52	15	14,00	7,85	13000	0,1280	1,00			
S6305 2RS	25	62	17	21,20	10,90	12000	0,2320	1,10			
S6806 2RS	30	42	7	4,70	3,65	15000	0,0260	0,30			
S6906 2RS	30	47	9	7,25	5,00	14000	0,0480	0,30			
S6006 2RS	30	55	13	13,20	8,30	13000	0,1160	1,00			
S6206 2RS	30	62	16	19,50	11,30	11000	1,1990	1,00			
S6306 2RS	30	72	19	26,70	15,00	10000	0,3500	1,10			
S6807 2RS	35	47	7	4,90	4,05	13000	0,0290	0,30			
S6907 2RS	35	55	10	11,20	7,45	12000	0,0740	0,60			
S6007 2RS	35	62	14	16,00	10,30	12000	0,1550	1,00			
S6207 2RS	35	72	17	25,70	15,30	9800	0,2880	1,10			
S6307 2RS	35	80	21	33,50	19,10	8800	0,4570	1,50			
S6808 2RS	40	52	7	5,10	4,40	12000	0,0330	0,30			
S6908 2RS	40	62	12	14,60	10,20	11000	0,1100	0,60			
S6008 2RS	40	68	15	16,80	11,50	10000	0,1900	1,00			
S6208 2RS	40	80	18	29,10	17,80	8700	3,3660	1,10			
S6308 2RS	40	90	23	40,50	24,00	7800	0,6300	1,50			
S6809 2RS	45	58	7	6,40	5,65	11000	0,0400	0,30			
S6909 2RS	45	68	12	15,10	11,20	9800	0,1280	0,60			
S6009 2RS	45	75	16	21,00	15,10	9200	0,2370	1,00			
S6209 2RS	45	85	19	32,50	20,40	7800	0,3980	1,10			
S6309 2RS	45	100	25	53,00	32,00	7000	0,8140	1,50			
S6810 2RS	50	65	7	6,60	6,10	9600	0,0520	0,30			
S6910 2RS	50	72	12	15,60	12,20	8900	0,1320	0,60			
S6010 2RS	50	80	16	21,80	16,60	8400	0,2610	1,00			
S6210 2RS	50	90	20	35,00	23,20	7100	0,4540	1,10			
S6310 2RS	50	110	27	62,00	38,50	6400	1,0700	2,00			
S6811 2RS	55	72	9	8,80	8,10	8700	0,0830	0,30			
S6911 2RS	55	80	13	16,00	13,30	8200	0,1800	1,00			
S6011 2RS	55	90	18	28,30	21,20	7700	0,3880	1,10			
S6211 2RS	55	100	21	43,50	29,20	6400	0,6010	1,50			
S6311 2RS	55	120	29	71,50	45,00	5800	1,3700	2,00			
S6812 2RS	60	78	10	11,50	10,60	8000	0,1060	0,30			
S6912 2RS	60	85	13	16,40	14,30	7600	0,1930	1,00			
S6012 2RS	60	95	18	31,60	24,20	7000	0,4140	1,10			
S6212 2RS	60	110	22	52,50	36,00	6000	0,7830	1,50			
S6913 2RS	65	90	13	17,40	16,10	7000	0,2060	1,00			
S6813 2RS	65	95	10	11,60	11,00	7400	0,1280	0,60			
S6013 2RS	65	100	18	30,50	25,20	6500	0,4210	1,10			
S6213 2RS	65	120	23	57,50	40,00	5500	0,9900	1,50			
S6814 2RS	70	90	10	12,10	11,90	6900	0,1370	0,60			
S6914 2RS	70	100	16	23,70	21,20	6500	0,3340	1,00			
S6014 2RS	70	110	20	38,00	31,00	6100	0,6040	1,10			
S6815 2RS	75	95	10	12,50	12,90	6400	0,1450	0,60			
S6915 2RS	75	105	16	24,40	22,60	6100	0,3530	1,00			
S6816 2RS	80	100	10	12,70	13,30	6000	0,1540	0,60			
S6916 2RS	80	110	16	24,90	24,00	5700	0,3730	1,00			



Deep Groove Ball Bearing	<b>Self-Aligning Ball Bearing</b>	Angular Contact Ball Bearing	
Cylindrical Roller Bearing	Tapered Roller Bearing	Spherical Roller Bearing	
Thrust Ball Bearing	Spherical Roller Thrust Bearing	Accessories Adapter & Withdrawal Sleeve	Technical & Related Information

# 25010a

## Self Aligning Ball Bearing

### Introduction



Click here for  
Technical & Related  
Information

Self Aligning Ball Bearings have two rows of balls, located on the inner ring and a spherical outer track. This design permits misalignment of the inner and outer races caused, for example, by shaft deflection or variation in housing alignment. These bearings are also manufactured with tapered bore for use with adapter sleeves. Sealed version available.

Dimensions in accordance with ISO 15:2011

Misalignment

Maximum permitted misalignment in degrees.

Bearing series	Maximum inclination in degrees
108, 126, 127, 129, 135	3°
Series 12	2.5°
Series 13	3°
Series 22	2.5°
Series 22-2RS	1.5°
Series 23	3°
Series 23-2RS	1.5°



Self Aligning Ball Bearing with cylindrical and tapered bore

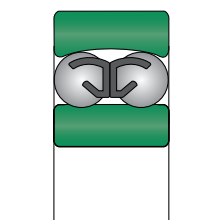

**cylindrical bore**

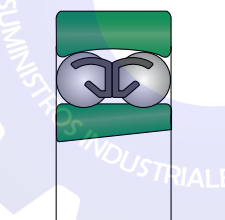

**tapered bore (suffix K)**

Self Aligning Ball Bearing with adapter sleeve tapered bore

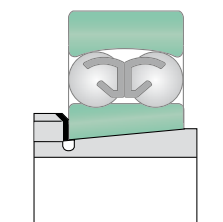

**adapter sleeve, lock nut and lock washer**



Deep Groove Ball Bearing	<b>Self-Aligning Ball Bearing</b>	Angular Contact Ball Bearing	
Cylindrical Roller Bearing	Tapered Roller Bearing	Spherical Roller Bearing	
Thrust Ball Bearing	Spherical Roller Thrust Bearing	Accessories Adapter & Withdrawal Sleeve	Technical & Related Information



# 2 5 1 0 0 a

## Self Aligning Ball Bearing

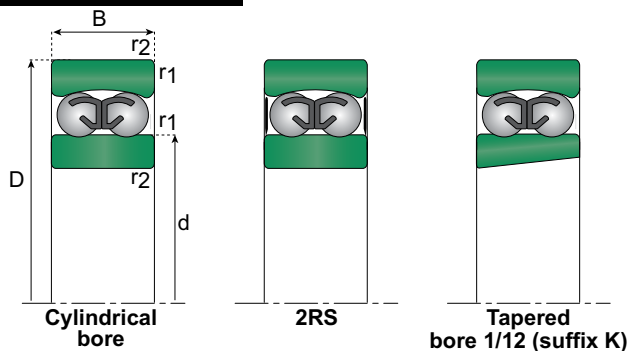

Click here for Technical & Related Information

[Index other bore sizes](#)

**BEARING STEEL 100Cr6**



The bearings shown on this page have normal radial clearance according to ISO 5753-2009 and precision class according to ISO 492-2014.

For details and other radial clearances click the "Technical & Related Information" button.

Part number	Principal dimensions			Load ratings		Speed limits		Weight	Dimensions	Calculation factors			
	Bore	Outer	Width	Dynamic	Static	Grease	Oil			r1/r2	e	Y1	Y2
	d	D	B	C	Co	rpm		Kg	mm				
	mm			kN		1 min <sup>-1</sup>							
135	5	19	6	2,55	0,48	30000	36000	0,01	0,3	0,33	1,9	3	2
126	6	19	6	2,5	0,48	30000	36000	0,01	0,3	0,33	1,9	3	2
127	7	22	7	2,65	0,56	30000	36000	0,01	0,3	0,33	1,9	3	2
108	8	22	7	2,65	0,56	30000	36000	0,01	0,3	0,33	1,9	3	2
129	9	26	8	3,8	0,8	26000	32000	0,02	0,6	0,33	1,9	3	2
1200	10	30	9	5,5	1,2	24000	30000	0,03	0,6	0,33	1,9	3	2
1300	10	35	11	7,2	1,6	20000	26000	0,02	0,6	0,34	1,9	2,9	1,9
2200	10	30	14	7,2	1,6	22000	28000	0,04	0,6	0,54	1,2	1,8	1,2
1201	12	32	10	5,6	1,25	22000	28000	0,04	0,6	0,37	1,7	2,6	1,8
1301	12	37	12	9,4	2,15	18000	22000	0,06	1	0,35	1,8	2,8	1,9
2201	12	32	14	7,6	1,75	20000	26000	0,05	0,6	0,53	1,2	1,8	1,2
2301	12	37	17	9,4	2,3	17000	20000	0,09	1	0,54	1,2	1,8	1,2
1202	15	35	11	7,5	1,75	19000	24000	0,04	0,6	0,36	1,8	2,7	1,9
1302	15	42	13	9,55	2,3	17000	20000	0,09	1	0,35	1,8	2,8	1,9
2202	15	35	14	7,7	1,85	18000	22000	0,06	0,6	0,5	1,3	2	1,3
2302	15	42	17	12,1	2,9	15000	18000	0,11	1	0,5	1,3	2	1,3
1203	17	40	12	7,9	2,05	18000	22000	0,07	0,6	0,32	1,9	3	2
1303	17	47	14	12,5	3,15	14000	17000	0,13	1	0,34	1,8	2,9	2
2203	17	40	16	9,8	2,4	17000	20000	0,08	0,6	0,5	1,3	2	1,3
2303	17	47	19	14,5	3,6	13000	16000	0,16	1	0,49	1,3	2	1,3
1204	20	47	14	9,9	2,65	15000	18000	0,120	1,0	0,28	2,2	3,5	2,4
1304	20	52	15	12,4	3,35	12000	15000	0,160	1,1	0,30	2,1	3,3	2,2
2204	20	47	18	12,6	3,30	14000	17000	0,140	1,0	0,28	2,2	3,5	2,4
2304	20	52	21	18,2	4,70	11000	14000	0,210	1,1	0,52	1,2	1,9	1,3
1205	25	52	15	12,2	3,30	13000	16000	0,140	1,0	0,29	2,2	3,4	2,3
1305	25	62	17	17,8	4,90	9500	12000	0,260	1,1	0,28	2,2	3,5	2,4
2205 2RS	25	52	18	12,2	3,30	7000		0,160	1,0	0,29	2,2	3,4	2,3
2205	25	52	18	12,5	3,45	11000	14000	0,160	1,0	0,43	1,5	2,3	1,6
2305 2RS	25	62	24	17,8	4,90	6300		0,330	1,1	0,28	2,2	3,5	2,4
2305	25	62	24	24,5	6,55	9500	12000	0,340	1,1	0,44	1,4	2,2	1,5
1206	30	62	16	15,7	4,70	10000	13000	0,220	1,0	0,25	2,5	3,9	2,7
1306	30	72	19	21,4	6,35	9000	11000	0,380	1,1	0,24	2,6	4,1	2,8
2206 2RS	30	62	20	15,7	4,70	5300		0,260	1,0	0,25	2,5	3,9	2,7
2206	30	62	20	15,3	4,60	9500	12000	0,260	1,0	0,40	1,6	2,5	1,7
2306 2RS	30	72	27	21,4	6,35	5600		0,500	1,1	0,24	2,6	4,1	2,8
2306	30	72	27	31,4	8,70	8500	10000	0,500	1,1	0,40	1,6	2,5	1,7
1207	35	72	17	15,8	5,15	9000	11000	0,320	1,1	0,23	2,8	4,2	2,9
1307	35	80	21	25,1	7,95	7500	9000	0,510	1,5	0,25	2,5	3,9	2,7
2207 2RS	35	72	23	15,8	5,15	5600		0,400	1,1	0,23	2,8	4,2	2,9
2207	35	72	23	21,7	6,70	8500	10000	0,400	1,1	0,37	1,7	2,6	1,8
2307 2RS	35	80	31	25,1	7,95	4500		0,670	1,5	0,25	2,5	3,9	2,7
2307	35	80	31	39,7	12,90	7000	8500	0,670	1,5	0,43	1,5	2,3	1,6
1208	40	80	18	19,2	6,50	8500	10000	0,410	1,1	0,22	2,9	4,5	3,0
1308	40	90	23	29,5	9,75	6700	8000	0,710	1,5	0,24	2,6	4,1	2,8
2208 2RS	40	80	23	19,2	6,50	4800		0,500	1,1	0,22	2,9	4,5	3,0
2208	40	80	23	22,4	7,40	7500	9000	0,500	1,1	0,33	1,9	3,0	2,0
2308 2RS	40	90	33	29,5	9,75	4000		0,920	1,5	0,24	2,6	4,1	2,8
2308	40	90	33	44,9	15,10	6300	7500	0,920	1,5	0,39	1,6	2,5	1,7



Deep Groove Ball Bearing	<b>Self-Aligning Ball Bearing</b>	Angular Contact Ball Bearing	
Cylindrical Roller Bearing	Tapered Roller Bearing	Spherical Roller Bearing	
Thrust Ball Bearing	Spherical Roller Thrust Bearing	Accessories Adapter & Withdrawal Sleeve	Technical & Related Information



# 2 5 1 0 0 b

## Self Aligning Ball Bearing

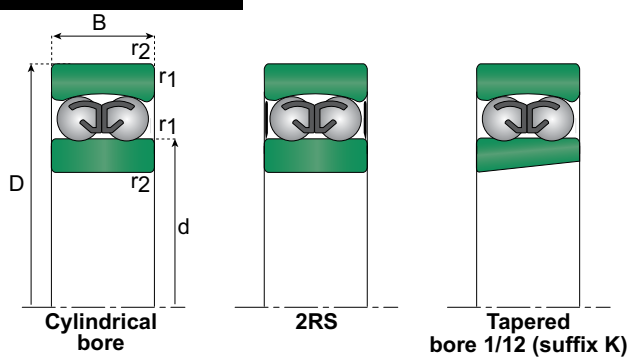

Click here for Technical & Related Information

[Index other bore sizes](#)

**BEARING STEEL 100Cr6**



The bearings shown on this page have normal radial clearance according to ISO 5753-2009 and precision class according to ISO 492-2014.

For details and other radial clearances click the "Technical & Related Information" button.

Part number	Principal dimensions			Load ratings		Speed limits		Weight	Dimensions	Calculation factors				
	Bore	Outer	Width	Dynamic	Static	Grease	Oil			r1/r2	e	Y1	Y2	Y0
	d	D	B	C	Co	rpm	1 min <sup>-1</sup>							
1209	45	85	19	21,8	7,40	7500	9000	0,460	1,1	0,21	3,0	4,7	3,2	
1309	45	100	25	37,7	12,90	6300	7500	0,950	1,5	0,24	2,6	4,1	2,8	
2209 2RS	45	85	23	21,8	7,40	4500		0,540	1,1	0,21	3,0	4,7	3,2	
2209	45	85	23	23,3	8,15	7000	8500	0,540	1,1	0,31	2,0	3,1	2,1	
2309 2RS	45	100	36	37,7	12,90	3600		1,230	1,5	0,24	2,6	4,1	2,8	
2309	45	100	36	54,1	16,50	5600	6700	1,230	1,5	0,31	2,0	3,1	2,1	
1210	50	90	20	22,9	8,10	7000	8500	0,520	1,1	0,21	3,0	4,7	3,2	
1310	50	110	27	43,4	14,20	5600	6700	1,210	2,0	0,24	2,6	4,1	2,8	
2210 2RS	50	90	23	22,9	8,10	4000		0,590	1,1	0,21	3,0	4,6	3,2	
2210	50	90	23	23,3	8,50	6300	7500	0,590	1,1	0,29	2,2	3,4	2,3	
2310 2RS	50	110	40	43,4	14,20	3400		1,640	2,0	0,24	2,6	4,1	2,8	
2310	50	110	40	64,4	20,00	5300	6300	1,230	2,0	0,42	1,5	2,3	1,6	
1211	55	100	21	26,6	10,10	6300	7500	0,700	1,5	0,20	3,2	4,9	3,3	
1311	55	120	29	51,3	18,10	5000	6000	1,580	2,0	0,23	2,3	4,2	2,9	
2211	55	100	25	26,5	9,90	6000	7000	0,810	1,5	0,27	2,3	3,6	2,5	
2311	55	120	43	75,3	23,80	4800	5600	2,100	2,0	0,41	1,5	2,4	1,6	
1212	60	110	22	30,2	11,60	5600	6700	0,900	1,5	0,19	3,4	5,2	3,5	
1312	60	130	31	57,1	20,80	4500	5300	1,960	2,1	0,23	2,8	4,2	2,9	
2212	60	110	28	33,8	12,60	5300	6300	1,100	1,5	0,28	2,2	3,5	2,4	
2312	60	130	46	87,1	28,00	4300	5000	2,600	2,1	0,41	1,5	2,4	1,6	
1213	65	120	23	31,0	12,40	5300	6300	1,150	1,5	0,17	3,7	5,7	3,9	
1313	65	140	33	62,0	22,90	4300	5000	2,450	2,1	0,23	2,8	4,2	2,8	
2213	65	120	31	43,6	16,40	5000	6000	1,450	1,5	0,28	2,2	3,5	2,4	
2313	65	140	48	95,6	32,50	4000	4800	3,250	2,1	0,38	1,7	2,6	1,7	
1214	70	125	24	34,6	13,70	5000	6000	1,250	1,5	0,18	3,5	5,4	3,7	
1314	70	150	35	74,1	27,70	4000	4800	3,000	2,1	0,22	2,9	4,5	3,0	
2214	70	125	31	44,2	17,10	4800	5600	1,500	1,5	0,27	2,3	3,6	2,5	
2314	70	150	51	111,0	31,70	3600	4300	3,900	2,1	0,35	1,8	2,8	1,9	
1215	75	130	25	38,9	15,60	4800	5600	1,350	1,5	0,18	3,5	5,4	3,7	
1315	75	160	37	79,2	30,00	3600	4300	3,550	2,1	0,22	2,9	4,5	3,0	
2215	75	130	31	44,0	17,80	4500	5300	1,600	1,5	0,25	2,5	3,9	2,7	
2315	75	160	55	123,0	42,80	3400	4000	4,700	2,1	0,38	1,7	2,6	1,7	
1216	80	140	26	39,8	17,00	4300	5000	1,650	2,0	0,16	3,9	6,1	4,1	
1316	80	170	39	88,4	33,00	3400	4000	4,200	2,1	0,22	2,9	4,5	3,0	
2216	80	140	33	48,8	19,90	4000	4800	2,000	2,0	0,26	2,4	3,7	2,5	
2316	80	170	58	136,0	48,50	3200	3800	6,100	2,1	0,34	1,9	2,9	2,0	
1217	85	150	28	48,2	20,80	4000	4800	2,050	2,0	0,17	3,7	5,7	3,9	
1317	85	180	41	97,5	37,90	3200	4800	5,000	3,0	0,22	2,9	4,5	3,0	
2217	85	150	36	58,5	23,80	3800	4800	2,500	2,0	0,25	2,5	3,9	2,7	
2317	85	180	60	140,0	51,50	3000	3600	7,050	3,0	0,37	1,7	2,6	1,8	
1218	90	160	30	57,0	23,10	3800	4500	2,500	2,0	0,17	3,7	5,7	3,9	
1318	90	190	43	117,0	44,50	3000	3600	5,800	3,0	0,22	2,9	4,5	3,0	
2218	90	160	40	70,2	27,20	3600	4300	3,400	2,0	0,27	2,3	3,6	2,5	
2318	90	190	64	153,0	57,70	2800	3400	8,450	3,0	0,38	1,7	2,6	1,7	
1219	95	170	32	63,7	24,30	3400	4000	3,100	2,1	0,17	3,7	5,7	3,9	
1319	95	200	45	133,0	50,80	2800	3400	6,700	3,0	0,23	2,8	4,2	2,9	
1220	100	180	34	68,9	29,70	3200	3800	3,700	2,1	0,17	3,7	5,7	3,9	
1320	100	215	47	143,0	57,30	2600	3200	8,300	3,0	0,24	2,6	4,1	2,8	
2220	100	180	46	97,5	34,00	3200	3800	5,000	2,1	0,24	2,6	4,1	2,8	
2320	100	215	73	193,0	73,40	2400	3000	12,200	3,0	0,34	1,9	2,9	2,0	
1222	110	200	38	88,0	35,20	2800	3400	5,150	2,1	0,17	3,7	5,7	3,9	
1322	110	240	50	163,0	67,50	2400	3000	12,000	3,0	0,22	2,9	4,5	3,0	
2222	110	200	53	124,0	48,90	2800	3400	7,100	2,1	0,26	2,4	3,7	2,5	



Deep Groove Ball Bearing	Self-Aligning Ball Bearing	<b>Angular Contact Ball Bearing</b>	
Cylindrical Roller Bearing	Tapered Roller Bearing	Spherical Roller Bearing	
Thrust Ball Bearing	Spherical Roller Thrust Bearing	Accessories Adapter & Withdrawal Sleeve	Technical & Related Information



# 30010a

## Angular Contact Ball Bearing

### Introduction

Single row angular contact ball bearings are designed especially to carry combination radial and single direction thrust loads. To carry thrust loads from opposing directions, these bearings are frequently mounted in duplex pairs with the contact angles opposed.

Angular Contact Bearing can be mounted in a variety of ways, for example "back to back" and "face to face," as illustrated below.

Bearings are also available with universal flush ground side surfaces of the inner and outer rings for duplex mountings. Flush ground bearings are available in different preloads to give axial rigidity. Angular Contact Bearing are offered in extra light, light, and medium series. Each series is available in 15, 25, and 40 contact angles to fulfill a wide variety of applications. A higher contact angle increases thrust capacity and axial rigidity, but reduces radial capacity and radial rigidity. Pressed steel, machined bronze, and phenolic cages are available to meet a variety of speed and duty requirements.



Click here for  
Technical & Related  
Information

Dimensions in accordance with ISO 355:2007

Single row angular contact ball bearings

**Series 72 B, 73 B**

**Contact angle**

$\alpha = 40^\circ$



**Series 70 A, 72 A**

**Contact angle**

$\alpha = 25^\circ$

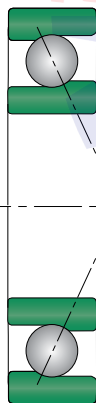

**Series 70 C, 72 C**

**Contact angle**

$\alpha = 15^\circ$



**DB arrangement  
(back to back)**

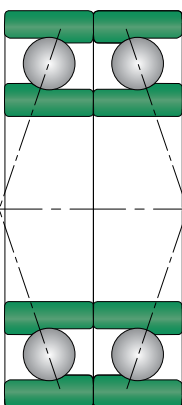

**DF arrangement  
(face to face)**

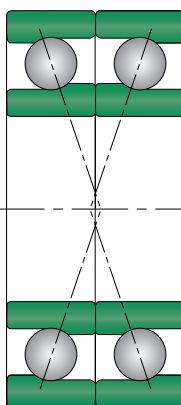

**DT arrangement  
(tandem)**

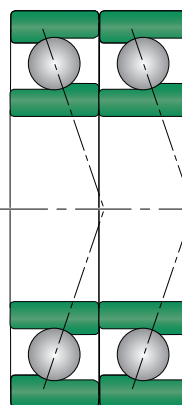



Deep Groove Ball Bearing	Self-Aligning Ball Bearing	<b>Angular Contact Ball Bearing</b>	
Cylindrical Roller Bearing	Tapered Roller Bearing	Spherical Roller Bearing	
Thrust Ball Bearing	Spherical Roller Thrust Bearing	Accessories Adapter & Withdrawal Sleeve	Technical & Related Information



Click here for Technical & Related Information

### 30100a

## Single Row Angular Contact Ball Bearing

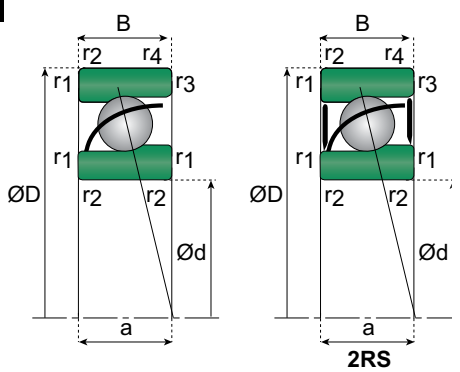

Part number	Principal dimensions			Load ratings		Speed limits		Weight Kg	Dimensions		
	Bore	Outer	Width	Dynamic	Static	Grease	Oil		r1/r2	r3/r4	a
	d	D	B	C	Co	rpm			mm		
	mm			kN		1 min <sup>-1</sup>					
7200 B	10	30	9	4,95	2,5	19000	28000	0,031	0,6	0,3	13
7201 B	12	32	10	7,4	3,75	17000	24000	0,045	0,6	0,3	14
7202 B	15	35	11	7,45	3,9	16000	22000	0,048	0,6	0,3	16
7302 B	15	42	13	12,90	6,5	14000	19000	0,090	1,0	0,6	19
7203 B	17	40	12	9,9	5,5	14000	19000	0,065	0,6	0,3	18
7203 B TN	17	40	12	9,9	5,5	14000	19000	0,065	0,6	0,3	18
7303 B	17	47	14	14,8	8,1	12000	17000	0,120	1,0	0,6	21
7204 B	20	47	14	14,1	8,4	11000	16000	0,110	1,0	0,6	21
7304 B	20	52	15	17,3	9,7	10000	15000	0,150	1,1	0,6	23
7005 B	25	47	12	13,9	8,5	11000	16000	0,120	0,6	0,3	8
7005 B 2RSR	25	47	12	10,8	7,0	7750		0,120	0,6	0,3	8
7205 B	25	52	15	15,5	10,1	9500	14000	0,130	1,0	0,6	24
7305 B	25	62	17	24,4	14,6	8500	12000	0,250	1,1	0,6	27
7206 B	30	62	16	20,5	13,6	8500	12000	0,210	1,0	0,6	27
7306 B	30	72	19	29,3	19,0	7500	10000	0,370	1,1	0,6	31
7207 B	35	72	17	28,5	19,8	7500	10000	0,300	1,1	0,6	31
7307 B	35	80	21	36,7	24,3	7000	9500	0,510	1,5	1,0	35
7208 B	40	80	18	32,1	23,0	6700	9000	0,390	1,1	0,6	34
7308 B	40	90	23	44,8	30,3	6300	8500	0,670	1,5	1,0	39
7209 B	45	85	19	36,1	26,2	6300	8500	0,440	1,1	0,6	37
7309 B	45	100	25	58,3	40,1	5600	7500	0,900	1,5	1,0	43
7210 B	50	90	20	37,4	28,6	5600	7500	0,490	1,1	0,6	39
7310 B	50	110	27	68,2	47,9	5000	6700	1,150	2,0	1,0	47
7211 B	55	100	21	46,2	36,2	5300	7000	0,650	1,5	1,0	43
7311 B	55	120	29	78,8	56,4	4500	6000	1,450	2,0	1,0	51
7212 B	60	110	22	56,3	44,7	4800	6300	0,840	1,5	1,0	47
7312 B	60	130	31	90,0	65,5	4300	5600	1,850	2,1	1,1	56
7213 B	65	120	23	63,6	52,5	4300	5600	1,050	1,5	1,0	50
7313 B	65	140	33	101,0	75,3	4000	5300	2,250	2,1	1,1	60
7214 B	70	125	24	69,1	57,8	4300	5600	1,150	1,5	1,0	53
7314 B	70	150	35	114,0	86,0	3800	5000	2,750	2,1	1,1	64
7215 B	75	130	25	74,8	63,2	4000	5300	1,300	1,5	1,0	56
7315 B	75	160	37	125,0	97,5	3400	4500	3,300	2,1	1,1	68
7216 B	80	140	26	80,5	69,3	3800	5000	1,550	2,0	1,0	59
7316 B	80	170	39	135,0	109,0	3200	4300	3,900	2,1	1,1	72
7217 B	85	150	28	93,1	81,1	3400	4500	1,950	2,0	1,0	64
7317 B	85	180	41	145,0	122,0	3000	4000	4,600	3,0	1,1	76
7218 B	90	160	30	107,0	93,8	3200	4300	2,400	2,0	1,0	67
7318 B	90	190	43	156,0	135,0	2800	3800	5,400	3,0	1,1	80
7219 B	95	170	32	116,0	101,0	3000	4000	2,900	2,1	1,1	71
7319 B	95	200	45	168,0	150,0	2600	3600	6,250	3,0	1,1	84
7220 B	100	180	34	129,0	116,0	2800	3800	3,450	2,1	1,1	76
7320 B	100	215	47	190,0	178,0	2400	3400	7,750	3,0	1,1	90
7222 B	110	200	38	153,0	145,0	2400	3400	4,800	2,1	1,1	84
7322 B	110	240	50	248,0	229,0	2000	3000	10,500	3,0	1,1	99
7328 B	140	300	62	290,0	334,0	1700	2400	21,600	4,0	1,5	123

Index other bore sizes

BEARING STEEL 100Cr6

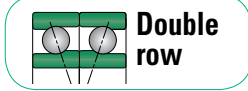

Details part number:

- Suffix **A**: inclination 25° contact angle
- Suffix **B**: inclination 40° contact angle
- Suffix **C**: inclination 15° contact angle





Deep Groove Ball Bearing	Self-Aligning Ball Bearing	<b>Angular Contact Ball Bearing</b>	
Cylindrical Roller Bearing	Tapered Roller Bearing	Spherical Roller Bearing	
Thrust Ball Bearing	Spherical Roller Thrust Bearing	Accessories Adapter & Withdrawal Sleeve	Technical & Related Information



Click here for Technical & Related Information

### 30100b

## Double Row Angular Contact Ball Bearing

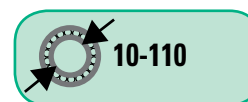
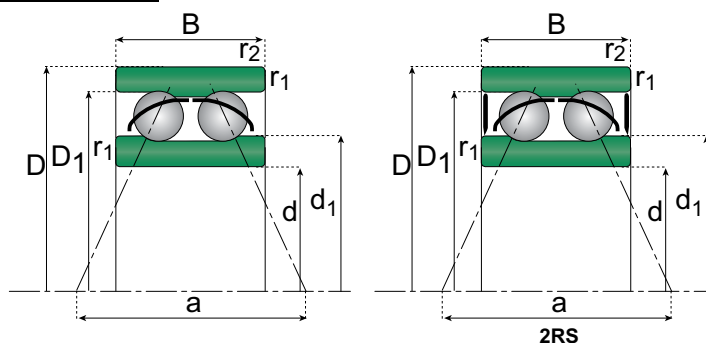

Part number	Principal dimensions			Load ratings		Speed limits		Weight Kg	Dimensions	
	Bore	Outer	Width	Dynamic	Static	Grease	Oil		r1/r2	a
	d	D	B	C	Co	rpm			mm	
	mm			kN		1 min <sup>-1</sup>				
3200	10	30	14,3	7,8	3,9	16000	22000	0,05	0,6	19
3201	12	32	15,9	10,6	5,1	15000	20000	0,06	0,6	22
3202	15	35	15,9	11,8	6,1	13000	18000	0,07	0,6	23
3302	15	42	19	16,3	8,7	10000	15000	0,13	1	27
3203 2RS	17	40	17,5	14,6	7,8	7500	-	0,1	0,6	27
3203	17	40	17,5	14,6	7,8	10000	15000	0,1	0,6	27
3303	17	47	22,2	20,8	10,6	9500	14000	0,19	1	31
3204	20	47	20,6	19,6	10,8	9000	13000	0,170	1,0	31
3304	20	52	22,2	23,2	12,9	8500	12000	0,230	1,1	34
3205	25	52	20,6	21,2	12,7	8000	11000	0,190	1,0	35
3305	25	62	25,4	29,2	17,3	7500	10000	0,370	1,1	40
3206	30	62	23,8	28,1	18,3	7000	9500	0,310	1,0	41
3306	30	72	30,2	38,0	24,5	6300	8500	0,580	1,1	47
3207	35	72	27,0	39,0	25,0	6000	8000	0,480	1,1	47
3307	35	80	34,9	51,0	30,0	5600	7500	0,780	1,5	54
3208	40	80	30,2	48,0	31,5	5600	7500	0,650	1,1	52
3308	40	90	36,5	62,0	39,0	5000	6700	1,050	1,5	58
3308 2RS	40	90	36,5	60,5	44,0	4200	-	1,750	1,5	58
3209	45	85	30,2	49,0	32,5	5000	6700	0,700	1,1	56
3309	45	100	39,7	71,0	57,0	4500	6000	1,410	1,5	64
3210	50	90	30,2	51,0	36,0	4800	6300	0,740	1,1	59
3310	50	110	44,4	85,0	75,0	4000	5300	1,900	2,0	73
3211	55	100	33,3	54,0	55,0	4300	5600	1,050	1,5	64
3311	55	120	49,2	98,0	88,0	3600	4800	2,480	2,0	80
3212	60	110	36,5	69,5	72,0	3800	5000	1,360	1,5	71
3312	60	130	54,0	114,0	112,0	3400	4500	3,170	2,1	86
3213	65	120	38,1	73,5	83,0	3600	4800	1,760	1,5	76
3313	65	140	58,7	129,0	130,0	3200	4300	4,010	2,1	94
3214	70	125	39,7	81,5	91,5	3200	4300	1,930	1,5	81
3314	70	150	63,5	143,0	146,0	2800	3800	5,040	2,1	101
3215	75	130	41,3	85,0	98,0	3200	4300	2,080	1,5	84
3315	75	160	68,3	163,0	166,0	2600	3600	6,160	2,1	107
3216	80	140	44,4	95,0	110,0	2800	3800	2,640	2,0	91
3316	80	170	68,3	176,0	186,0	2400	3400	6,930	2,1	112
3217	85	150	49,2	112,0	132,0	2600	3600	3,390	2,0	97
3317	85	180	73,0	190,0	200,0	2200	3200	8,300	3,0	119
3218	90	160	52,4	125,0	146,0	2400	3400	4,140	2,0	104
3318	90	190	73,0	216,0	240,0	2000	3000	9,230	3,0	125
3219	95	170	55,6	140,0	163,0	2200	3200	5,000	2,1	111
3319	95	200	77,8	220,0	245,0	1900	2800	11,400	3,0	133
3220	100	180	60,3	160,0	196,0	2000	3000	6,100	2,1	118
3320	100	215	82,6	240,0	280,0	1800	2600	14,200	3,0	139
3222	110	200	69,8	190,0	228,0	1900	2800	8,790	2,1	132
3322	110	240	92,1	280,0	400,0	1800	2600	19,000	3,0	153

Index other bore sizes

BEARING STEEL 100Cr6

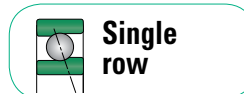

Details part number:

- Suffix **A**: inclination 25° contact angle
- Suffix **B**: inclination 40° contact angle
- Suffix **C**: inclination 15° contact angle



Deep Groove Ball Bearing	Self-Aligning Ball Bearing	Angular Contact Ball Bearing	
<b>Cylindrical Roller Bearing</b>	Tapered Roller Bearing	Spherical Roller Bearing	
Thrust Ball Bearing	Spherical Roller Thrust Bearing	Accessories Adapter & Withdrawal Sleeve	Technical & Related Information



# 3 5 0 1 0 a

## Cylindrical Roller Bearing

### Introduction



Click here for  
Technical & Related  
Information

Cylindrical roller bearings are manufactured in a number of designs as indicated below. The predominant type being the single row roller. The roller and cage assembly are guided axially by the integral flanges (ribs) on one of the bearing rings. This design facilitates ease of mounting and dismounting, particularly where both races are an interference fit on their seatings. Roller bearings with flanges (ribs) on one race only do not provide any end location. Various roller bearings with ribs on both races provide axial location, and are capable of carrying light or intermittent axial loading. These patterns are of the NJ, NUP and NJ+HJ types. If used for axial location and light axial loads, the contact between the flanges (ribs) and the roller ends is that of a sliding bearing, not rolling bearing; therefore lubrication is of paramount importance.

Alignment is much more critical than that of a ball bearing; as a general guide, this is limited to approximately .003 radians. Double and multi-row bearings are also manufactured - see NN and NNU series.



Dimensions in accordance with ISO 15-2011

### Single Row Cylindrical Roller Bearing

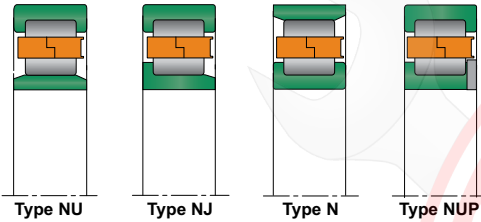

Of these bearings, the NJ, NUP and NJH types can also carry light or intermittent thrust loads between the guide rib and the end of the rollers. Several arrangements of locating ribs are available, as illustrated. The choice between these types is usually decided by consideration of assembly procedure or machine clearances. The bearings utilizing machined bronze cages are suitable for high speed operation. The NN 30 and NN 30 K series are available in high precision tolerances and, due to their extreme rigidity, are particularly suited for use in machine tool spindles.

### Double Row Cylindrical Roller Bearing

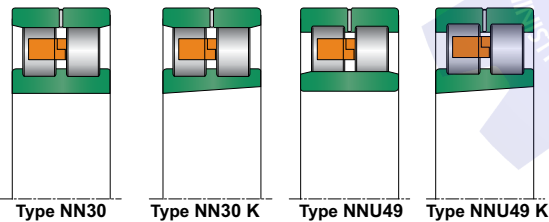

Typical suffixes used for cylindrical roller bearings:

- E - Increased loading capacity
- NA - Non-interchangeable components
- M - Brass cage guided on the rollers
- EM - Increased loading capacity and brass cage guided on the rollers
- EMA - Increased loading capacity and brass cage guided on the outer ring

### Single Row Full Cylindrical Roller Bearing

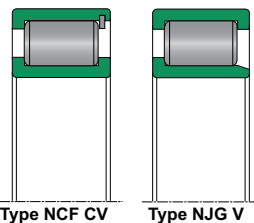

### Single Row Full Cylindrical Roller Bearing

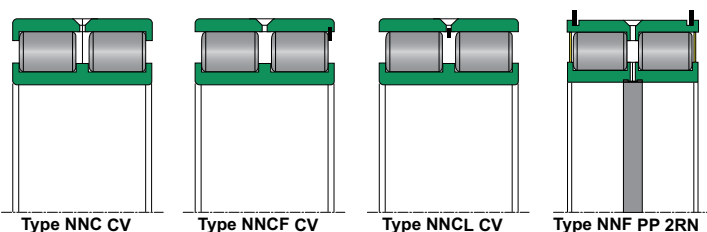

### Angular Misalignment

the following is an approximate guide to the misalignment that can be accommodated in a cylindrical roller bearing:  
0.0004 radians  
Greater misalignment under heavy radial load can be critical.







Deep Groove Ball Bearing	Self-Aligning Ball Bearing	Angular Contact Ball Bearing	
<b>Cylindrical Roller Bearing</b>	Tapered Roller Bearing	Spherical Roller Bearing	
Thrust Ball Bearing	Spherical Roller Thrust Bearing	Accessories Adapter & Withdrawal Sleeve	Technical & Related Information



### 3 5 1 0 0 a

## Single Row Cylindrical Roller Bearing

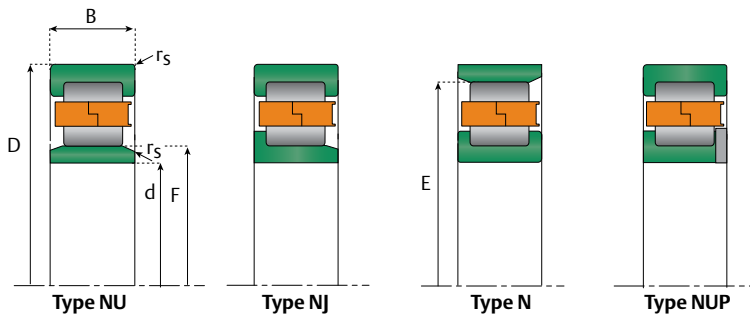

Click here for  
Technical & Related  
Information

Part number	Principal dimensions			Basic load ratings		Speed limits		Weight Kg	Radius		Dimensions	
	Bore	Outer	Width	Dynamic	Static	Grease	Oil		rS min	r1s min	F	E
	d	D	B	C	Co	rpm			mm		mm	
NU 202 E	15	35	11	13,5	11,2	18000	22000	0,052	0,6	0,3	19,3	
NJ 203	17	40	12	11,2	9	17000	20000	0,091	0,6	0,3	22,1	
NU 203 M	17	40	12	14,5	12,8	18000	20000	0,08	0,6	0,3	22,1	
NU 203 EM	17	40	12	17,6	14,6	18000	18000	0,01	0,6	0,3	22,1	
NU 2203 E	17	40	16	22,4	19,8	16000	19000	0,097	0,6	0,3	22,1	
NJ 2203 E	17	40	16	22,1	19,8	16000	19000	0,097	0,6	0,3	22,1	
NUP 2203 E	17	40	16	22,4	19,8	16000	19000	0,089	0,6	0,3	22,1	
NU 303	17	47	14	16,4	13	13000	16000	0,12	1	0,6	25,1	
N 204	20	47	14	15,2	12,5	15000	18000	0,11	1	0,6		40,0
NJ 204 E	20	47	14	25,7	22,6	15000	18000	0,11	1	0,6	26,5	
NJ 204 EM	20	47	14	25,7	22,6	15000	18000	0,11	1	0,6	26,5	
NU 204 E	20	47	14	25,7	22,6	15000	18000	0,11	1	0,6	26,5	
NU 204 EM	20	47	14	25,7	22,6	17000	20000	0,12	1	0,6	27,0	
NUP 204 EM	20	47	14	25,7	22,6	15000	18000	0,11	1	0,6	26,5	
NUP 204 E	20	47	14	25,7	22,6	15000	18000	0,11	1	0,6	26,5	
NJ 2204 E	20	47	18	30,6	28,3	13000	16000	0,142	1	0,6	26,5	
NJ 2204 EM	20	47	18	30,6	28,3	13000	16000	0,142	1	0,6	26,5	
NU 2204 E	20	47	18	30,6	28,3	13000	16000	0,14	1	0,6	27,0	
NU 2204 EM	20	47	18	30,5	28,2	13000	16000	0,137	1	0,6	26,5	
NUP 2204 E	20	47	18	30,6	28,3	13000	16000	0,14	1	0,6	28,5	
NJ 304 EM	20	52	15	31,7	26,9	12000	15000	0,14	1,1	0,6	28,5	
NU 304 EM	20	52	15	31,7	26,9	12000	15000	0,14	1,1	0,6	28,5	
NUP 304 EM	20	52	15	31,7	26,9	12000	15000	0,22	1,1	0,6	27,5	
NJ 2304 EM	20	52	21	42	38,8	11000	14000	0,207	1,1	0,6	27,5	
NJ 2304 E	20	52	21	42	38,8	11000	14000	0,207	1,1	0,6	27,5	
NU 2304 EM	20	52	21	42	38,8	11000	14000	0,22	1,1	0,6	27,5	
NU 2304 E	20	52	21	42	38,8	11000	14000	0,207	1,1	0,6	27,5	
NUP 2304 EM	20	52	21	42	38,8	11000	14000	0,084	1,1	0,6	30,5	

Index other bore sizes

BEARING STEEL 100Cr6



Details part number:

- **No suffix:** steel cage & standard load ratings
- Suffix **E:** steel cage & increased load ratings
- Suffix **M:** brass cage & standard load ratings
- Suffix **EM:** brass cage & increased load ratings



Deep Groove Ball Bearing	Self-Aligning Ball Bearing	Angular Contact Ball Bearing	
<b>Cylindrical Roller Bearing</b>	Tapered Roller Bearing	Spherical Roller Bearing	
Thrust Ball Bearing	Spherical Roller Thrust Bearing	Accessories Adapter & Withdrawal Sleeve	Technical & Related Information



# 3 5 1 0 0 b

## Single Row Cylindrical Roller Bearing

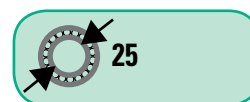
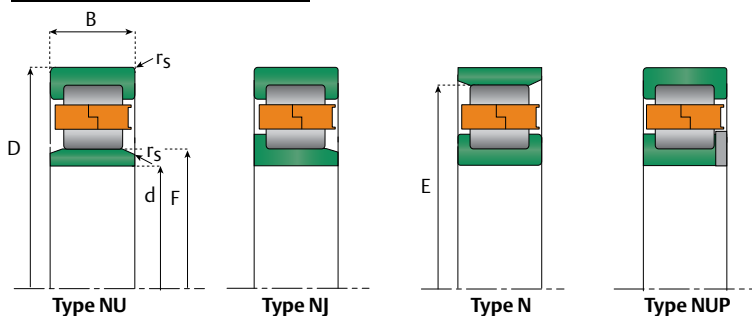

Click here for Technical & Related Information

Part number	Principal dimensions			Basic load ratings		Speed limits		Weight Kg	Radius		Dimensions	
	Bore	Outer	Width	Dynamic	Static	Grease	Oil		rS min	r1s min	F	E
	d	D	B	C	Co	rpm			mm		mm	
NU 1005	25	47	12	13,4	20,5	15000	18000	0,14	0,6	0,3	32,0	
N 205	25	52	15	17,7	15,7	12000	15000	0,16	1	0,6		31,5
NJ 205 E	25	52	15	28,5	26,7	12000	15000	0,14	1	0,6	31,5	
NJ 205 EM	25	52	15	28,5	26,7	12000	15000	0,14	1	0,6	31,5	
NU 205 E	25	52	15	28,5	26,7	12000	15000	0,14	1	0,6	31,5	
NU 205 EM	25	52	15	28,5	26,7	12000	15000	0,14	1	0,6	31,5	
NUP 205 E	25	52	15	28,5	26,7	12000	15000	0,14	1	0,6	31,5	
NJ 2205 E	25	52	18	34,6	34,3	11000	14000	0,16	1	0,6	31,5	
NJ 2205 EM	25	52	18	34,6	34,3	11000	14000	0,17	1	0,6	31,5	
NU 2205 E	25	52	18	34,6	34,3	11000	14000	0,17	1	0,6	31,5	
NU 2205 EM	25	52	18	34,6	34,3	11000	14000	0,17	1	0,6	31,5	
NUP 2205 E	25	52	18	34,6	34,3	11000	14000	0,16	1	0,6	31,5	
NUP 2205 EM	25	52	18	34,6	34,3	11000	14000	0,17	1	0,6	31,5	
N 305 EM	25	62	17	41,2	37	10000	13000	0,243	1,1	1,1		54,0
NJ 305 E	25	62	17	41,2	37	10000	13000	0,24	1,1	1,1	34,0	
NJ 305 M	25	62	17	37,3	35,9	9000	12000	0,28	1,1	1,1	35,0	
NJ 305 EM	25	62	17	41,2	37	10000	13000	0,243	1,1	1,1	34,0	
NU 305 E	25	62	17	29,3	25,2	10000	13000	0,243	1,1	1,1	34,0	
NU 305 EM	25	62	17	29,3	25,2	10000	13000	0,243	1,1	1,1	34,0	
NU 305 M	25	62	17	29,3	25,2	10000	13000	0,243	1,1	1,1	35,0	
NUP 305 M	25	62	17	31,7	31,2	10000	13000	0,3	1,1	1,1	34,0	
NUP 305 EM	25	62	17	41,2	37	10000	13000	0,3	1,1	1,1	34,0	
NJ 2305 E	25	62	24	56,7	55,7	9500	12000	0,348	1,1	1,1	34,0	
NJ 2305 EM	25	62	24	56,7	55,7	9500	12000	0,348	1,1	1,1	34,0	
NU 2305 EM	25	62	24	56,7	55,7	8500	12000	0,348	1,1	1,1	34,0	
NU 2305 E	25	62	24	56,7	55,7	9500	12000	0,34	1,1	1,1	34,0	
NUP 2305 E	25	62	24	56,7	55,7	9500	12000	0,352	1,1	1,1	34,0	
NU 405 M	25	80	24	50,6	44,4	8500	10000	0,61	1,5	1,5	38,8	
NUP 405 M	25	80	24	50,6	44,4	8500	10000	0,65	1,5	1,5	38,8	

Index other bore sizes

BEARING STEEL 100Cr6



Details part number:

- **No suffix:** steel cage & standard load ratings
- Suffix **E:** steel cage & increased load ratings
- Suffix **M:** brass cage & standard load ratings
- Suffix **EM:** brass cage & increased load ratings





Deep Groove Ball Bearing	Self-Aligning Ball Bearing	Angular Contact Ball Bearing	
<b>Cylindrical Roller Bearing</b>	Tapered Roller Bearing	Spherical Roller Bearing	
Thrust Ball Bearing	Spherical Roller Thrust Bearing	Accessories Adapter & Withdrawal Sleeve	Technical & Related Information



# 3 5 1 0 0 c

## Single Row Cylindrical Roller Bearing

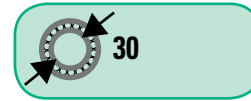
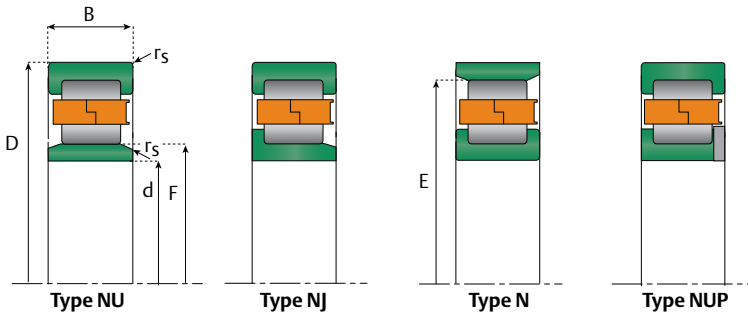

Click here for  
Technical & Related  
Information

Part number	Principal dimensions			Basic load ratings		Speed limits		Weight Kg	Radius		Dimensions	
	Bore	Outer	Width	Dynamic	Static	Grease	Oil		rS min	r1s min	F	E
	d	D	B	C	Co	rpm			mm		mm	
N 206 EM	30	62	16	39,7	37,9	10000	13000	0,26	1	0,6		55,5
NJ 206 E	30	62	16	40	37,9	10000	13000	0,2	1	0,6	37,5	
NJ 206 EM	30	62	16	40	37,9	10000	13000	0,2	1	0,6	37,5	
NU 206 E	30	62	16	39,7	37,9	10000	13000	0,206	1	0,6	37,5	
NU 206 EM	30	62	16	39,7	37,9	10000	13000	0,206	1	0,6	37,5	
NUP 206 EM	30	62	16	39,7	37,9	10000	13000	0,2	1	0,6	37,5	
NUP 206 E	30	62	16	39,7	37,9	10000	13000	0,2	1	0,6	37,5	
NU 206 M	30	62	16	23,4	21,5	10000	13000	0,2	1	0,6	38,5	
NJ 2206 EM	30	62	20	48,9	49,9	9000	11000	0,251	1	0,6	37,5	
NJ 2206 E	30	62	20	48,9	49,9	9000	11000	0,255	1	0,6	37,5	
NU 2206 M	30	62	20	48	53,9	7500	11000	0,3	1	0,6	37,5	
NU 2206 EM	30	62	20	48,9	49,9	9000	11000	0,26	1	0,6	37,5	
NU 2206 E	30	62	20	48,9	49,9	9000	11000	0,255	1	0,6	37,5	
NUP 2206 E	30	62	20	48,9	49,9	9000	11000	0,255	1	0,6	37,5	
NJ 306 E	30	72	19	50,5	47	8500	10000	0,35	1,1	1,1	40,5	
NJ 306 EM	30	72	19	50,5	47	8500	10000	0,37	1,1	1,1	40,5	
NU 306 E	30	72	19	50,5	47	8500	10000	0,37	1,1	1,1	40,5	
NU 306 EM	30	72	19	50,5	47	8500	10000	0,37	1,1	1,1	40,5	
NU 306 M	30	72	19	38,7	35,2	8500	10000	0,37	1,1	1,1	42,0	
NUP 306 E	30	72	19	50,5	47	8500	10000	0,38	1,1	1,1	40,5	
N 2306	30	72	27	51,4	50,8	8500	10000	0,53	1,1	1,1		62,0
NJ 2306 EM	30	72	27	71,9	74	8500	10000	0,52	1,1	1,1	40,5	
NJ 2306 E	30	72	27	71,9	74	8500	10000	0,52	1,1	1,1	40,5	
NU 2306 E	30	72	27	71,9	74	8500	10000	0,5	1,1	1,1	40,5	
NUP 2306 E	30	72	27	71,9	74	8500	10000	0,53	1,1	1,1	40,5	
NUP 2306 EM	30	72	27	71,9	74	8500	10000	0,53	1,1	1,1	40,5	
NUP 2306 M	30	72	27	51,4	50,8	8500	10000	0,53	1,1	1,1	42,0	
NJ 406 M	30	90	23	65	57,8	7500	9000	0,867	1,5	1,5	45,0	
NU 406 M	30	90	23	65	57,8	7500	9000	0,867	1,5	1,5	45,0	

Index other bore sizes

BEARING STEEL 100Cr6



Details part number:

- No suffix: steel cage & standard load ratings
- Suffix **E**: steel cage & increased load ratings
- Suffix **M**: brass cage & standard load ratings
- Suffix **EM**: brass cage & increased load ratings



Deep Groove Ball Bearing	Self-Aligning Ball Bearing	Angular Contact Ball Bearing	
<b>Cylindrical Roller Bearing</b>	Tapered Roller Bearing	Spherical Roller Bearing	
Thrust Ball Bearing	Spherical Roller Thrust Bearing	Accessories Adapter & Withdrawal Sleeve	Technical & Related Information



# 35 100 d

## Single Row Cylindrical Roller Bearing

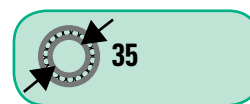
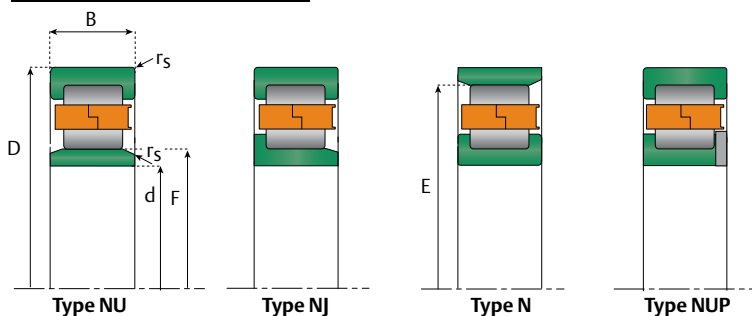

Click here for  
Technical & Related  
Information

Part number	Principal dimensions			Basic load ratings		Speed limits		Weight Kg	Radius		Dimensions	
	Bore	Outer	Width	Dynamic	Static	Grease	Oil		rS min	r1s min	F	E
	d	D	B	C	Co	rpm			mm		mm	
NU 1007	35	62	14	21,6	21,8	10000	13000	0,18	1	0,5	42,0	
N 207	35	72	17	33,6	31,5	9000	11000	0,303	1,1	0,6		61,8
NJ 207 E	35	72	17	49,9	49,7	9000	11000	0,303	1,1	0,6	44,0	
NJ 207 EM	35	72	17	49,9	49,7	9000	11000	0,303	1,1	0,6	44,0	
NJ 207 M	35	72	17	33,6	31,5	9000	11000	0,303	1,1	0,6	43,8	
NU 207 E	35	72	17	49,9	49,7	9000	11000	0,303	1,1	0,6	44,0	
NU 207 EM	35	72	17	49,9	49,7	9000	11000	0,303	1,1	0,6	44,0	
NUP 207 E	35	72	17	49,9	49,7	9000	11000	0,303	1,1	0,6	44,0	
NJ 2207 E	35	72	23	64,9	69,8	8000	9500	0,395	1,1	0,6	44,0	
NJ 2207 EM	35	72	23	64,9	69,8	8000	9500	0,395	1,1	0,6	44,0	
NJ 2207 M	35	72	23	49	51,3	8000	9500	0,395	1,1	0,6	43,8	
NU 2207 E	35	72	23	64,9	69,8	8000	9500	0,395	1,1	0,6	44,0	
NU 2207 EM	35	72	23	64,9	69,8	8000	9500	0,395	1,1	0,6	44,0	
NUP 2207 E	35	72	23	65,3	70,3	8000	9500	0,43	1,1	0,6	44,0	
N 307 E	35	80	21	63,8	61,6	8500	10000	0,47	1,5	1,1		70,2
N 307 EM	35	80	21	63,8	61,6	8500	10000	0,47	1,5	1,1		70,2
NJ 307 E	35	80	21	63,8	61,6	8500	10000	0,49	1,5	1,1	46,2	
NJ 307 EM	35	80	21	63,8	61,6	8500	10000	0,485	1,5	1,1	46,2	
NJ 307 M	35	80	21	47,3	44,1	8500	10000	0,485	1,5	1,1	46,2	
NU 307 E	35	80	21	63,8	61,6	8500	10000	0,485	1,5	1,1	46,2	
NU 307 EM	35	80	21	63,8	61,6	8500	10000	0,485	1,5	1,1	46,2	
NU 307 M	35	80	21	47,3	44,1	8500	10000	0,485	1,5	1,1	46,2	
NUP 307 E	35	80	21	63,8	61,6	8500	10000	0,485	1,5	1,1	46,2	
NUP 307 EM	35	80	21	63,8	61,6	8500	10000	0,485	1,5	1,1	46,2	
NJ 2307 E	35	80	31	85,5	89,9	7500	9000	0,727	1,5	1,1	46,2	
NJ 2307 M	35	80	31	58,3	57,6	7500	9000	0,72	1,5	1,1	46,2	
NU 2307 E	35	80	31	85,5	89,9	7500	9000	0,696	1,5	1,1	46,2	
NU 2307 M	35	80	31	58,3	57,6	7500	9000	0,72	1,5	1,1	46,2	
NUP 2307 E	35	80	31	85,5	89,9	7500	9000	0,696	1,5	1,1	46,2	
NJ 407 M	35	100	25	75,7	69,4	6700	8000	1,03	1,5	1,5	53,0	
NU 407 M	35	100	25	75,7	69,4	6700	8000	1,03	1,5	1,5	53,0	

Index other bore sizes

BEARING STEEL 100Cr6

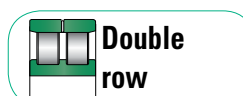
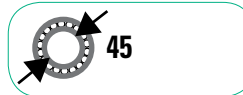

Details part number:

- **No suffix:** steel cage & standard load ratings
- Suffix **E:** steel cage & increased load ratings
- Suffix **M:** brass cage & standard load ratings
- Suffix **EM:** brass cage & increased load ratings





Deep Groove Ball Bearing	Self-Aligning Ball Bearing	Angular Contact Ball Bearing	
<b>Cylindrical Roller Bearing</b>	Tapered Roller Bearing	Spherical Roller Bearing	
Thrust Ball Bearing	Spherical Roller Thrust Bearing	Accessories Adapter & Withdrawal Sleeve	Technical & Related Information



# 3 5 1 0 0 e

## Single Row Cylindrical Roller Bearing

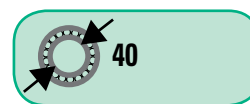
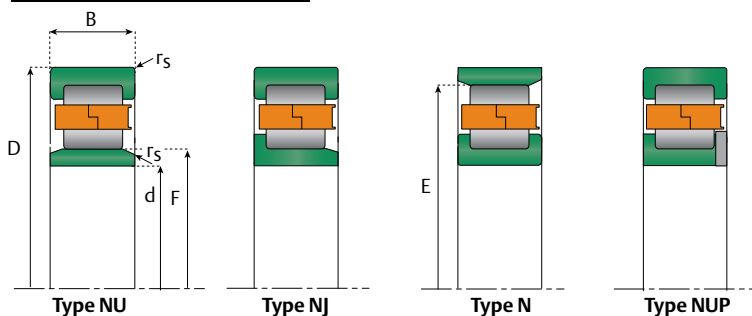

Click here for Technical & Related Information

Part number	Principal dimensions			Basic load ratings		Speed limits		Weight Kg	Radius		Dimensions	
	Bore	Outer	Width	Dynamic	Static	Grease	Oil		rS min	r1S min	F	E
	d	D	B	C	Co	rpm			mm		mm	
NU 1008 M	40	68	15	24	25,7	9500	12000	0,223	1	0,6	47,0	
N 208 EM	40	80	18	51,5	53	7000	9000	0,44	1,1	1,1		70,0
NJ 208 E	40	80	18	52,6	51,6	8000	9500	0,38	1,1	1,1	49,5	
NJ 208 EM	40	80	18	52,6	51,6	8000	9500	0,38	1,1	1,1	49,5	
NJ 208 M	40	80	18	43,7	42,9	8000	9500	0,38	1,1	1,1	50,0	
NU 208 EM	40	80	18	52,6	51,6	8000	9500	0,38	1,1	1,1	49,5	
NU 208 E	40	80	18	52,6	51,6	8000	9500	0,366	1,1	1,1	49,5	
NU 208 M	40	80	18	43,7	42,9	8000	9500	0,38	1,1	1,1	50,0	
NUP 208 E	40	80	18	52,6	51,6	8000	9500	0,38	1,1	1,1	49,5	
NUP 208 EM	40	80	18	52,6	51,6	8000	9500	0,38	1,1	1,1	49,5	
NJ 2208 E	40	80	23	70,3	74,8	7500	9000	0,5	1,1	1,1	49,5	
NJ 2208 EM	40	80	23	70,3	74,8	7500	9000	0,5	1,1	1,1	49,5	
NU 2208 EMA	40	80	23	70,3	74,8	7500	9000	0,56	1,1	1,1	49,5	
NUP 2208 E	40	80	23	70,3	74,8	7500	9000	0,49	1,1	1,1	49,5	
NUP 2208 EM	40	80	23	70,3	74,8	7500	9000	0,49	1,1	1,1	49,5	
N 308	40	90	23	56,2	53,8	7000	8500	0,66	1,5	1,5		77,5
NJ 308 E	40	90	23	79,9	77,5	7000	8500	0,68	1,5	1,5	52,0	
NJ 308 EM	40	90	23	79,9	77,5	7000	8500	0,68	1,5	1,5	52,0	
NJ 308 M	40	90	23	56,2	53,8	7000	8500	0,66	1,5	1,5	53,5	
NU 308 E	40	90	23	79,9	77,5	7000	8500	0,65	1,5	1,5	52,0	
NU 308 EM	40	90	23	79,9	77,5	7000	8500	0,65	1,5	1,5	52,0	
NU 308 M	40	90	23	56,2	53,8	7000	8500	0,66	1,5	1,5	53,5	
NUP 308 E	40	90	23	81,5	87,3	7000	8500	0,83	1,5	1,5	52,0	
NUP 308 EM	40	90	23	81,5	87,3	7000	8500	0,83	1,5	1,5	52,0	
NJ 2308 E	40	90	33	111	118	6700	8000	0,95	1,5	1,5	52,0	
NJ 2308 EM	40	90	33	111	118	6700	8000	0,95	1,5	1,5	52,0	
NU 2308 E	40	90	33	111	118	6700	8000	0,95	1,5	1,5	52,0	
NU 2308 EM	40	90	33	113	121	6700	8000	0,95	1,5	1,5	52,0	
NU 2308 M	40	90	33	80	84,9	6700	8000	0,95	1,5	1,5	53,5	
NUP 2308 E	40	90	33	111	118	6700	8000	0,95	1,5	1,5	52,0	
NUP 2308 EM	40	90	33	111	118	6700	8000	0,95	1,5	1,5	52,0	
N 408 M	40	110	27	93,8	86,8	6000	7000	1,31	2	2		92,0
NJ 408 M	40	110	27	93,8	86,8	6000	7000	1,31	2	2	58,0	
NU 408 M	40	110	27	93,8	86,8	6000	7000	1,31	2	2	58,0	
NUP 408 M	40	110	27	93,8	86,8	6000	7000	1,31	2	2	58,0	

Index other bore sizes

BEARING STEEL 100Cr6



Details part number:

- No suffix: steel cage & standard load ratings
- Suffix **E**: steel cage & increased load ratings
- Suffix **M**: brass cage & standard load ratings
- Suffix **EM**: brass cage & increased load ratings





Deep Groove Ball Bearing	Self-Aligning Ball Bearing	Angular Contact Ball Bearing	
<b>Cylindrical Roller Bearing</b>	Tapered Roller Bearing	Spherical Roller Bearing	
Thrust Ball Bearing	Spherical Roller Thrust Bearing	Accessories Adapter & Withdrawal Sleeve	Technical & Related Information



# 3 5 1 0 0 f

## Single Row Cylindrical Roller Bearing

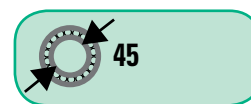
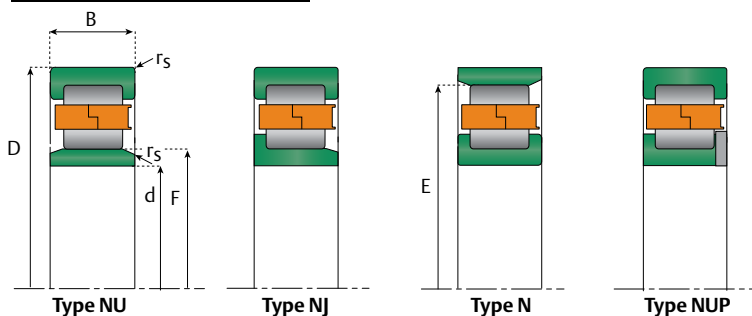

Click here for Technical & Related Information

Part number	Principal dimensions			Basic load ratings		Speed limits		Weight Kg	Radius		Dimensions	
	Bore	Outer	Width	Dynamic	Static	Grease	Oil		rS min	r1s min	F	E
	d	D	B	C	Co	rpm			mm		mm	
NU 1009 M	45	75	16	31,4	34,8	9000	11000	0,289	1	0,6	52,5	
N 209 M	45	85	19	46	46,9	7500	9000	0,445	1,1	1,1		75,0
NJ 209 EM	45	85	19	63	66,4	8000	6300	0,519	1,1	1,1	54,5	
NJ 209 E	45	85	19	60,2	62,8	7500	9000	0,445	1,1	1,1	54,5	
NU 209 E	45	85	19	60,2	62,8	7500	9000	0,427	1,1	1,1	54,5	
NUP 209 E	45	85	19	60,2	62,8	7500	9000	0,445	1,1	1,1	54,5	
NUP 209 EM	45	85	19	63	66,4	8000	6300	0,519	1,1	1,1	54,5	
NJ 2209 E	45	85	23	76,1	84,6	5500	8000	0,55	1,1	1,1	54,5	
NJ 2209 EM	45	85	23	76,1	84,6	5500	8000	0,55	1,1	1,1	54,5	
NJ 2209 M	45	85	23	61,2	67,8	7500	9000	0,53	1,1	1,1	55,0	
NU 2209 E	45	85	23	76,1	84,6	5500	8000	0,55	1,1	1,1	54,5	
NU 2209 EM	45	85	23	76,1	84,6	5500	8000	0,55	1,1	1,1	54,5	
NU 2209 M	45	85	23	61,2	67,8	7500	9000	0,53	1,1	1,1	55,0	
NUP 2209 E	45	85	23	73,9	81,6	7500	9000	0,53	1,1	1,1	54,5	
N 309 EM	45	100	25	96,9	97,7	6000	7000	0,895	1,5	1,5	58,5	
NJ 309 E	45	100	25	96,9	97,7	6000	7000	0,895	1,5	1,5	58,5	
NJ 309 EM	45	100	25	96,9	97,7	6000	7000	0,895	1,5	1,5	58,5	
NJ 309 M	45	100	25	71,2	67,8	6000	7000	0,895	1,5	1,5	58,5	
NU 309 E	45	100	25	96,9	97,7	6000	7000	0,87	1,5	1,5	58,5	
NU 309 EM	45	100	25	96,9	97,7	6000	7000	0,895	1,5	1,5	58,5	
NU 309 M	45	100	25	71,2	67,8	6000	7000	0,895	1,5	1,5	58,5	
NUP 309 E	45	100	25	96,9	97,7	6000	7000	0,895	1,5	1,5	58,5	
NUP 309 EM	45	100	25	96,9	97,7	6000	7000	0,895	1,5	1,5	58,5	
NJ 2309 EM	45	100	36	129,4	141,2	6000	7000	1,29	1,5	1,5	58,5	
NJ 2309 M	45	100	36	103	110	6000	7000	1,29	1,5	1,5	58,5	
NU 2309 M	45	100	36	103	110	6000	7000	1,29	1,5	1,5	58,5	
NU 2309 EM	45	100	36	129,4	141,2	6000	7000	1,29	1,5	1,5	58,5	
NUP 2309 E	45	100	36	130	142	6000	7000	1,25	1,5	1,5	58,5	
NUP 2309 EM	45	100	36	129,4	141,2	6000	7000	1,29	1,5	1,5	58,5	
NUP 2309 M	45	100	36	103	110	6000	7000	1,29	1,5	1,5	58,5	
N 409 M	45	120	29	104	97,8	5600	6700	1,66	2	2		100,5
NJ 409 M	45	120	29	121,2	111,5	5600	6700	1,87	1,5	1,5	64,5	
NU 409 M	45	120	29	104	97,8	5600	6700	1,66	2	2	64,5	
NUP 409 M	45	120	29	104	97,8	5600	6700	1,66	2	2	64,5	

Index other bore sizes

BEARING STEEL 100Cr6

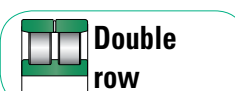

Details part number:

- No suffix: steel cage & standard load ratings
- Suffix E: steel cage & increased load ratings
- Suffix M: brass cage & standard load ratings
- Suffix EM: brass cage & increased load ratings





Deep Groove Ball Bearing	Self-Aligning Ball Bearing	Angular Contact Ball Bearing	
<b>Cylindrical Roller Bearing</b>	Tapered Roller Bearing	Spherical Roller Bearing	
Thrust Ball Bearing	Spherical Roller Thrust Bearing	Accessories Adapter & Withdrawal Sleeve	Technical & Related Information



# 3 5 1 0 0 h

## Single Row Cylindrical Roller Bearing

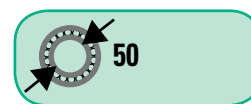
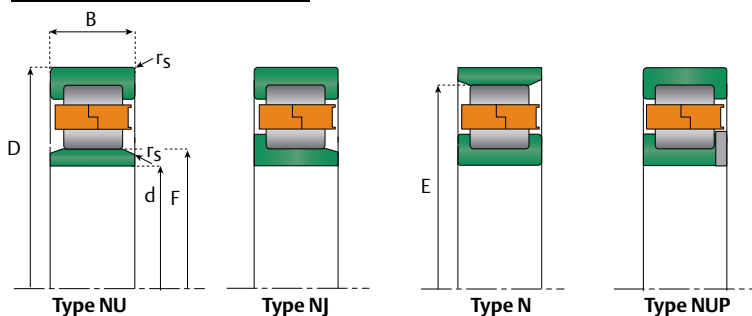

Click here for Technical & Related Information

Part number	Principal dimensions			Basic load ratings		Speed limits		Weight Kg	Radius		Dimensions	
	Bore	Outer	Width	Dynamic	Static	Grease	Oil		rS min	r1s min	F	E
	d	D	B	C	Co	rpm			mm		mm	
NJ 1010 M	50	80	16	32,1	36,1	8500	10000	0,32	1	0,6	57,5	
NU 1010 M	50	80	16	32,1	36,1	8500	10000	0,31	1	0,6	57,5	
NJ 210 EM	50	90	20	61,2	69,2	6000	7500	0,59				
NJ 210 E	50	90	20	63,7	68,3	6700	8000	0,499	1,1	1,1	59,5	
NJ 210 M	50	90	20	48,2	51	6700	8000	0,49	1,1	1,1	60,4	
NU 210 EM	50	90	20	63,7	68,3	6700	8000	0,48	1,1	1,1	59,5	
NU 210 E	50	90	20	63,7	68,3	6700	8000	0,49	1,1	1,1	59,5	
NUP 210 E	50	90	20	63,7	68,3	6700	8000	0,52	1,1	1,1	59,5	
NJ 2210 E	50	90	23	76,8	87,6	6900	8300	0,6	1,1	1,1	59,5	
NJ 2210 EM	50	90	23	76,8	87,6	6900	8300	0,6	1,1	1,1	59,5	
NJ 2210 M	50	90	23	61,8	70,2	6900	8300	0,575	1,1	1,1	60,4	
NU 2210 EM	50	90	23	76,8	87,6	6900	8300	0,58	1,1	1,1	59,5	
NU 2210 E	50	90	23	76,8	87,6	6900	8300	0,58	1,1	1,1	59,5	
NU 2210 M	50	90	23	61,8	70,2	6900	8300	0,575	1,1	1,1	60,4	
NUP 2210 E	50	90	23	76,8	87,6	6900	8300	0,6	1,1	1,1	59,5	
NUP 2210 EM	50	90	23	76,8	87,6	6900	8300	0,6	1,1	1,1	59,5	
NJ 310 E	50	110	27	110	112	6000	7000	1,14	2	2	65	
NJ 310 EM	50	110	27	119	125	5300	6700	1,34	2	2	65	
NJ 310 M	50	110	27	86,9	86,2	6000	7000	1,14	2	2	65	
NU 310 E	50	110	27	110	112	6000	7000	1,14	2	2	65,0	
NU 310 EM	50	110	27	110	112	6000	7000	1,14	2	2	65,0	
NUP 310 EM	50	110	27	110	112	6000	7000	1,14	2	2	65,0	
NUP 310 E	50	110	27	110	112	6000	7000	1,21	2	2	65,0	
NJ 2310 E	50	110	40	163	187	5300	6200	1,74	2	2	65	
NJ 2310 EM	50	110	40	163	187	5300	6200	1,74	2	2	65,0	
NU 2310 E	50	110	40	162	187	5300	6200	1,74	2	2	65,0	
NU 2310 EM	50	110	40	162	187	5300	6200	1,74	2	2	65,0	
NUP 2310 E	50	110	40	163	186	5300	6200	1,74	2	2	65,0	
N 410 M	50	130	31	139	136	4800	5600	2,01	2,1	2,1		110,8
NJ 410 M	50	130	31	139	136	4800	5600	2,08	2,1	2,1	70,8	
NU 410 M	50	130	31	139	136	4800	5600	2,01	2,1	2,1	70,8	

Index other bore sizes

BEARING STEEL 100Cr6

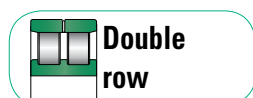
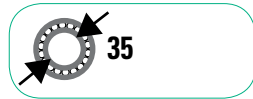

Details part number:

- **No suffix:** steel cage & standard load ratings
- **Suffix E:** steel cage & increased load ratings
- **Suffix M:** brass cage & standard load ratings
- **Suffix EM:** brass cage & increased load ratings





Deep Groove Ball Bearing	Self-Aligning Ball Bearing	Angular Contact Ball Bearing	
<b>Cylindrical Roller Bearing</b>	Tapered Roller Bearing	Spherical Roller Bearing	
Thrust Ball Bearing	Spherical Roller Thrust Bearing	Accessories Adapter & Withdrawal Sleeve	Technical & Related Information



# 3 5 2 0 0 a

## Single Row Cylindrical Roller Bearing

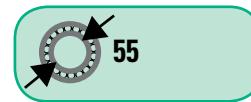
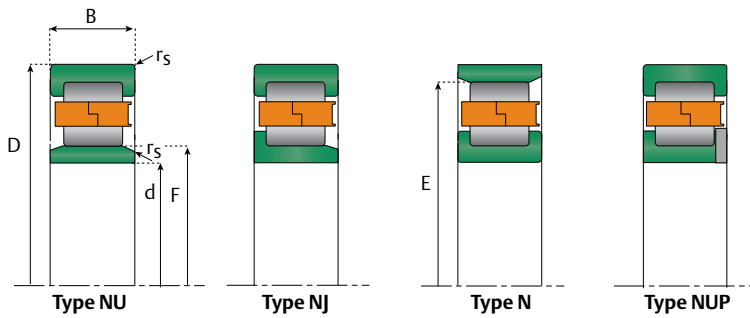

Click here for  
Technical & Related  
Information

Part number	Principal dimensions			Basic load ratings		Speed limits		Weight Kg	Radius		Dimensions	
	Bore	Outer	Width	Dynamic	Static	Grease	Oil		rS min	r1S min	F	E
	d	D	B	C	Co	rpm			mm		mm	
NU 1011 M	55	90	18	37,7	43,4	7800	9200	0,464	1,1	1	64,5	
N 211 M	55	100	21	57,9	62,5	6300	7500	0,665	1,5	1,1		88,5
NJ 211 E	55	100	21	82,6	93,4	6300	7500	0,66	1,5	1,1	66,0	
NJ 211 EM	55	100	21	82,6	93,4	6300	7500	0,66	1,5	1,1	66,0	
NU 211 E	55	100	21	82,6	93,4	6300	7500	0,665	1,5	1,1	66,0	
NU 211 EM	55	100	21	82,6	93,4	6300	7500	0,665	1,5	1,1	66,0	
NUP 211 E	55	100	21	82,6	93,4	6300	7500	0,665	1,5	1,1	66,0	
NUP 211 EM	55	100	21	82,6	93,4	6300	7500	0,665	1,5	1,1	66,0	
NJ 2211 M	55	100	25	76,3	89	6300	7500	0,78	1,5	1,1	66,5	
NU 2211 EM	55	100	25	98,9	118	6300	7500	0,78	1,5	1,1	66,0	
NU 2211 M	55	100	25	76,3	89	6300	7500	0,78	1,5	1,1	66,5	
NUP 2211 EM	55	100	25	98,9	118	6300	7500	0,85	1,5	1,1	66,0	
NUP 2211 E	55	100	25	101	121,5	6300	7500	0,85	1,5	1,5	66,0	
NJ 2211 E	55	110	25	98,9	118	6300	7500	0,78	1,1	2	66,0	
NJ 2211 EM	55	110	25	98,9	118	6300	7500	0,78	1,5	1,1	66,0	
N 311	55	120	29	109	109	5000	6000	1,47	2	2		104,5
NJ 311 E	55	120	29	134	138	5000	6000	1,44	2	2	70,5	
NJ 311 EM	55	120	29	134	138	5000	6000	1,47	2	2	70,5	
NJ 311 M	55	120	29	109	109	5000	6000	1,47	2	2	70,5	
NU 311 EM	55	120	29	134	138	5000	6000	1,47	2	2	70,5	
NU 311 EMA	55	120	29	134	138	5000	6000	1,47	2	2	70,5	
NUP 311 E	55	120	29	134	138	5000	6000	1,47	2	2	70,5	
NUP 311 EM	55	120	29	134	138	5000	6000	1,47	2	2	70,5	
NJ 2311 EM	55	120	43	148	162	4800	6000	2,86	2	2	70,5	
NJ 2311 M	55	120	43	146	159	4800	5700	2,23	2	2	70,5	
NU 2311 EM	55	120	43	187,3	213	4800	5600	2,5	2	2	70,5	
NU 2311 M	55	120	43	146	159	4800	5700	2,5	2	2	70,5	
NUP 2311 EM	55	120	43	187,3	213	4800	5600	2,5	2	2	70,5	
N 411	55	140	33	139	138	4300	5000	2,54	2,1	2,1		117,2
NJ 411 M	55	140	33	139	138	4300	5000	2,54	2,1	2,1	77,2	
NU 411 M	55	140	33	139	138	4300	5000	2,54	2,1	2,1	77,2	
NUP 411	55	140	33	139	138	4300	5000	2,51	2,1	2,1	77,2	

Index other bore sizes

BEARING STEEL 100Cr6



Details part number:

- No suffix: steel cage & standard load ratings
- Suffix **E**: steel cage & increased load ratings
- Suffix **M**: brass cage & standard load ratings
- Suffix **EM**: brass cage & increased load ratings





Deep Groove Ball Bearing	Self-Aligning Ball Bearing	Angular Contact Ball Bearing	
<b>Cylindrical Roller Bearing</b>	Tapered Roller Bearing	Spherical Roller Bearing	
Thrust Ball Bearing	Spherical Roller Thrust Bearing	Accessories Adapter & Withdrawal Sleeve	Technical & Related Information



# 3 5 2 0 0 b

## Single Row Cylindrical Roller Bearing

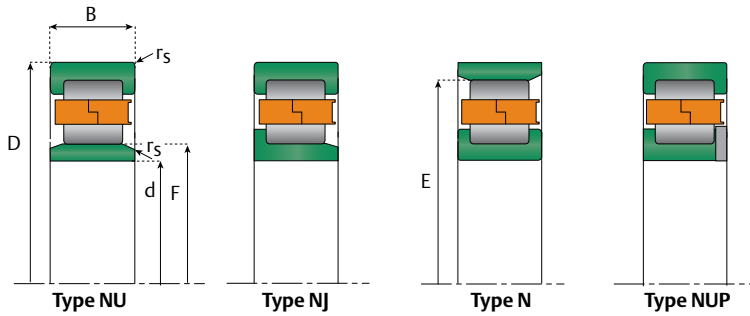

Click here for Technical & Related Information

Part number	Principal dimensions			Basic load ratings		Speed limits		Weight Kg	Radius		Dimensions	
	Bore	Outer	Width	Dynamic	Static	Grease	Oil		rS min	r1s min	F	E
	d	D	B	C	Co	rpm			mm		mm	
NU 1012 EM	60	95	18	35,8	43,2	6700	8000	0,47	1,1	1	68,5	
NU 1012 M	60	95	18	35,8	43,2	6700	8000	0,48	1,1	1	69,5	
N 212 EM	60	110	22	93,4	101	5600	6700	0,825	1,5	1,5		100,0
NJ 212 E	60	110	22	93,4	101	5600	6700	0,825	1,5	1,5	72,0	
NJ 212 EM	60	110	22	93,4	101	5600	6700	0,825	1,5	1,5	72,0	
NU 212 E	60	110	22	93,4	101	5600	6700	0,825	1,5	1,5	72,0	
NU 212 EM	60	110	22	96,3	106	5600	6700	0,825	1,5	1,5	72,0	
NUP 212 E	60	110	22	93,4	101	5600	6700	0,87	1,5	1,5	72,0	
NJ 2212 EM	60	110	28	130	153	5000	6000	1,08	1,5	1,5	72,0	
NU 2212 E	60	110	28	128	153	5000	6000	1,08	1,5	1,5	72,0	
NU 2212 EM	60	110	28	128	153	5000	6000	1,08	1,5	1,5	72,0	
NUP 2212 EM	60	110	28	136	165	5000	6000	1,08	1,5	2,1	72,0	
NUP 2212 E	60	110	28	136	165	5000	6000	1,08	1,5	2,1	72,0	
N 312 M	60	130	31	121	123	4500	5300	1,85	2,1	2,1		113,0
NJ 312 E	60	130	31	148	155	4500	5300	1,88	2,1	2,1	77,0	
NJ 312 EM	60	130	31	148	155	4500	5300	1,88	2,1	2,1	77,0	
NJ 312 M	60	130	31	121	123	4500	5300	1,85	2,1	2,1	77,0	
NU 312 E	60	130	31	148	155	4500	5300	1,83	2,1	2,1	77,0	
NU 312 EM	60	130	31	148	155	4500	5300	1,83	2,1	2,1	77,0	
NU 312 M	60	130	31	121	123	4500	5300	1,85	2,1	2,1	77,0	
NUP 312 EM	60	130	31	148	155	4500	5300	1,85	2,1	2,1	77,0	
NUP 312 E	60	130	31	148	155	4500	5300	1,93	2,1	2,1	77,0	
NUP 312 M	60	130	31	121	123	4500	5300	1,85	2,1	2,1	77,0	
N 2312	60	130	46	166	185	4300	5000	2,78	2,1	2,1		223,0
NJ 2312 E	60	130	46	222	262	4300	5000	2,77	2,1	2,1	77,0	
NJ 2312 EM	60	130	46	222	262	4300	5000	2,77	2,1	2,1	77,0	
NJ 2312 EMA	60	130	46	222	262	4300	5000	2,77	2,1	2,1	77,0	
NU 2312 E	60	130	46	222	262	4300	5000	2,78	2,1	2,1	77,0	
NU 2312 EM	60	130	46	222	262	4300	5000	2,69	2,1	2,1	77,0	
NU 2312 M	60	130	46	166	185	4300	5000	2,78	2,1	2,1	77,0	
NUP 2312 E	60	130	46	222	262	4300	5000	2,78	2,1	2,1	77,0	
NUP 2312 EM	60	130	46	222	262	4300	5000	2,78	2,1	2,1	77,0	
NUP 2312 EMA	60	130	46	222	262	4300	5000	2,78	2,1	2,1	77,0	
NJ 412 M	60	150	35	178	184	4000	4800	3,07	2,1	2,1	83,0	
NU 412 M	60	150	35	178	184	4000	4800	2,78	2,1	2,1	83,0	
NUP 412 M	60	150	35	178	184	4000	4800	3,07	2,1	2,1	83,0	

Index other bore sizes

BEARING STEEL 100Cr6

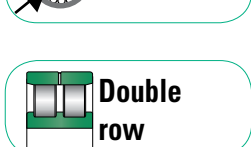
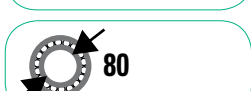

Details part number:

- No suffix: steel cage & standard load ratings
- Suffix **E**: steel cage & increased load ratings
- Suffix **M**: brass cage & standard load ratings
- Suffix **EM**: brass cage & increased load ratings



Deep Groove Ball Bearing	Self-Aligning Ball Bearing	Angular Contact Ball Bearing	
<b>Cylindrical Roller Bearing</b>	Tapered Roller Bearing	Spherical Roller Bearing	
Thrust Ball Bearing	Spherical Roller Thrust Bearing	Accessories Adapter & Withdrawal Sleeve	Technical & Related Information



# 3 5 2 0 0 c

## Single Row Cylindrical Roller Bearing

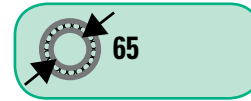
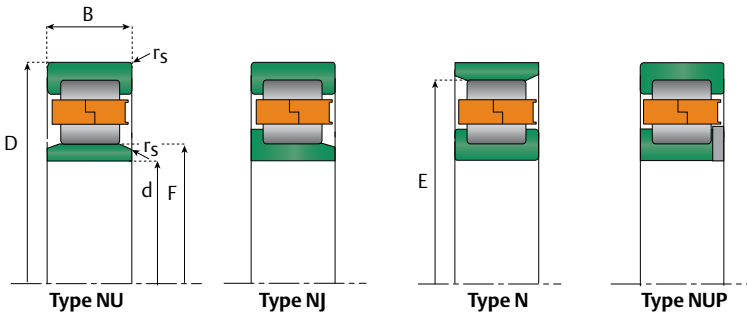

Click here for Technical & Related Information

Part number	Principal dimensions			Basic load ratings		Speed limits		Weight Kg	Radius		Dimensions	
	Bore	Outer	Width	Dynamic	Static	Grease	Oil		rS min	r1s min	F	E
	d	D	B	C	Co	rpm			mm		mm	
NU 1013 M	65	100	18	39,2	49	6600	7800	3,07	1,1	1	74,5	
N 213	65	120	23	80,5	89,7	5300	6300	1,05	1,5	1,5		105,6
NJ 213 E	65	120	23	107	118	5300	6300	1,07	1,5	1,5	78,5	
NJ 213 EM	65	120	23	107	118	5300	6300	1,07	1,5	1,5	78,5	
NU 213 E	65	120	23	107	118	5300	6300	1,05	1,5	1,5	78,5	
NU 213 EM	65	120	23	115,9	120	5300	6300	1,05	1,5	1,5	78,5	
NU 213 M	65	120	23	80,5	89,7	5300	6300	1,05	1,5	1,5	79,6	
NUP 213 EM	65	120	23	107	118	5300	6300	1,1	1,5	1,5	78,5	
NUP 213 E	65	120	23	107	118	5300	6300	1,05	1,5	1,5	78,5	
NUP 213 M	65	120	23	80,5	89,7	5300	6300	1,05	1,5	1,5	79,6	
NJ 2213 EM	65	120	31	145	178	4800	5600	1,65	1,5	1,5	78,5	
NU 2213 EM	65	120	31	145	178	4800	5600	1,65	1,5	1,5	78,5	
NUP 2213 EM	65	120	31	145	178	4800	5600	2,24	1,5	2,1	82,5	
N 313 EM	65	140	33	179	190	4300	5000	2,24	2,1	2,1		124,5
N 313 M	65	140	33	143	151	4300	5000	2,24	2,1	2,1		121,5
NJ 313 E	65	140	33	179	190	4300	5000	2,3	2,1	2,1	82,5	
NJ 313 EM	65	140	33	179	190	4300	5000	2,24	2,1	2,1	82,5	
NJ 313 M	65	140	33	143	151	4300	5000	2,24	2,1	2,1	83,5	
NU 313 E	65	140	33	179	190	4300	5000	1,65	2,1	2,1	78,5	
NU 313 EM	65	140	33	179	190	4300	5000	2,24	2,1	2,1	82,5	
NU 313 M	65	140	33	143	151	4300	5000	2,24	2,1	2,1	83,5	
NUP 313 E	65	140	33	179	190	4300	5000	2,37	2,1	2,1	82,5	
NUP 313 EM	65	140	33	179	190	4300	5000	2,37	2,1	2,1	82,5	
NJ 2313 EM	65	140	48	245	285	4000	4800	3,35	2,1	2,1	82,5	
NU 2313 E	65	140	48	245	285	4000	4800	3,31	2,1	2,1	82,5	
NU 2313 EM	65	140	48	245	285	4000	4800	3,31	2,1	2,1	82,5	
NUP 2313 EM	65	140	48	245	285	4000	4800	3,35	2,1	2,1	82,5	
NJ 413 M	65	160	37	195	203	3700	4500	3,68	2,1	2,1	89,3	
NU 413 M	65	160	37	195	203	3700	4500	3,68	2,1	2,1	89,3	
NUP 413 M	65	160	37	178,1	125,7	3700	4500	3,68	2,1	1,5	89,3	

[Index other bore sizes](#)  
**BEARING STEEL 100Cr6**

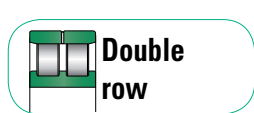

Details part number:

- **No suffix:** steel cage & standard load ratings
- **Suffix E:** steel cage & increased load ratings
- **Suffix M:** brass cage & standard load ratings
- **Suffix EM:** brass cage & increased load ratings



Deep Groove Ball Bearing	Self-Aligning Ball Bearing	Angular Contact Ball Bearing	
<b>Cylindrical Roller Bearing</b>	Tapered Roller Bearing	Spherical Roller Bearing	
Thrust Ball Bearing	Spherical Roller Thrust Bearing	Accessories Adapter & Withdrawal Sleeve	Technical & Related Information



# 3 5 2 0 0 d

## Single Row Cylindrical Roller Bearing

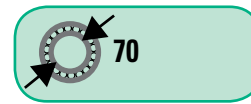
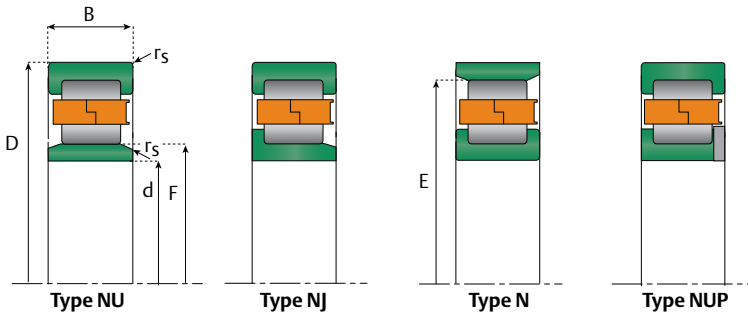

Click here for Technical & Related Information

Part number	Principal dimensions			Basic load ratings		Speed limits		Weight Kg	Radius		Dimensions	
	Bore	Outer	Width	Dynamic	Static	Grease	Oil		rS min	r1s min	F	E
	d	D	B	C	Co	rpm 1 min <sup>-1</sup>			mm		mm	
NU 1014 M	70	110	20	57,8	69,6	6000	7000	0,732	1,1	1	80,0	
N 214 E	70	125	24	118	136	5000	6000	1,15	1,5	1,5		133,5
N 214 EM	70	125	24	118	136	5000	6000	1,17	1,5	1,5		133,5
NJ 214 E	70	125	24	118	136	5000	6000	1,18	1,5	1,5	83,5	
NJ 214 EM	70	125	24	118	136	5000	6000	1,18	1,5	1,5	83,5	
NU 214 E	70	125	24	118	136	5000	6000	1,17	1,5	1,5	83,5	
NU 214 EM	70	125	24	118	136	5000	6000	1,17	1,5	1,5	83,5	
NU 214 M	70	125	24	83,7	96,1	5000	6000	1,17	1,5	1,5	84,5	
NUP 214 E	70	125	24	118	136	5000	6000	1,18	1,5	1,5	83,5	
NUP 214 EM	70	125	24	118	136	5000	6000	1,18	1,5	1,5	83,5	
NJ 2214 E	70	125	31	143	174	4800	5600	1,55	1,5	1,5	83,5	
NJ 2214 EM	70	125	31	143	174	4800	5600	1,52	1,5	1,5	83,5	
NJ 2214 M	70	125	31	122	155	4800	5600	1,52	1,5	1,5	84,5	
NU 2214 E	70	125	31	143	174	4800	5600	1,52	1,5	1,5	83,5	
NU 2214 EM	70	125	31	143	174	4800	5600	1,52	1,5	1,5	83,5	
NUP 2214 E	70	125	31	143	174	4800	5600	1,57	1,5	1,5	83,5	
NUP 2214 EM	70	125	31	157	197	4400	5300	1,7	1,5	1,5	83,5	
N 314 M	70	150	35	149	156	4000	4800	2,8	2,1	2,1		130,0
NJ 314 E	70	150	35	203	220	4000	4800	2,8	2,1	2,1	89,0	
NJ 314 EM	70	150	35	206	226	4000	4800	2,8	2,1	2,1	89,0	
NJ 314 M	70	150	35	149	156	4000	4800	2,8	2,1	2,1	90,0	
NU 314 EM	70	150	35	206	226	4000	4800	2,8	2,1	2,1	89,0	
NU 314 E	70	150	35	204	222	4000	4800	2,73	2,1	1,5	89,0	
NU 314 M	70	150	35	149	156	4000	4800	2,8	2,1	2,1	90,0	
NUP 314 EM	70	150	35	206	226	4000	4800	2,8	2,1	2,1	89,0	
NUP 314ENM	70	150	35	206	226	4000	4800	2,8	2,1	2,1	89,0	
NUP 314 E	70	150	35	204	222	4000	4800	2,73	2,1	1,5	89,0	
NU 414 M	70	150	42	240	253	3400	4000	5,26	3	3	100,0	
NJ 2314 E	70	150	51	274	323	3800	4500	3,95	2,1	2,1	89,0	
NJ 2314 EM	70	150	51	274	323	3800	4500	4	2,1	2,1	89,0	
NJ 2314 M	70	150	51	210	242	3800	4500	4	2,1	2,1	90,0	
NU 2314 E	70	150	51	274	323	3800	4500	3,95	2,1	2,1	89,0	
NU 2314 EM	70	150	51	274	323	3800	4500	4	2,1	2,1	89,0	
NU 2314 M	70	150	51	210	242	3800	4500	4	2,1	2,1	90,0	
NUP 2314 E	70	150	51	274	323	3800	4500	3,95	2,1	2,1	89,0	
N 414 M	70	180	42	240	253	3400	4000	5,46	3	3	152,0	
NJ 414 M	70	180	42	240	253	3400	4000	5,28	3	3	100,0	
NUP 414 M	70	180	42	240	253	3400	4000	5,46	3	3	100,0	

Index other bore sizes  
BEARING STEEL 100Cr6

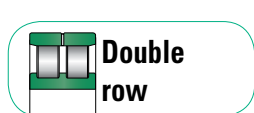
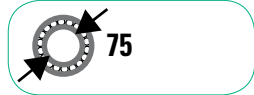

Details part number:

- No suffix: steel cage & standard load ratings
- Suffix **E**: steel cage & increased load ratings
- Suffix **M**: brass cage & standard load ratings
- Suffix **EM**: brass cage & increased load ratings



Deep Groove Ball Bearing	Self-Aligning Ball Bearing	Angular Contact Ball Bearing	
<b>Cylindrical Roller Bearing</b>	Tapered Roller Bearing	Spherical Roller Bearing	
Thrust Ball Bearing	Spherical Roller Thrust Bearing	Accessories Adapter & Withdrawal Sleeve	Technical & Related Information



# 3 5 2 0 0 e

## Single Row Cylindrical Roller Bearing

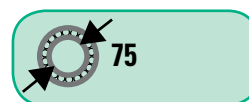
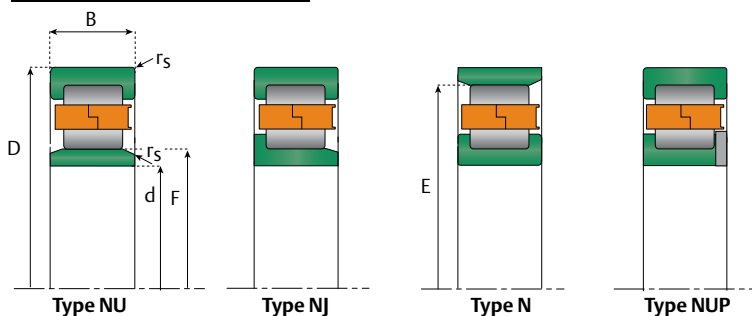

Click here for Technical & Related Information

Part number	Principal dimensions			Basic load ratings		Speed limits		Weight Kg	Radius		Dimensions	
	Bore	Outer	Width	Dynamic	Static	Grease	Oil		rS min	r1s min	F	E
	d	D	B	C	Co	rpm 1 min <sup>-1</sup>			mm		mm	
N 215 EM	75	130	25	129	155	4800	5600	1,24	1,5	1,5		118,5
NJ 215 E	75	130	25	129	155	4800	5600	1,28	1,5	1,5		88,5
NJ 215 EM	75	130	25	125	155	4000	5000	1,27	1,5	1,5		88,5
NU 215 E	75	130	25	129	155	4800	5600	1,28	1,5	1,5		88,5
NU 215 EM	75	130	25	129	155	4800	5600	1,28	1,5	1,5		88,5
NUP 215 E	75	130	25	129	155	4800	5600	1,31	1,5	1,5		88,5
NJ 2215	75	130	31	133	167	4000	4800	1,55	1,5	1,5		88,5
NU 2215 EM	75	130	31	151	190	4000	4800	1,8	1,5	1,5		88,5
NU 2215 M	75	130	31	133	167	4000	4800	1,6	1,5	1,5		88,5
NUP 2215	75	130	31	133	167	4000	4800	1,55	1,5	1,5		88,5
NUP 2215 EM	75	130	31	151	190	4000	4800	1,8	1,5	2,1		88,5
N 315 M	75	160	37	190	205	4000	4800	3,3	2,1	2,1		139,5
NJ 315 E	75	160	37	239	261	4000	4800	3,32	2,1	2,1		95,0
NJ 315 EM	75	160	37	239	261	4000	4800	3,3	2,1	2,1		95,0
NJ 315 M	75	160	37	190	205	4000	4800	3,3	2,1	2,1		95,5
NU 315 E	75	160	37	239	261	4000	4800	3,24	2,1	2,1		95,0
NU 315 EM	75	160	37	239	261	4000	4800	3,24	2,1	2,1		95,0
NU 315 M	75	160	37	190	205	4000	4800	3,3	2,1	2,1		95,5
NUP 315 E	75	160	37	239	261	4000	4800	3,3	2,1	2,1		95,0
NUP 315 EM	75	160	37	239	261	4000	4800	3,3	2,1	2,1		95,0
NJ 2315 EM	75	160	55	329	395	4000	4800	4,95	2,1	2,1		95,0
NJ 2315 E	75	160	55	329	395	4000	4800	4,95	2,1	2,1		95,0
NJ 2315 M	75	160	55	258	302	4000	4800	4,95	2,1	2,1		95,5
NU 2315 E	75	160	55	329	302	4000	4800	4,95	2,1	2,1		95,0
NU 2315 M	75	160	55	258	302	4000	4800	4,95	2,1	2,1		95,5
NJ 415 M	75	190	45	277	294	4000	4800	6,44	3	3		104,5
NU 415 M	75	190	45	277	294	4000	4800	6,44	3	3		104,5
NUP 415	75	190	45	277	294	4000	4800	6,44	3	3		104,5

Index other bore sizes

BEARING STEEL 100Cr6

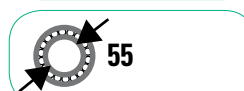

Details part number:

- No suffix: steel cage & standard load ratings
- Suffix **E**: steel cage & increased load ratings
- Suffix **M**: brass cage & standard load ratings
- Suffix **EM**: brass cage & increased load ratings



Deep Groove Ball Bearing	Self-Aligning Ball Bearing	Angular Contact Ball Bearing	
<b>Cylindrical Roller Bearing</b>	Tapered Roller Bearing	Spherical Roller Bearing	
Thrust Ball Bearing	Spherical Roller Thrust Bearing	Accessories Adapter & Withdrawal Sleeve	Technical & Related Information



# 3 5 2 0 0 f

## Single Row Cylindrical Roller Bearing

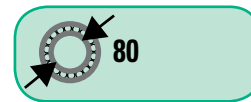
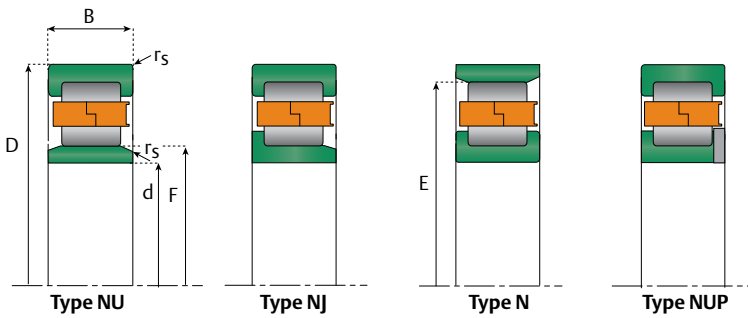

Click here for Technical & Related Information

Part number	Principal dimensions			Basic load ratings		Speed limits		Weight Kg	Radius		Dimensions	
	Bore	Outer	Width	Dynamic	Static	Grease	Oil		rS min	r1s min	F	E
	d	D	B	C	Co	rpm			mm		mm	
NJ 1016 M	80	125	22	80,95	104,5	5200	6200	1,03	1,1	1	91,5	
NU 1016 M	80	125	22	80,95	104,5	5200	6200	1,03	1,1	1	91,5	
N 216 E	80	140	26	139	166	4300	5000	1,51	2	2		127,3
N 216 EM	80	140	26	139	166	4300	5000	1,51	2	2		127,3
NJ 216 EM	80	140	26	142	171	4300	5000	1,54	2	2	95,3	
NU 216 E	80	140	26	139	166	4300	5000	1,51	2	2	95,3	
NU 216 EM	80	140	26	139	166	4300	5000	1,51	2	2	95,3	
NU 216 M	80	140	26	106	122	4300	5000	1,54	2	2	95,3	
NUP 216 E	80	140	26	139	166	4300	5000	1,6	2	2	95,3	
NUP 216 M	80	140	26	119	141	3800	4800	1,78	2	2	95,3	
NJ 2216 E	80	140	33	179	231	4300	5000	2	2	2	95,3	
NJ 2216 EM	80	140	33	179	231	4300	5000	2	2	2	95,3	
NJ 2216 M	80	140	33	147	186	4300	5000	2	2	2	95,3	
NU 2216 EM	80	140	33	179	231	4300	5000	2	2	2	95,3	
NU 2216 M	80	140	33	147	186	4300	5000	2	2	2	95,3	
NUP 2216 EM	80	140	33	179	231	4300	5000	2	2	2,1	95,3	
NUP 2216 M	80	140	33	147	186	4300	5000	2	2	2	95,3	
N 316 M	80	170	39	190	207	3600	4300	3,93	2,1	2,1		147,0
NJ 316 EM	80	170	39	253	277	3600	4300	4,02	2,1	2,1	101,0	
NJ 316 M	80	170	39	190	207	3600	4300	3,93	2,1	2,1	103,0	
NU 316 E	80	170	39	253	277	3600	4300	3,93	2,1	2,1	101,0	
NU 316 EM	80	170	39	253	277	3600	4300	3,93	2,1	2,1	101,0	
NU 316 M	80	170	39	190	207	3600	4300	3,93	2,1	2,1	103,0	
NUP 316 M	80	170	39	190	207	3600	4300	3,93	2,1	2,1	103,0	
N 2316	80	170	58	274	332	3600	4300	5,89	2,1	2,1		147,0
NJ 2316 E	80	170	58	353	426	3600	4300	5,89	2,1	2,1	101,0	
NJ 2316 M	80	170	58	274	332	3400	4200	5,89	2,1	2,1	103,0	
NU 2316 M	80	170	58	274	332	3400	4200	5,89	2,1	2,1	103,0	
NU 2316 EM	80	170	58	275	332	3400	4300	6,6	2,1	2,1	103,0	
NU 2316 EMA	80	170	58	353	426	3400	4300	6,7	2,1	2,1	103,0	
NUP 2316 M	80	170	58	274	332	3400	4200	5,89	2,1	2,1	103,0	
NJ 416 M	80	200	48	316	339	3000	3600	8,23	3	3	110,0	
NU 416 M	80	200	48	316	339	3000	3600	8,23	3	3	110,0	
NUP 416	80	200	48	316	339	3000	3600	8,23	3	3	110,0	
NUP 416 M	80	200	48	316	339	3000	3600	8,23	3	3	110,0	

Index other bore sizes

BEARING STEEL 100Cr6



### Details part number:

- No suffix: steel cage & standard load ratings
- Suffix **E**: steel cage & increased load ratings
- Suffix **M**: brass cage & standard load ratings
- Suffix **EM**: brass cage & increased load ratings



Deep Groove Ball Bearing	Self-Aligning Ball Bearing	Angular Contact Ball Bearing	
<b>Cylindrical Roller Bearing</b>	Tapered Roller Bearing	Spherical Roller Bearing	
Thrust Ball Bearing	Spherical Roller Thrust Bearing	Accessories Adapter & Withdrawal Sleeve	Technical & Related Information



# 3 5 2 0 0 h

## Single Row Cylindrical Roller Bearing

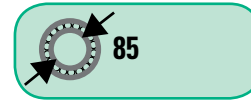
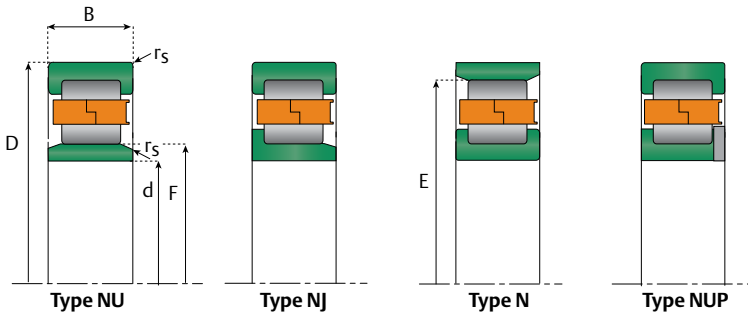

Click here for  
Technical & Related  
Information

Part number	Principal dimensions			Basic load ratings		Speed limits		Weight Kg	Radius		Dimensions	
	Bore	Outer	Width	Dynamic	Static	Grease	Oil		rS min	r1s min	F	E
	d	D	B	C	Co	rpm			mm		mm	
<b>N 1017 M</b>	85	130	22	70,6	89,8	4800	5700	1,89	1,1	1		96,5
<b>NU 1017 M</b>	85	130	22	70,6	89,8	4800	5700	1,066	1,1	1		96,5
<b>N 217 M</b>	85	150	28	121	141	4300	5000	1,9	2	2		133,8
<b>NJ 217 E</b>	85	150	28	164	194	4300	5000	1,95	2	2		100,5
<b>NJ 217 EM</b>	85	150	28	168	200	3600	4500	2,19	2	2		100,5
<b>NJ 217 M</b>	85	150	28	121	141	4300	5000	1,89	2	2		101,8
<b>NU 217 E</b>	85	150	28	164	194	4300	5000	1,89	2	2		100,5
<b>NU 217 EM</b>	85	150	28	164	194	4300	5000	1,89	2	2		100,5
<b>NU 217 M</b>	85	150	28	121	141	4300	5000	1,89	2	2		101,8
<b>NUP 217 E</b>	85	150	28	164	194	4300	5000	1,89	2	2		100,5
<b>NUP 217 EM</b>	85	150	28	164	194	4300	5000	1,89	2	2		100,5
<b>NUP 217 M</b>	85	150	28	121	141	4300	5000	1,89	2	2		101,8
<b>NJ 2217 E</b>	85	150	36	215	274	3600	4300	2,55	2	2		100,5
<b>NJ 2217 EM</b>	85	150	36	215	274	3600	4300	2,48	2	2		100,5
<b>NU 2217 EM</b>	85	150	36	215	274	3600	4300	2,48	2	2		100,5
<b>NUP 2217 EM</b>	85	150	36	219	281	3600	4300	2,9	2	2		100,5
<b>N 317 M</b>	85	180	41	210	226	3400	4000	4,68	3	3		156,0
<b>NJ 317 E</b>	85	180	41	288	325	3400	4000	4,64	3	3		108,0
<b>NJ 317 EM</b>	85	180	41	288	325	3400	4000	4,68	3	3		108,0
<b>NJ 317 M</b>	85	180	41	210	226	3400	4000	4,68	3	3		108,0
<b>NU 317 EM</b>	85	180	41	288	325	3400	4000	4,68	3	3		108,0
<b>NU 317 M</b>	85	180	41	210	226	3400	4000	4,52	3	3		108,0
<b>NUP 317 EM</b>	85	180	41	388	325	3400	4000	4,68	3	3		108,0
<b>NJ 2317 E</b>	85	180	60	368	446	3400	4000	6,88	3	3		108,0
<b>NJ 2317 EM</b>	85	180	60	368	446	3400	4000	6,85	3	3		108,0
<b>NJ 2317 M</b>	85	180	60	318	386	3200	4000	7,56	3	3		108,0
<b>NU 2317 E</b>	85	180	60	368	446	3400	4000	6,88	3	3		108,0
<b>NU 2317 EM</b>	85	180	60	368	446	3400	4000	6,85	3	3		108,0
<b>NU 2317 M</b>	85	180	60	351	441	3200	4000	7,51	3	3		108,0
<b>NUP 2317 EM</b>	85	180	60	368	446	3400	4000	6,85	3	3		108,0
<b>NJ 417 M</b>	85	210	52	357	384	2800	3400	9,81	4	4		113,0
<b>NU 417 M</b>	85	210	52	357	384	2800	3400	8,5	4	4		113,0

Index other bore sizes

BEARING STEEL 100Cr6

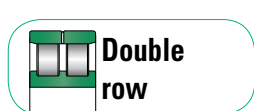

Details part number:

- **No suffix:** steel cage & standard load ratings
- Suffix **E:** steel cage & increased load ratings
- Suffix **M:** brass cage & standard load ratings
- Suffix **EM:** brass cage & increased load ratings



Deep Groove Ball Bearing	Self-Aligning Ball Bearing	Angular Contact Ball Bearing	
<b>Cylindrical Roller Bearing</b>	Tapered Roller Bearing	Spherical Roller Bearing	
Thrust Ball Bearing	Spherical Roller Thrust Bearing	Accessories Adapter & Withdrawal Sleeve	Technical & Related Information



### 3 5 3 0 0 a

## Single Row Cylindrical Roller Bearing

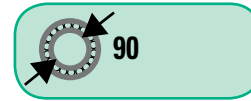
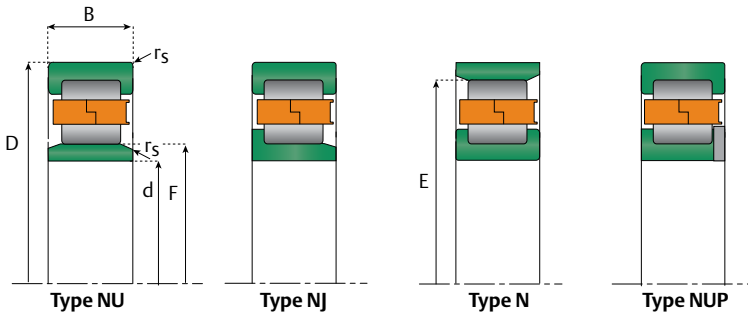

Click here for  
Technical & Related  
Information

Part number	Principal dimensions			Basic load ratings		Speed limits		Weight Kg	Radius		Dimensions	
	Bore	Outer	Width	Dynamic	Static	Grease	Oil		rS min	r1s min	F	E
	d	D	B	C	Co	rpm			mm		mm	
NU 1018 M	90	140	24	83,8	107	4500	5300	1,4	1,5	1,1	103,0	
N 218 EM	90	160	30	180	215	3800	4500	2,28	2	2		145,0
N 218 M	90	160	30	149	174	3800	4500	2,36	2	2		143,0
NJ 218 E	90	160	30	180	215	3800	4500	2,34	2	2	107,0	
NJ 218 EM	90	160	30	170	203	3400	4300	2,63	2	2	107,0	
NU 218 E	90	160	30	180	215	3800	4500	2,28	2	2	107,0	
NU 218 EM	90	160	30	180	215	3800	4500	2,28	2	2	107,0	
NU 218 M	90	160	30	149	174	3800	4500	2,28	2	2	107,0	
NUP 218 E	90	160	30	180	215	3800	4500	2,41	2	2	107,0	
NUP 218 EM	90	160	30	180	215	3800	4500	2,36	2	2	107,0	
NJ 2218 M	90	160	40	214	277	3200	3800	3,18	2	2	107,0	
NU 2218 M	90	160	40	214	277	3200	3800	3,18	2	2	107,0	
NUP 2218 M	90	160	40	214	277	3200	3800	3,18	2	2	107,0	
N 318 EM	90	190	43	322	261	3200	3800	5,38	3	3		169,5
N 318 M	90	190	43	237	261	3200	3800	5,38	3	3		165,0
NJ 318 E	90	190	43	322	349	3200	3800	5,42	3	3	113,5	
NJ 318 EM	90	190	43	322	349	3200	3800	5,42	3	3	113,5	
NJ 318 M	90	190	43	237	261	3200	3800	5,51	3	3	115,0	
NU 318 E	90	190	43	322	349	3200	3800	5,38	3	3	113,5	
NU 318 EM	90	190	43	322	349	3200	3800	5,38	3	3	113,5	
NU 318 M	90	190	43	237	261	3200	3800	5,42	3	3	115,0	
NUP 318 E	90	190	43	322	349	3200	3800	5,42	3	3	113,5	
NUP 318 EM	90	190	43	322	349	3200	3800	5,42	3	3	113,5	
NJ 2318 E	90	190	64	405	486	3000	3600	8,01	3	3	113,5	
NJ 2318 EM	90	190	64	289	349	3000	3800	8,7	3	3	113,5	
NJ 2318 M	90	190	64	342	420	3000	3600	8,01	3	3	115,0	
NU 2318 E	90	190	64	405	486	3000	3600	8,01	3	3	113,5	
NU 2318 EM	90	190	64	405	486	3000	3600	8,01	3	3	113,5	
NU 2318 M	90	190	64	342	420	3000	3600	7,9	3	3	115,0	
NUP 2318 E	90	190	64	405	486	3000	3600	8,01	3	3	115,0	
NUP 2318 M	90	190	64	342	420	3000	3600	8,25	3	3	115,0	
NJ 418 M	90	225	54	393	427	2200	2800	11,7	4	4	123,5	
NU 418 M	90	225	54	393	427	2800	3400	11,7	4	4	123,5	
NUP 418	90	225	54	393	427	2200	2800	11,7	4	4	115,0	

Index other bore sizes

BEARING STEEL 100Cr6



Details part number:

- No suffix: steel cage & standard load ratings
- Suffix **E**: steel cage & increased load ratings
- Suffix **M**: brass cage & standard load ratings
- Suffix **EM**: brass cage & increased load ratings



Deep Groove Ball Bearing	Self-Aligning Ball Bearing	Angular Contact Ball Bearing	
<b>Cylindrical Roller Bearing</b>	Tapered Roller Bearing	Spherical Roller Bearing	
Thrust Ball Bearing	Spherical Roller Thrust Bearing	Accessories Adapter & Withdrawal Sleeve	Technical & Related Information



Click here for  
Technical & Related  
Information

### 3 5 3 0 0 b

## Single Row Cylindrical Roller Bearing

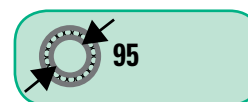
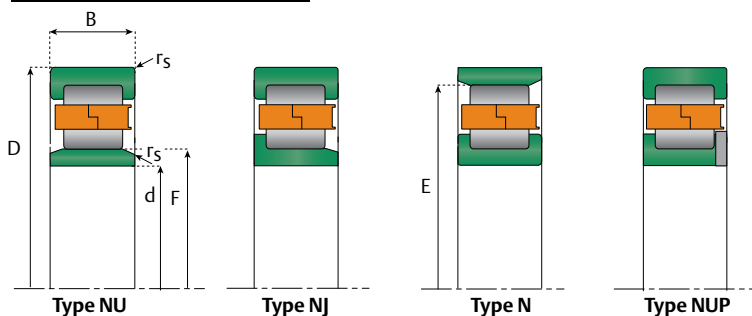

Part number	Principal dimensions			Basic load ratings		Speed limits		Weight Kg	Radius		Dimensions	
	Bore	Outer	Width	Dynamic	Static	Grease	Oil		rS min	r1s min	F	E
	d	D	B	C	Co	rpm			mm		mm	
NU 1019 M	95	145	24	85,3	114	4400	5200	1,44	1,5	1,1	108,0	
N 219	95	170	32	166	195	3800	4500	2,83	2,1	2,1		113,5
NJ 219 M	95	170	32	166	195	3800	4500	2,83	2,1	2,1	113,5	
NJ 219 EM	95	170	32	210	249	3800	4500	2,83	2,1	2,1	112,5	
NU 219 E	95	170	32	210	249	3800	4500	2,83	2,1	2,1	112,5	
NU 219 EM	95	170	32	210	249	3800	4500	2,83	2,1	2,1	112,5	
NU 219 M	95	170	32	116	195	3800	4500	2,83	2,1	2,1	113,5	
NUP 219 M	95	170	32	166	195	3800	4500	2,83	2,1	2,1	113,5	
NUP 219 EM	95	170	32	210	249	3800	4500	2,83	2,1	2,1	113,5	
NJ 2219 EM	95	170	43	272,7	348,8	3200	3800	3,93	2,1	2,1	113,5	
NJ 2219 M	95	170	43	241	317	3200	3800	3,83	2,1	2,1	113,5	
NU 2219 EM	95	170	43	272,7	348,8	3200	3800	3,93	2,1	2,1	113,5	
NU 2219 M	95	170	43	241	317	3200	3800	3,93	2,1	2,1	113,5	
NUP 2219 M	95	170	43	241	317	3200	3800	6,28	2,1	2,1	121,5	
N 319 M	95	200	45	255	284	3000	3600	6,28	3	3		173,5
NJ 319 E	95	200	45	331	381	3000	3600	6,28	3	3	121,5	
NJ 319 EM	95	200	45	351	370,5	3000	3600	7,15	3	3	121,5	
NJ 319 M	95	200	45	255	284	3000	3600	6,28	3	3	121,5	
NU 319 M	95	200	45	255	284	3000	3600	6,28	3	3	121,5	
NU 319 EM	95	200	45	351	370,5	3000	3600	7,76	3	3	121,5	
NUP 319	95	200	45	255	284	3000	3600	6,28	3	3	121,5	
N 2319 M	95	200	67	390	491	2800	3400	9,3	3	3		173,5
NJ 2319 M	95	200	67	390	491	2800	3400	3,93	3	3	121,5	
NJ 2319 EM	95	200	67	394	496	2800	3600	11,02	3	3	121,5	
NU 2319 M	95	200	67	390	491	2800	3400	3,93	3	3	121,5	
NUP 2319 M	95	200	67	390	491	2800	3400	9,3	3	3		121,5
N 419 M	95	240	55	416	465	2500	3000	13,8	4	4		133,5
NU 419 M	95	240	55	416	465	2500	3000	13,8	4	4	133,5	

Index other bore sizes

BEARING STEEL 100Cr6

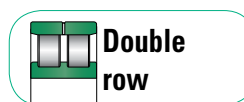

Details part number:

- **No suffix:** steel cage & standard load ratings
- Suffix **E:** steel cage & increased load ratings
- Suffix **M:** brass cage & standard load ratings
- Suffix **EM:** brass cage & increased load ratings





Deep Groove Ball Bearing	Self-Aligning Ball Bearing	Angular Contact Ball Bearing	
<b>Cylindrical Roller Bearing</b>	Tapered Roller Bearing	Spherical Roller Bearing	
Thrust Ball Bearing	Spherical Roller Thrust Bearing	Accessories Adapter & Withdrawal Sleeve	Technical & Related Information



# 3 5 3 0 0 c

## Single Row Cylindrical Roller Bearing

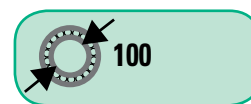
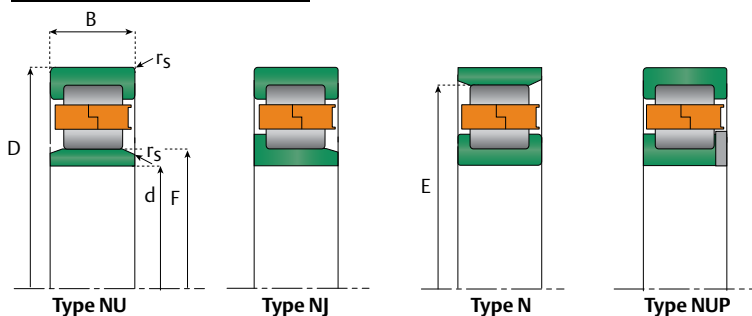

Click here for Technical & Related Information

Part number	Principal dimensions			Basic load ratings		Speed limits		Weight Kg	Radius		Dimensions	
	Bore	Outer	Width	Dynamic	Static	Grease	Oil		rS min	r1s min	F	E
	d	D	B	C	Co	rpm			mm		mm	
NU 1020 M	100	150	24	89,6	120	4300	5000	1,46	1,5	1,1	113,0	
NU 220 EM	100	180	34	253	311	3400	4000	3,91	2,1	2,1	119,0	
N 220 EM	100	180	34	251	305	3200	3800	3,45	2,1	2,1		
N 220 M	100	180	34	181	215	3400	4000	3,38	2,1	2,1	160,0	
NJ 220 EM	100	180	34	270,75	305,5	3200	3800	3,79	2,1	2,1	119,0	
NJ 220 E	100	180	34	248,6	305,5	3200	3800	5,55	2,1	2,1	119,0	
NJ 220 M	100	180	34	181	215	3400	4000	3,44	2,1	2,1	120,0	
NU 220 E	100	180	34	248,6	305,5	3200	3800	3,49	2,1	2,1	119,0	
NU 220 EM	100	180	34	270,75	305,5	3000	3800	3,14	2,1	2,1	119,0	
NU 220 M	100	180	34	181	215	3400	4000	3,47	2,1	2,1	120,0	
NUP 220 E	100	180	34	248,6	305,5	3200	3800	3,44	2,1	2,1	120,0	
NUP 220 M	100	180	34	181	215	3400	4000	3,44	2,1	2,1	120,0	
N 2220 EM	100	180	46	336	450	3200	3800	4,9				
NJ 2220 EM	100	180	46	326	472	3200	3800	5,43	2,1	2,1	119,0	
NJ 2220 M	100	180	46	270	360	3000	3600	4,67	2,1	2,1	120,0	
NU 2220 EM	100	180	46	336	450	3200	3800	4,75				
NU 2220 M	100	180	46	270	360	3000	3600	4,67	2,1	2,1	120,0	
NUP 2220 M	100	180	46	270	360	3000	3600	4,77	2,1	2,1	120,0	
N 320 EM	100	215	47	391	270	3000	3600	7,7	3	3		191,5
N 320 M	100	215	47	295	332	3000	3600	7,66	3	3		185,5
NJ 320 E	100	215	47	381	427	3000	3600	7,66	3	3	127,5	
NJ 320 EM	100	215	47	381	427	3000	3600	7,66	3	3	127,5	
NJ 320 M	100	215	47	295	332	3000	3600	7,7	3	3	129,5	
NU 320 EM	100	215	47	381	427	3000	3600	7,66	3	3	127,5	
NU 320 M	100	215	47	295	332	3000	3600	7,7	3	3	129,5	
NUP 320 M	100	215	47	295	332	3000	3600	7,66	3	3	129,5	
NJ 2320 E	100	215	73	568	714	2600	3200	12	3	3	127,5	
NJ 2320 EM	100	215	73	568	714	2600	3200	12	3	3	127,5	
NJ 2320 M	100	215	73	457	584	2600	3200	12	3	3	129,5	
NU 2320 EM	100	215	73	568	714	2600	3200	12	3	3	127,5	
NU 2320 M	100	215	73	457	584	2600	3200	11,9	3	3	129,5	
NUP 2320 M	100	215	73	457	584	2600	3200	14	3	3	139,0	
NJ 420 EM	100	250	58	429	475	2400	3000	14				
NJ 420 M	100	250	58	440	488	2200	2800	1,88	4	4	119,5	
NU 420 EM	100	250	58	429	475	2400	3000	14				
NU 420 M	100	250	58	440	488	2200	2800	14	4	4	139,0	

Index other bore sizes

BEARING STEEL 100Cr6

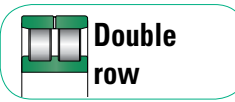

Details part number:

- No suffix: steel cage & standard load ratings
- Suffix **E**: steel cage & increased load ratings
- Suffix **M**: brass cage & standard load ratings
- Suffix **EM**: brass cage & increased load ratings





Deep Groove Ball Bearing	Self-Aligning Ball Bearing	Angular Contact Ball Bearing	
<b>Cylindrical Roller Bearing</b>	Tapered Roller Bearing	Spherical Roller Bearing	
Thrust Ball Bearing	Spherical Roller Thrust Bearing	Accessories Adapter & Withdrawal Sleeve	Technical & Related Information



Click here for Technical & Related Information

### 3 5 3 0 0 d

## Single Row Cylindrical Roller Bearing

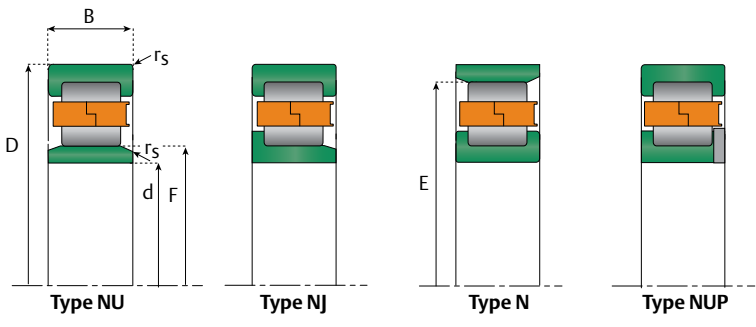

Part number	Principal dimensions			Basic load ratings		Speed limits		Weight Kg	Radius		Dimensions	
	Bore	Outer	Width	Dynamic	Static	Grease	Oil		rS min	r1s min	F	E
	d	D	B	C	Co	rpm			mm		mm	
NU 1021 M	105	160	26	101,5	135,3	3800	4500	4	2	1,1	126,8	
N 221 M	105	190	36	210	256	3200	3800	4,04	2,1	2,1		126,8
NJ 221 M	105	190	36	210	256	3200	3800	4,04	2,1	2,1		168,8
NU 221 M	105	190	36	210	256	3200	3800	4,04	2,1	2,1		126,8
N 321 M	105	225	49	354	408	2400	3000	9,09	3	3		195,0
NJ 321 M	105	225	49	354	408	2400	3000	9,09	3	3		135,0
NU 321 EM	105	225	49	418	469	2400	3000	9,09	3	3		133,0
NJ 421 M	105	260	60	488	545	2200	2800	17,4	4	4		144,5
NU 421 M	105	260	60	488	545	2200	2800	17,4	4	4		144,5
NUP 421 M	105	260	60	488	545	2200	2800	2,31	4	4		144,5
NU 1022 M	110	170	28	127	167	3600	4500	2,31	2	1,1		125,0
N 222 M	110	200	38	238	287	3000	3600	4,65	2,1	2,1		178,5
NJ 222 E	110	200	38	279	343	3000	3600	4,77	2,1	2,1		132,5
NJ 222 EM	110	200	38	303	343	3000	3600	4,85	2,1	2,1		132,5
NJ 222 M	110	200	38	238	287	3000	3600	4,65	2,1	2,1		132,5
NU 222 EM	110	200	38	303	343	3000	3600	4,77	2,1	2,1		132,5
NU 222 M	110	200	38	238	287	3000	3600	4,65	2,1	2,1		132,5
NUP 222 E	110	200	38	279	343	3000	3600	4,85	2,1	2,1		132,5
NUP 222 EM	110	200	38	303	343	3000	3600	4,85	2,1	2,1		132,5
NUP 222 M	110	200	38	238	287	3000	3600	4,65	2,1	2,1		132,5
N 2222 EM	110	200	53	348	513	2800	3400	7,1				
NJ 2222 EM	110	200	53	383	516	2800	3200	6,68	2,1	2,1		132,5
NJ 2222 M	110	200	53	350	471	2600	3200	6,68	2,1	2,1		132,5
NU 2222 EM	110	200	53	383	516	2800	3400	6,68	2,1	2,1		132,5
NU 2222 M	110	200	53	350	471	2600	3200	6,68	2,1	2,1		132,5
NUP 2222 M	110	200	53	350	471	2600	3200	7,14	2,1	2,1		132,5
N 322 EM	110	240	50	409,4	575,3	2000	2600	11,34				
NJ 322 E	110	240	50	443	513	2400	3000	10,6	3	3		143,0
NJ 322 EM	110	240	50	443	513	2400	3000	10,6	3	3		143,0
NJ 322 M	110	240	50	382	437	2400	3000	10,6	3	3		143,0
NU 322 E	110	240	50	443	513	2400	3000	10,6	3	3		143,0
NU 322 EM	110	240	50	443	513	2400	3000	10,6	3	3		143,0
NU 322 M	110	240	50	382	437	2400	3000	10,6	3	3		143,0
NUP 322 E	110	240	50	443	513	2400	3000	10,6	3	3		143,0
NUP 322 EM	110	240	50	485	577	2400	3000	10,6	3	3		143,0
NUP 322 M	110	240	50	382	437	2400	3000	10,6	3	3		143,0
N 2322 EM	110	240	80	682	900	2000	2600	18,23				
N 2322 M	110	240	80	603	789	2200	2800	16,9	3	3		207,0
NJ 2322 E	110	240	80	667	868	2200	2800	16,9	3	3		143,0
NJ 2322 EM	110	240	80	667	868	2200	2800	16,9	3	3		143,0
NJ 2322 M	110	240	80	603	789	2200	2800	16,9	3	3		143,0
NU 2322 EM	110	240	80	667	868	2200	2800	19	3	3		143,0
NU 2322 M	110	240	80	603	789	2200	2800	16,9	3	3		143,0
NUP 2322 M	110	240	80	604	789	2200	2800	16,9	3	3		143,0
NJ 422 EM	110	280	65	523	585	2000	2600	20				
NJ 422 M	110	280	65	583	672	2200	2800	20,8	4	4		155,0
NU 422 EM	110	280	65	523	585	2000	2600	20				
NU 422 M	110	280	65	583	672	2200	2800	20,8	4	4		155,0
NUP 422 M	110	280	65	583	672	2200	2400	20,8	4	4		155,0

Index other bore sizes

BEARING STEEL 100Cr6

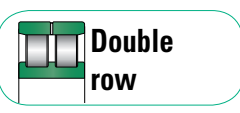
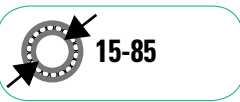

Details part number:

- No suffix: steel cage & standard load ratings
- Suffix E: steel cage & increased load ratings
- Suffix M: brass cage & standard load ratings
- Suffix EM: brass cage & increased load ratings





Deep Groove Ball Bearing	Self-Aligning Ball Bearing	Angular Contact Ball Bearing	
<b>Cylindrical Roller Bearing</b>	Tapered Roller Bearing	Spherical Roller Bearing	
Thrust Ball Bearing	Spherical Roller Thrust Bearing	Accessories Adapter & Withdrawal Sleeve	Technical & Related Information



### 3 5 3 0 0 e

## Single Row Cylindrical Roller Bearing

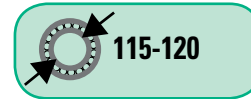
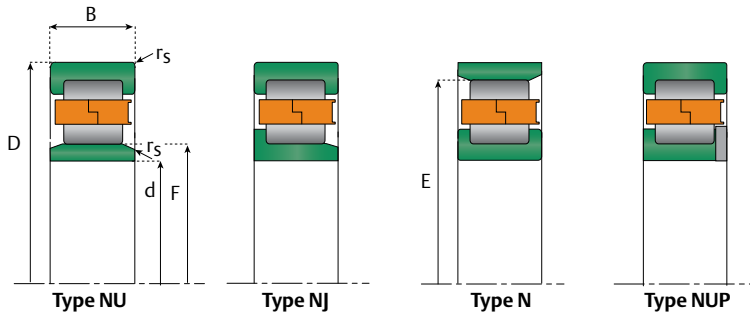

Click here for Technical & Related Information

Part number	Principal dimensions			Basic load ratings		Speed limits		Weight Kg	Radius		Dimensions	
	Bore	Outer	Width	Dynamic	Static	Grease	Oil		rS min	r1s min	F	E
	d	D	B	C	Co	rpm			mm		mm	
NJ 323 M	115	250	53	476	547	2700	3300	13,3	3	3	149,5	
N 1024 M	120	180	28	139	192	3400	4000	2,55	2	1,1		165,0
NU 1024 M	120	180	28	139	192	3400	4000	2,55	2	1,1	135,0	
N 224 EM	120	215	40	370,5	461	2400	3000	6,3			143,5	
N 224 M	120	215	40	258	361	2800	3400	5,65	2,1	2,1		191,5
NJ 224 E	120	215	40	331	415	2800	3400	5,8	2,1	2,1	143,5	
NJ 224 EM	120	215	40	370,5	461	2800	3400	5,54	2,1	2,1	143,5	
NJ 224 M	120	215	40	258	361	2800	3400	5,54	2,1	2,1	143,5	
NU 224 EM	120	215	40	370,5	461	2400	3000	6,35			143,5	
NU 224 M	120	215	40	258	361	2800	3400	5,65	2,1	2,1	143,5	
NUP 224 M	120	215	40	258	361	2800	3400	5,65	2,1	2,1	143,5	
NJ 2224 EM	120	215	58	443	658	2400	3000	9,53	2,1	2,1	143,5	
NJ 2224 M	120	215	58	382	523	2400	3000	8,29	2,1	2,1	143,5	
NU 2224 EM	120	215	58	413	622	2400	3000	9			143,5	
NU 2224 M	120	215	58	382	523	2400	3000	8,29	2,1	2,1	143,5	
NUP 2224 M	120	215	58	382	523	2400	3000	8,29	2,1	2,1	143,5	
WJ120/240 M	120	240	80	150	946	1484	2400	34,7	3		150,0	
WJP 120/240 M	120	240	80	150	946	1484	2400	34,7	3		150,0	
N 324 EM	120	260	55	549	644	2200	2800	13,1	3	3		230,0
N 324 M	120	260	55	441	498	2200	2800	13,1	3	3		226,0
NJ 324 EM	120	260	55	549	644	2200	2800	13,3	3	3	154,0	
NJ 324 M	120	260	55	441	498	2200	2800	13,3	3	3	154,0	
NU 324 EM	120	260	55	549	644	2200	2800	13,3	3	3	154,0	
NU 324 M	120	260	55	441	498	2200	2800	13,4	3	3	154,0	
NUP 324 EM	120	260	55	549	644	2200	2800	13,7	3	3	154,0	
NUP 324 M	120	260	55	441	498	2200	2800	13,1	3	3	154,0	
NJ 2324 EM	120	260	86	765,7	1080,9	1900	2400	24,03				
NJ 2324 M	120	260	86	702	907	2000	2600	23,2	3	3	154,0	
NU 2324 EM	120	260	86	765,7	1080,9	1900	2400	23,71				
NU 2324 M	120	260	86	702	907	2000	2600	23,2	3	3	154,0	
NUP 2324 M	120	260	86	702	907	2000	2600	30,6	3	3	154,0	
N 424 M	120	310	72	677	776	1800	2200	30,6	5	5		260,0
NJ 424 EM	120	310	72	644	735	1900	2400	28,5				
NJ 424 M	120	310	72	677	776	1800	2200	30,6	5	5	260,0	
NU 424 EM	120	310	72	644	735	1900	2400	28				
NU 424 M	120	310	72	677	776	1800	2200	30,6	5	5	260,0	

Index other bore sizes

BEARING STEEL 100Cr6



Details part number:

- No suffix: steel cage & standard load ratings
- Suffix **E**: steel cage & increased load ratings
- Suffix **M**: brass cage & standard load ratings
- Suffix **EM**: brass cage & increased load ratings



Deep Groove Ball Bearing	Self-Aligning Ball Bearing	Angular Contact Ball Bearing	
<b>Cylindrical Roller Bearing</b>	Tapered Roller Bearing	Spherical Roller Bearing	
Thrust Ball Bearing	Spherical Roller Thrust Bearing	Accessories Adapter & Withdrawal Sleeve	Technical & Related Information



# 3 5 3 0 0 f

## Single Row Cylindrical Roller Bearing

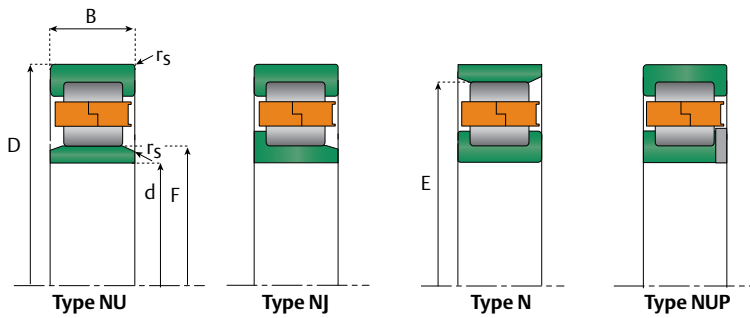

Click here for Technical & Related Information

Part number	Principal dimensions			Basic load ratings		Speed limits		Weight Kg	Radius		Dimensions	
	Bore	Outer	Width	Dynamic	Static	Grease	Oil		rS min	r1s min	F	E
	d	D	B	C	Co	rpm			mm		mm	
NJ 1026 M	130	200	33	162	221	3000	3600	3,91	2	1,1	148,0	
NU 1026 M	130	200	33	163	221	3000	3600	3,91	2	1,1	148,0	
N 226 EM	130	230	40	326	446	2200	2800	7				
N 226 M	130	230	40	268	339	2400	3000	6,79	3	3		204,0
NJ 226 E	130	230	40	356	443	2400	3000	6,79	3	3	153,5	
NJ 226 EM	130	230	40	356	443	2400	3000	6,79	3	3	153,5	
NJ 226 M	130	230	40	268	339	2400	3000	6,49	3	3	156,0	
NU 226 EM	130	230	40	356	443	2400	3000	6,5	3	3	153,5	
NU 226 M	130	230	40	268	339	2400	3000	6,64	3	3	156,0	
NUP 226 M	130	230	40	268	339	2400	3000	6,79	3	3	156,0	
NJ 2226 EM	130	230	64	523	726	2200	2800	10,3	3	3	153,5	
NJ 2226 M	130	230	64	395	560	2200	2800	10,3	3	3	156,0	
NJ 2226 MA	130	230	64	395	560	2200	2800	11,1	3	3	156,0	
NU 2226 EM	130	230	64	523	726	2200	2800	10,3	3	3	153,5	
NU 2226 M	130	230	64	395	560	2200	2800	10,3	3	3	156,0	
NUP 2226 M	130	230	64	395	560	2200	2800	10,3	3	3	156,0	
N 326 EM	130	280	58	607	722	2000	2600	16,4	4	4		247,0
N 326 M	130	280	58	520	607	2000	2600	16,5	4	4		243,0
NJ 326 E	130	280	58	607	722	2000	2600	16,8	4	4	167,0	
NJ 326 EM	130	280	58	624	747	2000	2600	18,5	4	4	167,0	
NJ 326 M	130	280	58	520	607	2000	2600	16,5	4	4	167,0	
NU 326 E	130	280	58	607	722	2000	2600	16,5	4	4	167,0	
NU 326 EM	130	280	58	607	722	2000	2600	16,5	4	4	167,0	
NU 326 M	130	280	58	520	607	2000	2600	16,5	4	4	167,0	
NUP 326 E	130	280	58	607	722	2000	2600	16,5	4	4	167,0	
NUP 326 EM	130	280	58	607	722	2000	2600	16,4	4	4	167,0	
NUP 326 M	130	280	58	520	607	2000	2600	16,9	4	4	167,0	
NJ 2326 EM	130	280	93	924	1212	1900	2400	29,6	4	4	167,0	
NJ 2326 M	130	280	93	828	1106	1900	2400	29,44	4	4	167,0	
NU 2326 EM	130	280	93	924	1212	1900	2400	29,6	4	4	167,0	
NU 2326 M	130	280	93	828	1106	1900	2400	29,6	4	4	167,0	
NUP 2326	130	280	93	828	1106	1900	2400	29,6	4	4	167,0	
NU 426 M	130	340	78	880	1040	1800	2200	39,1	5	5		

Index other bore sizes

BEARING STEEL 100Cr6

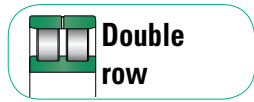

Details part number:

- No suffix: steel cage & standard load ratings
- Suffix **E**: steel cage & increased load ratings
- Suffix **M**: brass cage & standard load ratings
- Suffix **EM**: brass cage & increased load ratings



Deep Groove Ball Bearing	Self-Aligning Ball Bearing	Angular Contact Ball Bearing	
<b>Cylindrical Roller Bearing</b>	Tapered Roller Bearing	Spherical Roller Bearing	
Thrust Ball Bearing	Spherical Roller Thrust Bearing	Accessories Adapter & Withdrawal Sleeve	Technical & Related Information



# 3 5 3 0 0 h

## Single Row Cylindrical Roller Bearing

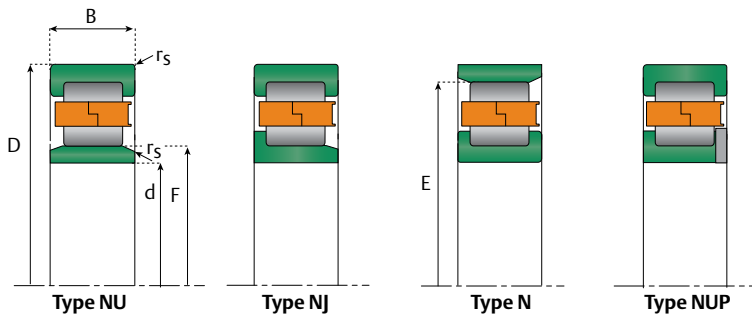

Click here for Technical & Related Information

Part number	Principal dimensions			Basic load ratings		Speed limits		Weight Kg	Radius		Dimensions	
	Bore	Outer	Width	Dynamic	Static	Grease	Oil		rS min	r1s min	F	E
	d	D	B	C	Co	rpm			mm		mm	
NJ 1028 M	140	210	33	172	243	2800	3200	4,1	2	1,1	158,0	
NU 1028 M	140	210	33	172	243	2800	3200	4,1	2	1,1	158,0	
N 228 EM	140	250	42	359	517	2000	2600	9,04				
NJ 228 EM	140	250	42	372	479	2200	2800	8,55	3	3	169,0	
NJ 228 M	140	250	42	307	391	2200	2800	8,55	3	3	169,0	
NU 228 EM	140	250	42	372	479	2200	2800	8,35	3	3	169,0	
NU 228 M	140	250	42	307	391	2200	2800	8,35	3	3	169,0	
NUP 228 EM	140	250	42	372	479	2200	2800	8,55	3	3	169,0	
NUP 228 M	140	250	42	307	391	2200	2800	8,55	3	3	169,0	
NJ 2228 EM	140	250	68	572	830	2000	2600	13,7				
NJ 2228 M	140	250	68	479	708	2000	2600	15,2	3	3	169,0	
NU 2228 EM	140	250	68	543	780	2000	2600	15,2	3	3	169,0	
NU 2228 M	140	250	68	479	708	2000	2600	15,2	3	3	169,0	
NUP 2228 M	140	250	68	479	708	2000	2600	15,2	3	3	169,0	
N 328 EM	140	300	62	610	1214	1800	2200	22				
N 328 M	140	300	62	607	732	1900	2400	20,1	4	4		260,0
NJ 328 EM	140	300	62	610	1214	1800	2200	22,45				
NJ 328 M	140	300	62	607	732	1900	2400	22,5	4	4	180,0	
NU 328 EM	140	300	62	703	861	1900	2400	20,2	4	4	180,0	
NU 328 M	140	300	62	607	732	1900	2400	20,2	4	4	180,0	
NUP 328 EM	140	300	62	703	861	1900	2400	20,1	4	4	180,0	
NUP 328 M	140	300	62	607	732	1900	2400	20,7	4	4	180,0	
NJ 2328 E	140	300	102	1130	1589	1800	2200	37,2	4	4	180,0	
NJ 2328 EM	140	300	102	1130	1589	1800	2200	37,2	4	4	180,0	
NJ 2328 M	140	300	102	913	1236	1800	2200	37,2	4	4	180,0	
NU 2328 EM	140	300	102	1060	1500	1800	2200	36,1				
NU 2328 M	140	300	102	913	1236	1800	2200	37,2	4	4	180,0	
NUP 2328 M	140	300	102	913	1236	1800	2200	37,2	4	4	180,0	
N 428 EM	140	360	82	868	1010	1300	1700	43,8				
NJ 428 EM	140	360	82	868	1010	1300	1700	44,76				
NU 428 EM	140	360	82	868	1010	1300	1700	44,07				

Index other bore sizes

BEARING STEEL 100Cr6

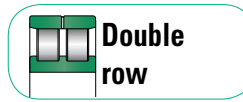

Details part number:

- **No suffix:** steel cage & standard load ratings
- Suffix **E:** steel cage & increased load ratings
- Suffix **M:** brass cage & standard load ratings
- Suffix **EM:** brass cage & increased load ratings





Deep Groove Ball Bearing	Self-Aligning Ball Bearing	Angular Contact Ball Bearing	
<b>Cylindrical Roller Bearing</b>	Tapered Roller Bearing	Spherical Roller Bearing	
Thrust Ball Bearing	Spherical Roller Thrust Bearing	Accessories Adapter & Withdrawal Sleeve	Technical & Related Information



### 3 5 4 0 0 a

## Single Row Cylindrical Roller Bearing

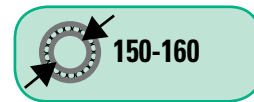
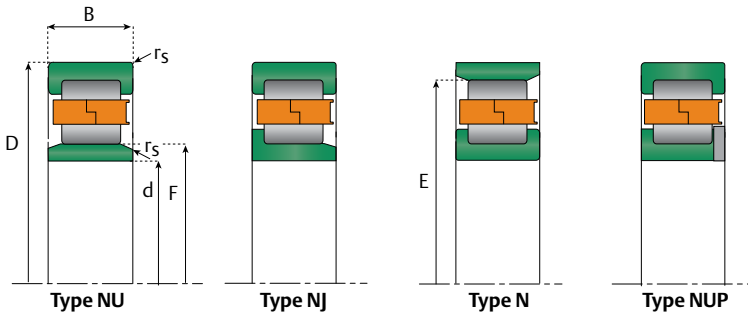

Click here for Technical & Related Information

Part number	Principal dimensions			Basic load ratings		Speed limits		Weight Kg	Radius		Dimensions	
	Bore	Outer	Width	Dynamic	Static	Grease	Oil		rS min	r1s min	F	E
	d	D	B	C	Co	rpm			mm		mm	
NU 1030 M	150	225	35	190	271	2600	3200	4,83	2,1	1,5	169,5	
N 230 EM	150	270	45	386,6	554,8	1900	2400	11,2				238,0
N 230 M	150	270	45	370	484	2000	2600	10,3	3	3		
NJ 230 EM	150	270	45	422	550	2200	2800	10,6	3	3	182,0	
NJ 230 M	150	270	45	370	484	2000	2600	10,6	3	3	182,0	
NU 230 EM	150	270	45	422	550	2200	2800	11,68	3	3	182,0	
NU 230 M	150	270	45	370	484	2000	2600	10,3	3	3	182,0	
NU 230 MA	150	270	45	370	484	2000	2600	10,3	3	3	182,0	
NUP 230 M	150	270	45	370	484	2000	2600	10,9	3	3	182,0	
NJ 2230 EM	150	270	73	573,7	922	1900	2400	18,61				
NJ 2230 M	150	270	73	565	836	1900	2400	19,2	3	3	182,0	
NU 2230 EM	150	270	73	573,7	922	1900	2400	18,25				
NU 2230 M	150	270	73	565	836	1900	2400	18,7	3	3	182,0	
NUP 2230 M	150	270	73	565	836	1900	2400	19,7	3	3	182,0	
N 330 EM	150	320	65	688	921	1700	2000	25,78				
NJ 330 EM	150	320	65	688	921	1700	2000	26,32				
NJ 330 M	150	320	65	667	813	1700	2000	27	4	4	193,0	
NU 330 EM	150	320	65	798	988	1700	2000	27	4	4	193,0	
NU 330 M	150	320	65	667	813	1700	2000	27	4	4	193,0	
NUP 330 M	150	320	65	667	813	1700	2000	27,4	4	4	193,0	
NJ 2230 EM	150	320	108	1055	1607	1700	2000	43,5				
NJ 2230 M	150	320	108	1022	1409	1700	2000	44,7	4	4	193,0	
NU 2230 EM	150	320	108	1055	1607	1700	2000	42,98				
NU 2230 M	150	320	108	1022	1409	1700	2000	44,7	4	4	193,0	
NJ 1032 M	160	240	38	230	331	2400	3000	6,2	2,1	1,5	180,0	
NU 1032 M	160	240	38	230	328	2400	3000	6,2	2,1	1,5	180,0	
N 232 EM	160	290	48	351	479	1800	2200	14,02				
NJ 232 EM	160	290	48	498	666	1900	2400	14,6	3	3	195,0	
NJ 232 M	160	290	48	440	591	1900	2400	14,6	3	3	195,0	
NU 232 EM	160	290	48	498	666	1900	2400	14,6	3	3	195,0	
NU 232 M	160	290	48	440	591	1900	2400	14,6	3	3	195,0	
NUP 232 EM	160	290	48	498	666	1900	2400	14,6	3	3	195,0	
NUP 232 M	160	290	48	440	591	1900	2400	14,6	3	3	195,0	
NJ 2232 EM	160	290	80	767	1109	1700	2000	24,3	3	3	193,0	
NJ 2232 M	160	290	80	650	978	1700	2000	24,3	3	3	195,0	
NU 2232 EM	160	290	80	706	1128	1800	2200	23,3				
NU 2232 M	160	290	80	650	978	1700	2000	24,3	3	3	195,0	
NUP 2232 M	160	290	80	650	978	1700	2000	24,3	3	3	195,0	
N 332 EM	160	340	68	738	978	1500	1800	30,3				
N 332 M	160	340	68	702	883	1500	1800	32	4	4	292,0	
NJ 332 EM	160	340	68	738	978	1500	1800	31,01				
NJ 332 M	160	340	68	702	883	1600	1900	31,7	4	4	208,0	
NU 332 EM	160	340	68	738	978	1500	1800	30,56				
NU 332 M	160	340	68	702	883	1600	1900	31,7	4	4	208,0	
NUP 332 M	160	340	68	702	883	1600	1900	32	4	4	208,0	
NJ 2332 EM	160	340	114	1128	1689	1500	1800	51,5				
NJ 2332 M	160	340	114	1069	1522	1600	1900	53,2	4	4	208,0	
NU 2332 EM	160	340	114	1128	1689	1500	1800	50,98				
NU 2332 M	160	340	114	1069	1522	1600	1900	53,2	4	4	208,0	

Index other bore sizes

BEARING STEEL 100Cr6

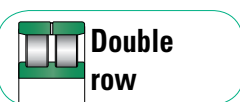

Details part number:

- No suffix: steel cage & standard load ratings
- Suffix **E**: steel cage & increased load ratings
- Suffix **M**: brass cage & standard load ratings
- Suffix **EM**: brass cage & increased load ratings





Deep Groove Ball Bearing	Self-Aligning Ball Bearing	Angular Contact Ball Bearing	
<b>Cylindrical Roller Bearing</b>	Tapered Roller Bearing	Spherical Roller Bearing	
Thrust Ball Bearing	Spherical Roller Thrust Bearing	Accessories Adapter & Withdrawal Sleeve	Technical & Related Information



# 3 5 4 0 0 b

## Single Row Cylindrical Roller Bearing

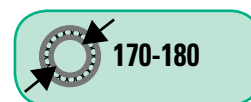
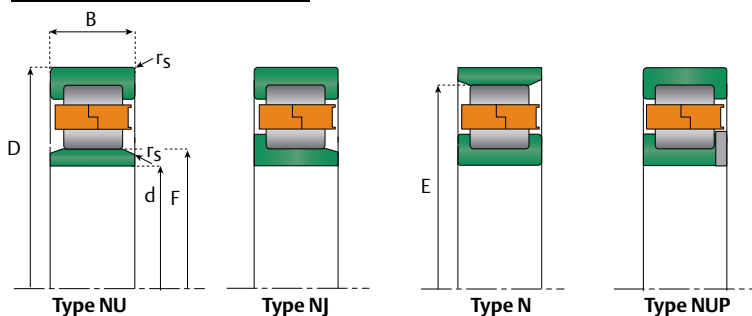

Click here for Technical & Related Information

Part number	Principal dimensions			Basic load ratings		Speed limits		Weight Kg	Radius		Dimensions	
	Bore	Outer	Width	Dynamic	Static	Grease	Oil		rS min	r1s min	F	E
	d	D	B	C	Co	rpm			mm		mm	
NJ 1034 M	170	260	42	277	400	2200	2800	8,36	2,1	2,1	193,0	
NU 1034 M	170	260	42	277	400	2200	2800	7,9	2,1	2,1	193,0	
N 234 EM	170	310	52	618	828	1800	2200	17,6	4	4		272,0
NJ 234 EM	170	310	52	520,4	747,8	1800	2200	17,96				
NJ 234 M	170	310	52	499	677	1800	2200	18,2	4	4	208,0	
NU 234 EM	170	310	52	618	828	1800	2200	17,6	4	4	207,0	
NU 234 M	170	310	52	499	677	1800	2200	18,1	4	4	208,0	
NUP 234 M	170	310	52	499	677	1800	2200	18,2	4	4	208,0	
N 2234 M	170	310	86	748	1141	1700	2000	29,8	4	4		272,0
NJ 2234 EM	170	310	86	820	1340	1800	2200	30,1				
NU 2234 EM	170	310	86	914	1316	1700	2000	28,57	4	4	205,0	
NU 2234 M	170	310	86	748	1141	1700	2000	29,8	4	4	208,0	
NUP 2234 EM	170	310	86	914	1316	1700	2000	29,8	4	4	205,0	
NUP 2234 M	170	310	86	748	1141	1700	2000	29,8	4	4	208,0	
NJ 2334 EM	170	360	10	1310	2030	1400	1700	62,28				
N 334 EM	170	360	72	809	1040	1400	1700	38,45				
NJ 334 EM	170	360	72	928	1149	1500	1800	38	4	4	215,0	
NJ 334 M	170	360	72	801	1018	1500	1800	38	4	4	220,0	
NU 334 EM	170	360	72	809	1040	1400	1700	38,5				
NU 334 M	170	360	72	801	1018	1500	1800	38	4	4	220,0	
NUP 334	170	360	72	801	1018	1600	1900	38	4	4	220,0	
NJ 2334 M	170	360	120	1226	1758	1400	1700	62,7	4	4	220,0	
NU 2334 EM	170	360	120	1310	2030	1400	1700	61,3				
NU 2334 M	170	360	120	1226	1758	1400	1700	62,7	4	4	220,0	
N 1036 M	180	280	46	337	479	2000	2600	10,9	2,1	2,1	255,0	
NJ 1036 M	180	280	46	336	260	2000	2600	10,9	2,1	2,1	205,0	
NU 1036 M	180	280	46	436	479	2000	2600	10,9	2,1	2,1	205,0	
N 236 EM	180	320	52	541,4	797,2	1700	2000	18,17				
N 236 M	180	320	52	516	717	1800	2200	18,8	4	4		218,0
NJ 236 EM	180	320	52	541,4	797,2	1700	2000	18,45				
NJ 236 M	180	320	52	516	717	1800	2200	18,7	4	4	218,0	
NU 236 EM	180	320	52	541,4	797,2	1700	2000	18,16				
NU 236 M	180	320	52	516	717	1800	2200	18,8	4	4	218,0	
NUP 236 M	180	320	52	516	717	1800	2200	18,8	4	4	218,0	
NJ 2236 E	180	320	86	955	1408	1600	1900	31,1	4	4	215,0	
NJ 2236 EM	180	320	86	955	1408	1600	1900	31,1	4	4	215,0	
NJ 2236 M	180	320	86	775	1208	1600	1900	31,1	4	4	218,0	
NU 2236 EM	180	320	86	955	1408	1600	1900	30,5	4	4	215,0	
NU 2236 M	180	320	86	775	1208	1600	1900	31,1	4	4	218,0	
NUP 2236 EM	180	320	86	955	1408	1600	1900	31,1	4	4	215,0	
NUP 2236 M	180	320	86	775	1208	1600	1900	31,1	4	4	218,0	
N 336 M	180	380	75	903	1155	1500	1800	43,4	4	4		328,0
NJ 336 M	180	380	75	903	1155	1500	1800	43,4	4	4	232,0	
NU 336 EM	180	380	75	913	1180	1500	1800	42,5				
NU 336 M	180	380	75	903	1155	1500	1800	43,4	4	4	232,0	
NUP 336 M	180	380	75	903	1155	1500	1800	43,4	4	4	232,0	
NU 2336 EM	180	380	126	1400	2040	1300	1600	73				
NU 2336 M	180	380	126	1380	1995	1300	1600	73,9	4	4	232,0	

Index other bore sizes

BEARING STEEL 100Cr6

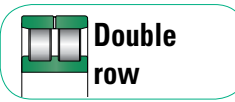
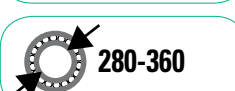

Details part number:

- No suffix: steel cage & standard load ratings
- Suffix **E**: steel cage & increased load ratings
- Suffix **M**: brass cage & standard load ratings
- Suffix **EM**: brass cage & increased load ratings





Deep Groove Ball Bearing	Self-Aligning Ball Bearing	Angular Contact Ball Bearing	
<b>Cylindrical Roller Bearing</b>	Tapered Roller Bearing	Spherical Roller Bearing	
Thrust Ball Bearing	Spherical Roller Thrust Bearing	Accessories Adapter & Withdrawal Sleeve	Technical & Related Information



### 3 5 4 0 0 c

## Single Row Cylindrical Roller Bearing

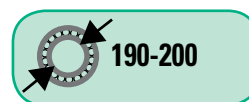
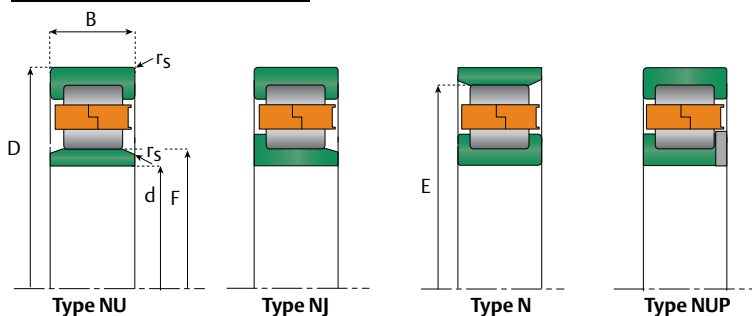

Click here for Technical & Related Information

Part number	Principal dimensions			Basic load ratings		Speed limits		Weight Kg	Radius		Dimensions	
	Bore	Outer	Width	Dynamic	Static	Grease	Oil		rS min	r1s min	F	E
	d	D	B	C	Co	rpm			mm		mm	
NJ 1938 M	190	260	33	251	400	1800	2340	5,5	1	2	209,0	
NJ 1038 M	190	290	46	357	525	1900	2200	11,4	2,1	2,1	215,0	
NU 1038 M	190	290	46	357	525	1900	2200	11,4	2,1	2,1	215,0	
N 238 EM	190	340	55	600,8	846,6	1600	1900	21,74				
N 238 M	190	340	55	567	790	1700	2000	22,5	4	4		299,0
NJ 238 EM	190	340	55	600,8	846,6	1600	1900	21,89				
NJ 238 M	190	340	55	567	790	1700	2000	22,7	4	4		231,0
NU 238 EM	190	340	55	651	878	1700	2000	22,5	4	4		230,0
NU 238 M	190	340	55	567	790	1700	2000	22,7	4	4		231,0
NUP 238 M	190	340	55	567	790	1700	2000	23,1	4	4		231,0
NJ 2238 M	190	340	92	854	1338	1500	1800	37,8	4	4		231,0
NU 2238 EM	190	340	92	1100	1660	1600	1900	39	4	4		231,0
NU 2238 M	190	340	92	854	1338	1500	1800	36,74	4	4		231,0
NJ 338 M	190	400	78	1036	1329	1400	1700	50,5	5	5		243,0
NU 338 EM	190	400	78	1150	1489	1400	1700	50,5	5	5		245,0
NU 338 M	190	400	78	1036	1329	1400	1700	50,5	5	5		243,0
NU 2338 EM	190	400	132	1789	2628	1300	1600	85,5	5	5		245,0
NU 1940 EM	200	280	38	264	405	2200	2800	7,4	2,1	2,1		221,0
NJ 1940 MA	200	280	38	264	405	2200	2800	7,4	2,1	2,1		221
NJ 1040 M	200	310	51	395	590	2000	2600	14,8	2,1	2,1		229,0
NU 1040 M	200	310	51	395	590	2000	2600	14,8	2,1	2,1		229,0
NUP 1040 M	200	310	51	395	590	2000	2600	14,8	2,1	2,1		229,0
N 240 EM	200	360	58	663	996	1500	1800	26,56				
N 240 M	200	360	58	634	892	1600	1900	26,5	4	4		316,0
NJ 240 EM	200	360	58	720	979	1600	1900	26,9	4	4		243,0
NJ 240 M	200	360	58	634	892	1600	1900	26,9	4	4		244,0
NU 240 EM	200	360	58	663	996	1500	1800	26,42				
NU 240 M	200	360	58	634	892	1600	1900	26,5	4	4		244,0
NUP 240 M	200	360	58	634	892	1600	1900	27,5	4	4		244,0
NJ 2240 EM	200	360	98	1220	1860	1400	1700	45,5	4	4		241,0
NU 2240 EM	200	360	98	1220	1860	1400	1700	45,5	4	4		241,0
NU 2240 M	200	360	98	1220	1860	1400	1700	45,5	4	4		
N 340 EM	200	420	80	1250	1678	1300	1600	56,2	5	5		368,0
NJ 340 EM	200	420	80	1250	1648	1300	1600	57,1	5	5		260,0
NJ 340 M	200	420	80	974	1273	1300	1600	57,1	5	5		260,0
NU 340 EM	200	420	80	1250	1648	1300	1600	56	5	5		260,0
NU 340 M	200	420	80	974	1273	1300	1600	57,1	5	5		260,0
NU 2340 EM	200	420	138	1740	2685	1200	1500	97	5	5		
NU 2340 M	200	420	138	1740	2685	1200	1500	97	5	5		

Index other bore sizes

BEARING STEEL 100Cr6

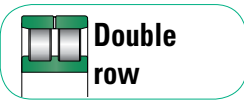
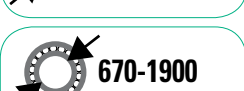
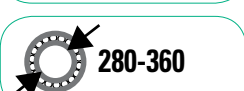

Details part number:

- No suffix: steel cage & standard load ratings
- Suffix E: steel cage & increased load ratings
- Suffix M: brass cage & standard load ratings
- Suffix EM: brass cage & increased load ratings







Deep Groove Ball Bearing	Self-Aligning Ball Bearing	Angular Contact Ball Bearing	
<b>Cylindrical Roller Bearing</b>	Tapered Roller Bearing	Spherical Roller Bearing	
Thrust Ball Bearing	Spherical Roller Thrust Bearing	Accessories Adapter & Withdrawal Sleeve	Technical & Related Information



### 3 5 4 0 0 d

## Single Row Cylindrical Roller Bearing

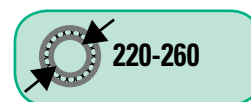
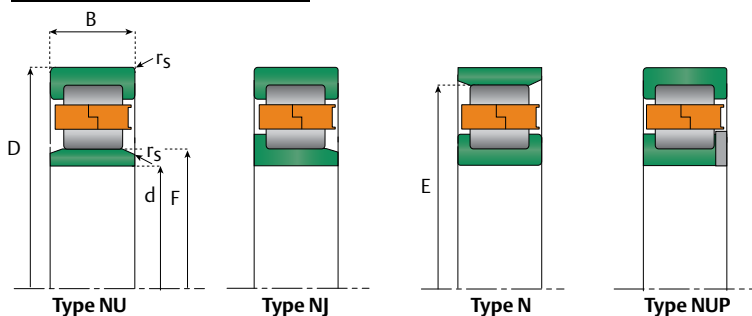

Click here for Technical & Related Information

Part number	Principal dimensions			Basic load ratings		Speed limits		Weight Kg	Radius		Dimensions	
	Bore	Outer	Width	Dynamic	Static	Grease	Oil		rS min	r1s min	F	E
	d	D	B	C	Co	rpm			mm		mm	
NJ 1944 M	220	300	38	336	560	2400	3000	8,3	2,1	2,1	250,0	
NJ 1044 M	220	340	56	650	1047	1300	1600	19,3	3	3	250,0	
NU 1044 M	220	340	56	650	1047	1300	1600	18,5	3	3	250,0	
N 244 EM	220	400	65	725	1110	1500	1800	36,45				
N 244 M	220	400	65	778	1113	1400	1700	38,5	4	4		350,0
NJ 244 EM	220	400	65	725	1110	1500	1800	37,1				
NJ 244 M	220	400	65	778	1113	1400	1700	38,1	4	4	270,0	
NU 244 EM	220	400	65	725	1110	1500	1800	36,4				
NU 244 M	220	400	65	778	1113	1400	1700	38	4	4	270,0	
NUP 244 M	220	400	65	778	1113	1400	1700	40,2	4	4	270,0	
NU 2244 EM	220	400	108	1570	2280	1300	1600	62,5				
NU 2244 M	220	400	108	1370	2310	1400	1700	61,5	4	4	270,0	
NUP 2244 M	220	400	108	1370	2310	1400	1700	61,5	4	4	270,0	
N 344 EM	220	460	88	1130	1160	1200	1500	72,21				
NJ 344 EM	220	460	88	1130	1160	1200	1500	72,72				
NU 344 EM	220	460	88	1130	1160	1200	1500	72,34				
NJ 2344 M	220	460	145	2425	3750	1400	1700	125	5	5		
NU 2344 EM	220	460	145	2425	3750	1400	1700	125	5	5		
NU 2344 M	220	460	145	2425	3750	1400	1700	125	5	5		
NUP 2344 M	220	460	145	2425	3750	1400	1700		5	5		
NU 1948 M	240	320	38	308	540	1900	2400	8,5	2,5	1,8	260,0	
NU 1048 M	240	360	56	520	820	1700	2000	20	3	3	270,0	
NJ 1048 M	240	360	56	512	775	1700	2000	21,1	3	3	270,0	
NU 248 M	240	440	72	1050	1540	1300	1600	46,9	4	4	295,0	
NJ 248 M	240	440	72	1050	1540	1300	1600	49,6	4	4	295,0	
NU 2248 M	240	440	120	1490	2450	1200	1500	84,8	4	4	295,0	
N 348 M	240	500	95	1530	2120	1000	1300	96,3	5	5		430,0
NU 348 M	240	500	95	1530	2120	1000	1300	96,3	5	5	310,0	
NU 2348 M	240	500	155	2190	3360	950	1200	155	5	5	310,0	
NU 1052 M	260	400	65	688	1090	1500	1800	30,2	4	4		347,0
NUP 1052 M	260	400	65	688	1090	1500	1800	37,2	4	4	296,0	
NJ 1052 M	260	400	65	688	1090	1500	1800	36,3	4	4	296,0	
NU 2052 EM	260	400	82	1080	1880	1300	1700	40,1	4	4	294,0	
NU 3052 M	260	400	104	1350	2340	1150	1450	49,5	4	4	290,5	
NU 3152 M	260	440	144	2050	3450	950	1250	98	4	4	298,5	
NU 252 M	260	480	80	1220	1800	1100	1400	67,1	5	5	320,0	
NJ 252 M	260	480	80	1220	1800	1050	1350	68,5	5	5	320,0	
NUP 252 M	260	480	80	1220	1800	1050	1350	70	5	5	320,0	
NU 2252 M	260	480	130	1780	2910	1000	1300	107	5	5	320,0	
N 2252 M	260	480	130	1780	2910	950	1250	105	5	5		420,0
NJ 2252 M	260	480	130	1780	2910	950	1250	108	5	5	320,0	
NU 352 M	260	540	102	1880	2750	850	1050	126	6	6	337,0	
NU 2352 M	260	540	165	3150	4500	850	1050	188	6	6	319,0	

Index other bore sizes

BEARING STEEL 100Cr6

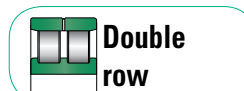

Details part number:

- No suffix: steel cage & standard load ratings
- Suffix **E**: steel cage & increased load ratings
- Suffix **M**: brass cage & standard load ratings
- Suffix **EM**: brass cage & increased load ratings





Deep Groove Ball Bearing	Self-Aligning Ball Bearing	Angular Contact Ball Bearing	
<b>Cylindrical Roller Bearing</b>	Tapered Roller Bearing	Spherical Roller Bearing	
Thrust Ball Bearing	Spherical Roller Thrust Bearing	Accessories Adapter & Withdrawal Sleeve	Technical & Related Information



### 3 5 4 0 0 e

## Single Row Cylindrical Roller Bearing

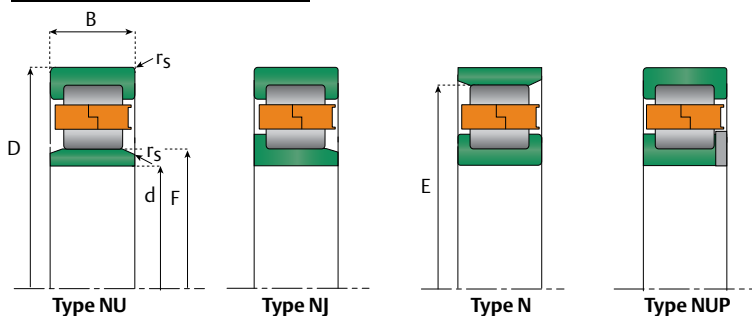

Click here for Technical & Related Information

Part number	Principal dimensions			Basic load ratings		Speed limits		Weight Kg	Radius		Dimensions	
	Bore	Outer	Width	Dynamic	Static	Grease	Oil		rS min	r1S min	F	E
	d	D	B	C	Co	rpm			mm		mm	
NJ 2856 M	280	350	42	363	790	1800	2200	9,15	2	2	299,0	
NU 1956 M	280	380	46	473	865	1700	1900	15,5	2,1	2,1	306,0	
NU 1056 M	280	420	65	704	1140	1400	1700	30,9	4	4	316,0	
NJ 1056 M	280	420	65	704	1140	1400	1700	32,2	4	4	316,0	
NU 2056 M	280	420	82	1190	2170	1050	1300	39,5	4	4	314,0	
NU 3156 M	280	460	146	2250	3900	900	1150	106	5	5	321,0	
NJ 256 M	280	500	80	1100	1750	1150	1450	71,5	5	5	340,0	
NU 256 M	280	500	80	1100	1750	1150	1450	70	5	5	340,0	
NU 2256 EM	280	500	130									
NU 356 M	280	580	108	1880	2660	850	1000	147	6	6	362,0	
NU 2356 M	280	580	175	2560	4250	900	1100	232	6	6	362,0	
NJ 2860 M	300	380	48	450	1000	1370	1650	15,5	2,1	2,1	321,0	
NU 2860 M	300	380	48	450	1000	1370	1650	14,5	2,1	2,1	321,0	
NJ 1060 M	300	460	74	935	1510	1200	1500	45,1	4	4	340,0	
NU 1060 M	300	460	74	935	1510	1200	1500	44,1	4	4	340,0	
NU 2060 M	300	460	95	1470	2800	980	1250	60	4	4	341,0	
NU 3060 M	300	460	118	1470	2700	1200	1500	72,5	4	4	340,0	
NU 260 M	300	540	85	1510	2270	1000	1300	86,9	5	5	364,0	
NU 2260 M	300	540	140	2080	3450	1000	1200	146	5	5	364,0	
NU 360 M	300	620	109	2310	3300	900	1100	166	7,5	7,5	385,0	
NU 2360 M	300	620	185	3860	5850	830	1000	271	7,5	7,5	371,0	
NU 1864 M	320	400	38	365	715	1270	1550	11,3	2,1	1,5	341,0	
NU 2864 M	320	400	48	490	1050	1250	1550	15	2,1	1,5	341,0	
NU 1964 M	320	440	56	638	1130	1100	1400	24,7	3	3	350,0	
NJ 1064 M	320	480	74	957	1580	1100	1400	47,8	4	4	360,0	
NU 1064 M	320	480	74	957	1580	1100	1400	48,2	4	4	360,0	
NUP 1064 M	320	480	74	957	1580	1100	1400	49,1	4	4	360,0	
NU 2064 M	320	480	95	1380	2650	970	1250	63	4	4	360,0	
NU 3064 M	320	480	121	1540	2910	1100	1400	78,1	4	4	360,0	
NU 3164 M	320	540	176	3050	5450	870	1050	176	5	5	368,0	
NU 264 M	320	580	92	1530	2450	960	1200	116	5	5	390,0	
NU 2264	320	580	150	2480	4150	900	1100	181	5	5	390,0	
NJ 2868 M	340	420	48	490	1150	1150	1450	15,5	2,1	2,1	361,0	
NU 1968 M	340	460	56	700	1400	1050	1350	28,3	3	3	370,0	
NU 2968 M	340	460	72	785	1650	1050	1350	36,2	3	3	373,0	
NU 1068 M	340	520	82	1160	1910	1000	1300	65	5	5	385,0	
NU 2268 M	340	620	165	2600	4550	810	950	225	6	6	416,0	
NU 1072 M	360	540	82	1080	2000	980	1280	65,9	5	5	405,0	
NU 2072 M	360	540	106	1890	3560	870	1050	89,5	5	5	405,0	
NU 3072 M	360	540	134	2060	4050	800	1000	112	5	5	405,0	
NU 3172	360	600	192	3520	6500	900	1000	219	5	5	420,0	
NU 2272 M	360	650	170	3150	5400	800	950	262	6	6	437,0	
NU 2372	360	750	224	5390	8650	700	850	480	7,5	7,5	455,0	

Index other bore sizes

BEARING STEEL 100Cr6

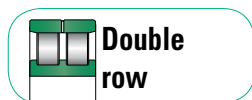
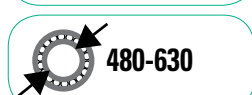
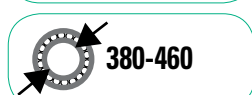

Details part number:

- No suffix: steel cage & standard load ratings
- Suffix E: steel cage & increased load ratings
- Suffix M: brass cage & standard load ratings
- Suffix EM: brass cage & increased load ratings



Deep Groove Ball Bearing	Self-Aligning Ball Bearing	Angular Contact Ball Bearing	
<b>Cylindrical Roller Bearing</b>	Tapered Roller Bearing	Spherical Roller Bearing	
Thrust Ball Bearing	Spherical Roller Thrust Bearing	Accessories Adapter & Withdrawal Sleeve	Technical & Related Information



### 3 5 4 0 0 f

## Single Row Cylindrical Roller Bearing

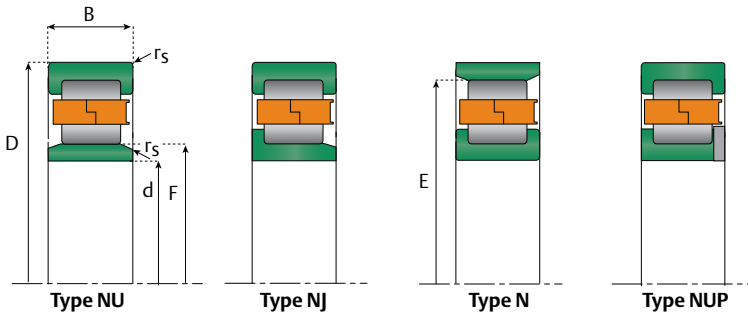

Click here for Technical & Related Information

Part number	Principal dimensions			Basic load ratings		Speed limits		Weight Kg	Radius		Dimensions	
	Bore	Outer	Width	Dynamic	Static	Grease	Oil		rS min	r1s min	F	E
	d	D	B	C	Co	rpm			mm		mm	
NU 1876 M	380	480	46	525	1050	950	1250	23,5	2,1	2,1	406,0	
NUP 1876 M	380	480	46	525	1050	950	1250	24	2,1	2,1	406,0	
NU 1076 M	380	560	82	1220	2090	950	1200	71	5	5	425,0	
NU 2076 EM	380	560	106	1930	3750	800	950	93	5	5	425,0	
NU 3076 EM	380	560	135	2250	4700	800	950	116	5	5	425,0	
NU 2276 EM	380	680	175	3050	5500	730	860	276	6	6	462,0	
NU 1880 M	400	500	46	565	1150	980	1250	21,2	2,1	2,1	423,0	
NU 1980 M	400	540	65	900	1750	900	1150	42	4	4	435,0	
NU 2980 EM	400	540	82	1350	2850	900	1150	57,8	4	4	435,0	
NU 2980 M	400	540	82	1250	2510	900	1150	55,2	4	4	438,0	
NJ 4980 M	400	540	140	5170	2220	1200	1500	84	3	3		
NUP 1080 M	400	600	90	1330	2210	900	1100	93,6	5	5	450,0	
NU 1080 M	400	600	90	1330	2210	900	1100	92,5	5	5	450,0	
NJ 1080 M	400	600	90	1440	2470	900	1100	90,6	5	5	450,0	
NU 2080 EM	400	600	118	2150	4800	750	900	122	5	5	449,0	
NU 3080 M	400	600	148	2330	4550	900	1100	153	5	5	450,0	
NU 2180 M	400	650	145	2920	5190	700	850	197	6	6	460,0	
NU 3180 M	400	650	200	3760	7170	700	850	274	6	6	460,0	
NU 2280 M	400	720	185	4300	7800	800	1050	344	6	6	485,0	
NU 1884 M	420	520	46	605	1270	900	1100	20,7	2,1	2,1	447,0	
NJ 3884 M	420	520	75	900	2250	930	1150	33,3	2,1	2,1	447,0	
NJ 1984 M	420	560	65	1080	1950	930	1150	46	4	4	449,0	
NU 2984 M	420	560	82	1180	2600	930	1150	59,5	4	4	458,0	
NU 1084 M	420	620	90	1440	2490	900	1100	98	5	5	470,0	
NU 2084 EM	420	620	118	2400	4750	770	950	127	5	5	469,0	
NU 3184 EM	420	700	224	4950	8950	650	780	368	6	6	485,0	
NU 2888 EM	440	540	60	790	1900	870	1050	34,5	2,1	2,1	464,0	
NU 1988 M	440	600	74	1010	1980	870	1050	65	4	4	482,0	
NJ 2988 EM	440	600	95	1670	3550	870	1050	83,5	4	4	481,5	
NUP 3988 EM	440	600	118	1940	4250	850	1000	106	4	4	481,5	
NU 1088 M	440	650	94	1570	2430	850	1000	102	6	6	493,0	
NU 2088 EM	440	650	122	2450	5000	670	820	146	6	6	487,0	
N 1188	440	720	122	2850	4300	800	950	207	6	6		648,0
NU 3188	440	720	226	5230	9800	600	750	374	6	6	508,0	
N 1892 M	460	580	56	795	1720	800	950	37,2	3	3		553,0
NJ 2892 EM	460	580	72	1030	2350	860	1050	48,7	3	3	489,0	
NJ 2992	460	620	95	1640	3500	800	950	83,4	4	4	502,0	
NUP 2992	460	620	95	1670	1600	800	950	85	4	4	502,0	
NU 2992	460	620	95	1670	1600	800	950	98,3	4	4	502,0	
NU 1092 M	460	680	100	1690	2630	800	950	111	6	6	516,0	
NU 2092 EM	460	680	128	2700	5450	650	800	166	6	6	513,0	
NU 3092 M	460	680	163	2970	6150	650	790	211	6	6	516,0	
NU 3092 EM	460	680	163	3300	6340	650	790	211	6	6	499,0	
NU 3192	460	760	240	5450	10400	400	480	467	7,5	7,5	531,0	
NU 3192 M	460	760	240	5450	10400	400	480	481	7,5	7,5	531,0	
NU 2292 M	460	830	212	4850	8000	580	670	515	7,5	7,5	554,0	

Index other bore sizes

BEARING STEEL 100Cr6

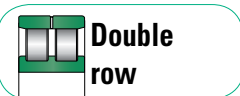

Details part number:

- No suffix: steel cage & standard load ratings
- Suffix **E**: steel cage & increased load ratings
- Suffix **M**: brass cage & standard load ratings
- Suffix **EM**: brass cage & increased load ratings





Deep Groove Ball Bearing	Self-Aligning Ball Bearing	Angular Contact Ball Bearing	
<b>Cylindrical Roller Bearing</b>	Tapered Roller Bearing	Spherical Roller Bearing	
Thrust Ball Bearing	Spherical Roller Thrust Bearing	Accessories Adapter & Withdrawal Sleeve	Technical & Related Information



# 3 5 4 0 0 h

## Single Row Cylindrical Roller Bearing

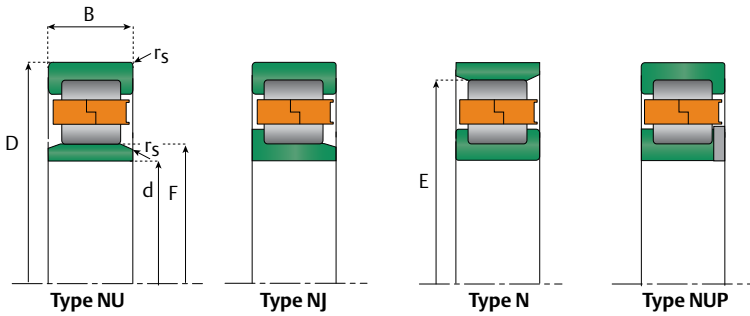

Click here for Technical & Related Information

Part number	Principal dimensions			Basic load ratings		Speed limits		Weight Kg	Radius		Dimensions	
	Bore	Outer	Width	Dynamic	Static	Grease	Oil		rS min	r1S min	F	E
	d	D	B	C	Co	rpm			mm		mm	
	mm			kN		1 min <sup>-1</sup>						
NU 1896 M	480	600	56	750	1620	840	950	37,5	3	3	511,0	
NJ 2896 EM	480	600	72	1050	2400	840	950	46,5	3	3	509,5	
NU 1096 M	480	700	100	1600	2970	720	860	128	6	6	536,0	
NU 2096 M	480	700	128	2600	5250	600	720	176	6	6	536,0	
NU 3196 EM	480	790	248	5650	10700	500	600	495	7,5	7,5	547,0	
NU 28/500 EM	500	620	72	1130	2670	780	940	48,5	3	3	530,0	
NU 19/500 EM	500	670	78	1160	2350	720	880	80	5	5	544,0	
NU 29/500	500	670	100	1940	4300	750	900	101	5	5	543,0	
N 39/500 EM	500	670	128	2250	5150	670	840	128	5	5		633,0
NJ 10/500	500	720	100	1680	3050	720	880	136	6	6	556,0	
NU 60/500 M	500	720	100	2270	4270	750	900	136,9	6	6	555,0	
NU 20/500 EM	500	720	128	2850	5900	620	720	175	6	6	553,0	
NU 30/500	500	720	167	3210	6970	620	720	232	6	6	556,0	
NU 31/500	500	830	264	6250	12200	480	580	602	7,5	7,5	581,0	
NU 12/500 M	500	920	185	5050	8450	540	650	585	7,5	7,5	603,1	
NJ 19/530 EM	530	710	82	1500	2980	680	830	94,5	5	5	573,0	
NUP 29/530	530	710	106	1990	4550	400	500	125	5	5	580,0	
NU 10/530 M	530	780	112	2200	4050	650	780	187	6	6	593,0	
NU 20/530 EM	530	780	145	3650	7360	550	650	252	6	6	591,0	
NU 31/530 EM	530	870	272	7250	14500	460	550	663	7,5	7,5	612,0	
NJ 18/560 M	560	680	56	810	1830	670	820	42,5	3	3	591,0	
NU 19/560 EM	560	750	85	1630	3200	650	780	108	5	5	608,0	
NJ 29/560	560	750	112	2420	5450	650	780	153	5	5	607,0	
N 29/560	560	750	112	2490	5600	650	780	138	5	5		703,0
NU 10/560 M	560	820	115	2250	4200	620	720	215	6	6	625,0	
NU 20/560 EM	560	820	150	3650	7600	500	600	289	6	6	626,0	
NU 12/560 M	560	1030	206	6850	11000	460	550	809	9,5	9,5	668,0	
NU 18/600 EM	600	730	60	860	2000	650	780	49,3	3	3	632,0	
NU 28/600 EM	600	730	78	1250	3350	620	730	68,5	3	3	632,0	
NU 19/600 EM	600	800	90	1900	3800	620	750	128	5	5	649,0	
NUP 19/600 M	600	800	90	1900	3800	620	750	135	5	5	649,0	
NUP 19/600 M	600	800	90	1900	3800	630	750	140	5	5	649	
NUP 29/600 M	600	800	118	2920	6550	630	750	145	5	5	649	
NU 10/600	600	870	118	2840	5250	590	680	234	6	6	667,0	
NU 20/600 EM	600	870	155	4180	8000	500	600	320	6	6	661,0	
NJ 18/630 EM	630	780	69	1050	2500	630	750	74,2	4	4	667,0	
N 28/630 M	630	780	88	1800	4500	630	750	95,6	4	4		744,0
NU 28/630 M	630	780	88	1800	4500	630	750	96	4	4	668,0	
N 38/630 M	630	780	112	2150	5750	550	650	118	4	4		745,0
NU 19/630 M	630	850	100	1980	4000	600	700	158	6	6	688,0	
NU 19/630 EM	630	850	100	2150	4250	600	700	160	6	6	683,0	
NU 29/630 EM	630	850	128	3250	7250	580	680	214	6	6	683,0	
NJ 29/630 EM	630	850	128	3250	7250	580	680	222	6	6	683,0	
NU 10/630 EM	630	920	128	3400	6250	450	530	284	7,5	7,5	702,0	
NUP 10/630 EM	630	920	128	3400	6250	450	530	284	7,5	7,5	702,0	
NU 20/630 EM	630	920	170	4700	9500	480	560	395	7,5	7,5	699,0	
NU 30/630	630	920	212	6450	14500	450	530	485	7,5	7,5	699,0	

Index other bore sizes  
BEARING STEEL 100Cr6

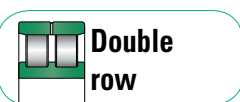

Details part number:

- No suffix: steel cage & standard load ratings
- Suffix **E**: steel cage & increased load ratings
- Suffix **M**: brass cage & standard load ratings
- Suffix **EM**: brass cage & increased load ratings



Deep Groove Ball Bearing	Self-Aligning Ball Bearing	Angular Contact Ball Bearing	
<b>Cylindrical Roller Bearing</b>	Tapered Roller Bearing	Spherical Roller Bearing	
Thrust Ball Bearing	Spherical Roller Thrust Bearing	Accessories Adapter & Withdrawal Sleeve	Technical & Related Information



# 3 5 4 0 0 k

## Single Row Cylindrical Roller Bearing

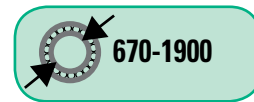
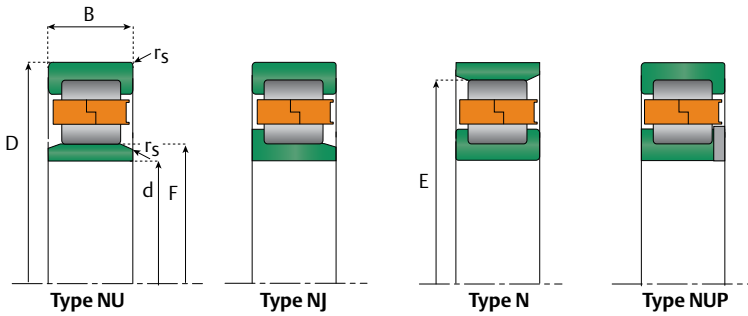

Click here for Technical & Related Information

Part number	Principal dimensions			Basic load ratings		Speed limits		Weight Kg	Radius		Dimensions	
	Bore	Outer	Width	Dynamic	Static	Grease	Oil		rS min	r1S min	F	E
	d	D	B	C	Co	rpm			mm		mm	
	mm			kN		1 min <sup>-1</sup>						
NJ 18/670	670	820	69	1230	2800	550	650	83,8	4	4	708,0	
NUP 19/670	670	900	103	2420	4900	530	630	193	6	6	731,0	
NU 19/670	670	900	103	2420	4900	530	630	193	6	6	731,0	
NU 10/670	670	980	136	3700	6800	430	500	344	7,5	7,5	747,0	
N 30/670	670	980	230	6930	15000	430	500	594	7,5	7,5		914,0
NU 30/670 M	670	980	230	6500	14500	430	500	596	7,5	7,5	744,0	
NU 6/700	700	930	160	3520	8500	500	600	306	6	6	760,0	
NUP 6/700	700	930	160	3520	8500	500	600	316	6	6	760,0	
N 28/710 EM	710	870	95	1880	4950	480	560	128	4	4		831,0
NU 19/710	710	950	106	2590	5500	480	560	210	6	6	770,0	
NU 29/710 EM	710	950	140	3650	8250	480	560	294	6	6	766,0	
NU 10/710 EM	710	1030	140	4550	8400	420	490	420	7,5	7,5	778,0	
NU 20/710 EM	710	1030	185	5800	12000	420	490	535	7,5	7,5	787,0	
NU 18/750 M	750	920	78	1450	3500	480	590	105	5	5	794,0	
N 28/750	750	920	100	2160	5500	480	590	145	5	5		880,0
NU 10/750 EM	750	1090	150	4500	8500	350	415	492	7,5	7,5	830,0	
NU 20/750 EM	750	1090	195	6700	14500	350	415	634	7,5	7,5	832,0	
NJ 18/800 EM	800	980	82	1700	4200	430	510	144	5	5	846,0	
NU 10/800 M	800	1150	155	5400	10500	320	380	565	7,5	7,5	883,0	
NU 20/800 EM	800	1150	200	6900	14500	320	380	710	7,5	7,5	882,0	
N 6/820	820	990	72	1180	2960	450	530	128	5	5		943,0
NU 28/850 M	850	1030	106	2050	5900	410	480	192	5	5	902,0	
NU 19/850 EM	850	1120	118	3050	6900	390	460	325	6	6	919,0	
NJ 19/850	850	1120	118	2930	7000	390	460	326	6	6	919,0	
N 29/850 EM	850	1120	155	4500	11300	390	460	428	6	6		1059,0
NU 18/900 M	900	1090	85	1900	4850	370	440	172	5	5	949,0	
NU 28/900 M	900	1090	112	2650	7150	370	440	234	5	5	949,0	
NU 19/900 EM	900	1180	122	4050	8700	350	420	378	6	6	966,5	
NU 29/900 EM	900	1180	165	5750	13500	350	420	565	6	6	969,0	
NU 29/950	950	1250	175	5560	13000	340	400	596	7,5	7,5	1024,0	
NUP 29/950	950	1250	175	5670	13400	140	170	616	7,5	7,5	1024,0	
NU 18/1000 M	1000	1220	100	2650	6550	350	420	264	6	6	1053,0	
NJ 28/1000 EM	1000	1220	128	3600	9500	350	420	345	6	6	1053,0	
N 28/1060 M	1060	1280	128	3550	10500	310	370	355	6	6		1225,0
NU 29/1060 EM	1060	1400	195	7200	17000	290	350	875	7,5	7,5	1146,0	
NU 39/1060 EM	1060	1400	250	9000	23500	250	310	1060	7,5	7,5	1146,0	
N 30/1060	1060	1500	325	12500	32500	230	290	1880	9,5	9,5		1390,0
NJ 18/1120 EM	1120	1360	106	3350	8600	270	330	330	6	6	1182,0	
NJ 18/1180 EM	1180	1420	106	2950	7750	250	320	354	6	6	1242,0	
NU 29/1180 M	1180	1540	206	8950	21500	180	220	1100	7,5	7,5	1258,0	
NU 29/1180 EM	1180	1540	206	8950	21500	180	220	1100	7,5	7,5	1258,0	
N 39/1180 M	1180	1540	272	11000	28500	190	250	1350	7,5	7,5		1466,0
N 20/1250 M	1250	1750	290	12500	29500	165	190	2310	9,5	9,5		1635,0
NU 18/1320 M	1320	1600	122	3650	9500	190	250	525	6	6	1395,0	
NU 19/1320	1320	1720	175	7920	19500	190	240	1110	7,5	7,5	1425,0	
N 39/1320 M	1320	1720	300	12600	32500	175	210	1890	7,5	7,5		1640,0
N 28/1400 EM	1400	1700	175	6300	1750	175	210	858	7,5	7,5		1637,0
NU 18/1700 EM	1700	2060	160	6950	18500	125	155	1156	7,5	7,5	1784,0	
N 18/1900	1900	2300	175	8150	23700	90	115	1480	9,5	9,5		2204,0

Index other bore sizes

BEARING STEEL 100Cr6

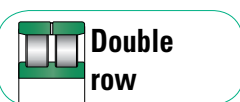

Details part number:

- No suffix: steel cage & standard load ratings
- Suffix **E**: steel cage & increased load ratings
- Suffix **M**: brass cage & standard load ratings
- Suffix **EM**: brass cage & increased load ratings





Deep Groove Ball Bearing	Self-Aligning Ball Bearing	Angular Contact Ball Bearing	
<b>Cylindrical Roller Bearing</b>	Tapered Roller Bearing	Spherical Roller Bearing	
Thrust Ball Bearing	Spherical Roller Thrust Bearing	Accessories Adapter & Withdrawal Sleeve	Technical & Related Information



# 3 5 4 1 0 a

## Double Row Cylindrical Roller Bearing



Click here for Technical & Related Information

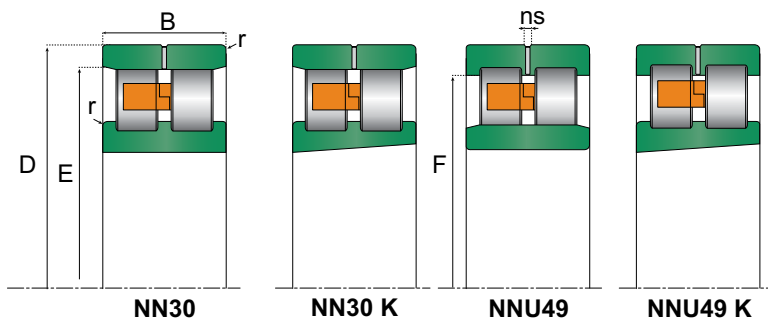

NN30

NN30 K

NNU49

NNU49 K

Part number	Principal dimensions			Basic load ratings		Speed limits		Weight	Radius		Dimensions	
	Bore	Outer	Width	Dynamic	Static	Grease	Oil		rS min	r1s min	F	E
	d	D	B	Cr	Cor	rpm		mm		mm		
NN 3006 K M NA	30	55	19	29,0	38	11000	14000	0,192	1,0	4,5		48,5
NN 3007 K M NA	35	62	20	36,5	47	10000	12000	0,246	1,0	4,5		55,0
NN 3008 K M NA	40	68	21	42,5	58	9000	11000	0,298	1,0	4,5		61,0
NN 3009 K M NA	45	75	23	48,5	70	8000	9500	0,382	1,0	4,5		67,5
NN 3010 K M NA	50	80	23	51,5	80	7500	9000	0,415	1,0	4,5		72,5
NN 3011 K M NA	55	90	26	69,0	100	6700	8000	0,618	1,1	4,5		81,0
NN 3012 K M NA	60	95	26	72,0	110	6300	7500	0,664	1,1	4,5		86,1
NN 3013 K M NA	65	100	26	74,0	118	6000	7000	0,705	1,1	4,5		91,0
NN 3014 K M NA	70	110	30	96,0	151	5300	6300	1,020	1,1	6,5		100,0
NN 3015 K M NA	75	115	30	96,0	153	5000	6000	1,080	1,1	6,5		105,0
NN 3016 K M NA	80	125	34	118,0	184	4800	5600	1,500	1,1	6,5		113,0
NN 3017 K M NA	85	130	34	122,0	200	4500	5300	1,580	1,1	6,5		118,0
NN 3018 K M NA	90	140	37	141,0	224	4300	5000	2,010	1,5	6,5		127,0
NN 3019 K M NA	95	145	37	146,0	236	4000	4800	2,100	1,5	6,5		132,0
NNU 4920 M NA	100	140	40	125,0	244	4000	4800	1,790	1,1	6,5	113,0	
NNU 4920 K M NA	100	140	40	125,0	244	4000	4800	1,800	2,0		113,0	
NN 3020 K M NA	100	150	37	152,0	264	3800	4500	2,210	1,5	6,5		137,0
NNU 4921 K M NA	105	145	40	118,0	231	3800	4500	2,000	1,1		118,0	
NN 3021 K M NA	105	160	41	192,0	310	3600	4300	2,810	2,0	6,5		146,0
NNU 4922 K M NA	110	150	40	129,0	264	3800	4500	1,910	1,1	6,5	123,0	
NN 3022 K M NA	110	170	45	226,0	365	3400	4000	3,560	2,0	6,5		155,0
NNU 4924 K M NA	120	165	45	170,0	328	3400	4000	2,660	1,1	6,5	134,0	
NN 3024 K M NA	120	180	46	235,0	405	3200	3800	3,870	2,0	6,5		165,0
NNU 4926 K M NA	130	180	50	193,0	371	3200	3800	3,600	1,5	6,5	146,0	
NN 3026 K M NA	130	200	52	294,0	510	3000	3600	5,760	2,0	9,5		182,0
NNU 4928 K M NA	140	190	50	189,0	395	3000	3600	3,790	1,5	6,5	156,0	
NN 3028 K M NA	140	210	53	305,0	520	2800	3400	6,210	2,0	9,5		192,0
NNU 4930 K M NA	150	210	60	326,0	645	2600	3200	6,460	2,0		168,5	
NN 3030 K M NA	150	225	56	339,0	600	2600	3000	7,500	2,1	9,5		206,0
NNU 4932 K M NA	160	220	60	322,0	652	2600	3000	6,380	2,0		178,0	
NNU 4934 K M NA	170	230	60	335,0	718	2400	3000	7,210	2,0	6,5	188,5	
NN 3034 K M NA	170	260	67	458,0	810	2200	2600	12,400	2,1	9,5		236,0
NN 3036 K M NA	180	280	74	576,0	1080	2000	2600	16,300	2,1	12,2		255,0

Index other bore sizes

BEARING STEEL 100Cr6





Deep Groove Ball Bearing	Self-Aligning Ball Bearing	Angular Contact Ball Bearing	
<b>Cylindrical Roller Bearing</b>	Tapered Roller Bearing	Spherical Roller Bearing	
Thrust Ball Bearing	Spherical Roller Thrust Bearing	Accessories Adapter & Withdrawal Sleeve	Technical & Related Information



Click here for  
Technical & Related  
Information

### 3 5 4 1 0 b

## Double Row Cylindrical Roller Bearing

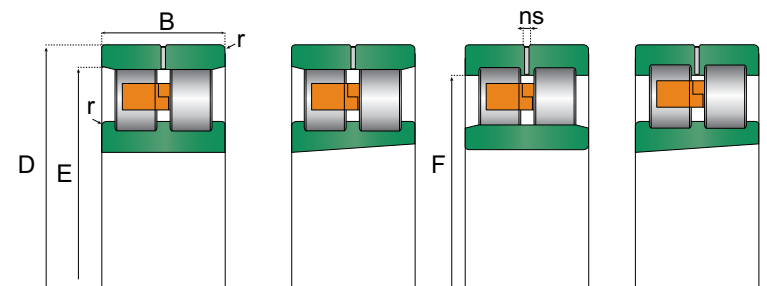
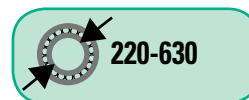

NN30      NN30 K      NNU49      NNU49 K

Part number	Principal dimensions			Basic load ratings		Speed limits		Weight	Radius		Dimensions	
	Bore	Outer	Width	Dynamic	Static	Grease	Oil		rS min	r1s min	F	E
	d	D	B	Cr	Cor	rpm			mm		mm	
	mm			kN		1 min <sup>-1</sup>		Kg				
NUU 4944 M NA	220	300	82	533,7	1330	1800	2100	16,600	2,1		243,0	
NUU 4952 M NA	260	360	100	852,8	2100	1600	1900	31,700	2,1		292,0	
NN 3048 K	240	360	92	885,0	1690	1700	2000	32,700	3,0			330,0
NN 3056 K M NA	280	420	106	1110	1985	1400	1700	49,5	4,0	15,0		384
NUU 4960 K M NA	300	420	118	1075	2410	1300	1600	50,5	3,0		339	
NUU 4964 K M NA	320	440	118	1115	2581	1300	1500	54,5	3,0		359	
NUU 4164 M	320	540	218	3300	6200	700	1000	200,0	5,0		375	
NUU 4972 M	360	480	118	1120	2800	1120	1400	55,0	3,0	3,0	399	
NUU 4172 M	360	600	243	3900	8500	900	1100	275	3,0			
NUU 4976 K M NA	380	520	140	1485	3760	1100	1300	91,0	4,0		426	
NN 3076 K M NA	380	560	135	1640	3650	1000	1200	111,0	5,0	16,7		513
NNCL 4980	400	540	140	2340	5900	700	310	96,5	4,0	7,0		
NUU 4984 M	420	560	140	1550	4081	1000	1000	96,0	4,0	16,7	466	
NUU 4188 M	440	720	280	4470	11500	600	700	452,0	6,0		511	
NUU 4992 K M NA	460	620	160	2135	5543	900	1100	143,0	4,0		510	
NUU 49/500 K M NA	500	670	170	2715	6920	800	1000	178,0	5,0		552	
NUU 41/500 M	500	830	325	7400	14500	580	700	499,0	7,5		582	
NUU 49/530 K M NA	530	710	180	3140	8845	800	950	218,0	5,0		588	
NUU 49/630 K M NA	630	850	218	3835	10716	670	800	368,0	6,0		704	
NUU 41/630 M NA	630	1030	400	10263	22104	340	420	1304,0	7,5		734	

[Index other bore sizes](#)

**BEARING STEEL 100Cr6**





Deep Groove Ball Bearing	Self-Aligning Ball Bearing	Angular Contact Ball Bearing	
<b>Cylindrical Roller Bearing</b>	Tapered Roller Bearing	Spherical Roller Bearing	
Thrust Ball Bearing	Spherical Roller Thrust Bearing	Accessories Adapter & Withdrawal Sleeve	Technical & Related Information



Click here for Technical & Related Information

### 3 5 5 0 0 a

## Cylindrical Roller Bearing - Full Complement - Single Row

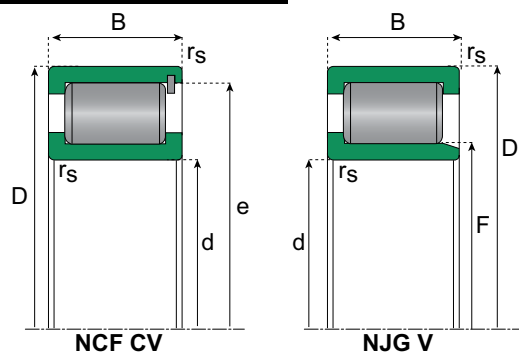
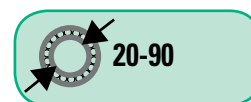

Part number	Principal dimensions			Basic load ratings		Speed limits		Weight Kg	Radius rs min mm	Dimensions	
	Bore d	Outer D	Width B	Dynamic C	Static Co	Grease rpm	Oil rpm			E & F	S*
	mm			kN		1 min <sup>-1</sup>				mm	
NCF 3004 CV	20	42	16	27,5	26,5	1000	9000	0,11	0,6		1,5
NCF 2204 CV	20	47	18	41	37,5	9500	8000	0,16	1		1
NCF 3005 CV	25	47	16	31,5	32,5	9000	7000	0,12	0,6		1,5
NCF 2205 CV	25	52	18	46	45	8500	6500	0,18	1		1
NJG 2305 CV	25	62	24	65	60	7500	5500	0,37	1,1		2
NCF 3006 CV	30	55	19	40,5	43	7500	6500	0,2	1		2
NCF 2206 CV	30	62	20	63	65	7000	5500	0,3	1		1
NJG 2306 CV	30	72	27	89	88	6500	4900	0,56	1,1		2
NCF 3007 CV	35	62	20	49,5	55	6500	6000	0,26	1		2
NCF 2207 CV	35	72	23	79	79	6000	5000	0,44	1,1		1
NJG 2307 CV	35	80	31	113	112	5500	4300	0,74	1,5	44,68	2
NCF 3008 CV	40	68	21	59	68	6000	5000	0,31	1		2
NCF 2208 CV	40	80	23	87	83	5500	4400	0,55	1,1		1
NJG 2308 CV	40	90	33	152	156	5000	3600	1,01	1,5		2
NCF 3009 CV	45	75	23	63	76	5500	5000	0,4	1		2
NCF 2209 CV	45	85	23	90	99	5000	4200	0,59	1,1		1
NJG 2309 CV	45	100	36	162	172	4500	3700	1,37	1,5		3
NCF 3010 CV	50	80	23	79	96	5000	4500	0,43	1		2
NCF 2210 CV	50	90	23	97	113	4600	3600	0,64	1,1		1
NJG 2310 CV	50	110	40	208	219	4100	3400	1,81	2		3
NCF 3011 CV	55	90	26	107	138	4500	3800	0,64	1,1		2
NCF 2211 CV	55	100	25	125	150	4200	3300	0,87	1,5		1,5
NJG 2311 CV	55	120	43	242	255	3700	3100	2,28	3		3
NCF 2912 CV	60	85	16	57	78	4500	3500	0,29	1		1
NCF 3012 CV	60	95	26	110	145	4200	3600	0,69	1,1		2
NCF 2212 CV	60	110	28	152	180	3800	3100	1,18	1,5		1,5
NJG 2312 CV	60	130	46	260	280	3400	2900	2,88	2,1		3
NCF 2913 CV	65	90	16	60	86	4200	3100	0,31	1		1
NCF 3013 CV	65	100	26	116	159	3900	3300	0,73	1,1		2
NCF 2213 CV	65	120	31	178	214	3500	3000	1,57	1,5		1,5
NJG 2313 CV	65	140	48	315	355	3200	2500	3,52	2,1		3,5
NCF 2914 CV	70	100	19	79	114	3800	3100	0,49	1		1
NCF 3014 CV	70	110	30	137	176	3600	3400	1,02	1,1		3
NCF 2214 CV	70	125	31	184	227	3300	2800	1,66	1,5		1,5
NJG 2314 CV	70	150	51	345	390	2900	2400	4,33	2,1		3,5
NCF 2915 CV	75	105	19	81	121	3600	2900	0,52	1		1
NCF 3015 CV	75	115	30	145	194	3400	3000	1,06	1,1		3
NCF 2215 CV	75	130	31	190	241	3200	2700	1,75	1,5		1,5
NCF 2916 CV	80	110	19	84	129	3400	2700	0,55	1		1
NCF 3016 CV	80	125	34	173	225	3200	3000	1,43	1,1		4
NCF 2216 CV	80	140	33	226	285	2900	2500	2,15	2		1,5
NJG 2316 CV	80	170	58	480	560	2600	1900	6,32	2,1		3,5
NCF 2917 CV	85	120	22	105	162	3200	2700	0,81	1,1		1
NCF 3017 CV	85	130	34	178	237	3000	2800	1,51	1,1		4
NCF 2217 CV	85	150	36	255	325	2800	2400	2,74	2		1,5
NJG 2317 CV	85	180	60	510	620	2400	1700	7,34	3		4
NCF 2918 CV	90	125	22	109	172	3000	2500	0,84	1,1		1
NCF 3018 CV	90	140	37	208	280	2800	2700	1,97	1,5	130,65	4
NCF 2218 CV	90	160	40	290	370	2600	2100	3,48	2		2,5
NJG 2318 CV	90	190	64	560	660	2300	1800	8,83	3		4

Index other bore sizes

BEARING STEEL 100Cr6

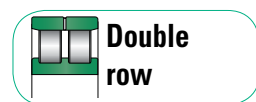

Alternative part number:

Equivalent prefix for **NCF**:  
SL 18  
Equivalent prefix for **NJG**:  
SL 19

Details part number:

- Suffixes **C**: modified internal design
- Suffixes **V**: version without cage (full complement)

S\*: indicates maximum axial displacement from the inner ring.





Deep Groove Ball Bearing	Self-Aligning Ball Bearing	Angular Contact Ball Bearing	
<b>Cylindrical Roller Bearing</b>	Tapered Roller Bearing	Spherical Roller Bearing	
Thrust Ball Bearing	Spherical Roller Thrust Bearing	Accessories Adapter & Withdrawal Sleeve	Technical & Related Information



Click here for  
Technical & Related  
Information

### 3 5 5 0 0 b

## Cylindrical Roller Bearing - Full Complement - Single Row

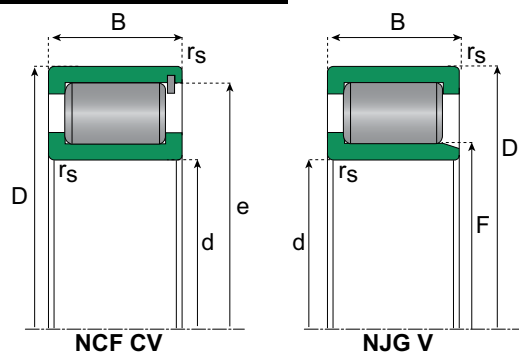

Part number	Principal dimensions			Basic load ratings		Speed limits		Weight Kg	Radius rs min mm	Dimensions	
	Bore d	Outer D	Width B	Dynamic C	Static Co	Grease rpm	Oil rpm			E & F	S*
	mm			kN		1 min <sup>-1</sup>				mm	
NCF 2919 CV	95	130	22	118	179	2900	2400	0,86	1,1		1
NCF 2219 CV	95	170	43	340	435	2400	2000	4,17	2,1		2,5
NJG 2319 CV	95	200	67	580	720	2200	1700	10,2	3		4
NCF 2920 CV	100	140	24	136	206	2700	2300	1,14	1,1		1,5
NCF 3020 V	100	150	37	240	375	950	2000	2,32	1,5	139	
NCF 3020 CV	100	150	37	219	310	2600	2400	2,15	1,5		4
NCF 2220 CV	100	180	46	395	520	2300	1800	5,13	2,1		2,5
NJG 2320 CV	100	215	73	710	860	2100	1500	13	3		4
NCF 2922 CV	110	150	24	140	220	2500	2100	1,23	1,1		1,5
NCF 3022 CV	110	170	45	285	395	2300	2200	3,5	2		5,5
NCF 2222 CV	110	200	53	455	590	2100	1800	7,24	2,1		4
NJG 2322 CV	110	240	80	850	980	1900	1300	17	3		5
NCF 2924 CV	120	165	27	180	295	2300	1900	1,73	1,1		1,5
NCF 3024 V	120	180	46	340	550	800	1700	3,96	2	167,5	
NCF 3024 CV	120	180	46	300	435	2200	1900	3,8	2		5,5
NCF 2224 CV	120	215	58	540	730	1900	1500	9,08	2,1		4
NJG 2324 CV	120	260	86	1000	1240	1700	1200	22,3	3		5
NCF 2926 CV	130	180	30	214	355	2100	1800	2,33	1,5		2
NCF 3026 V	130	200	52	420	690	700	1500	5,44	2	185,5	
NCF 3026 CV	130	200	52	435	620	2000	1700	5,65	2		5,5
NCF 2226 CV	130	230	64	630	860	1800	1400	11,25	3		5
NCF 2928 CV	140	190	30	232	385	2000	1600	2,42	1,5		2
NCF 3028 V	140	210	53	460	750	670	1400	6,3	2	196,5	
NCF 3028 CV	140	210	53	455	680	1900	1500	6,04	2		5,5
NCF 2228 CV	140	250	68	720	1020	1700	1300	14,47	3		5
NCF 2930 V	150	210	36	280	500	670	1400	3,86	2	195,5	
NCF 2930 CV	150	210	36	305	490	1800	1500	3,77	2		2,5
NCF 3030 V	150	225	56	500	850	630	1300	7,78	2,1	208	
NCF 3030 CV	150	225	56	480	710	1700	1500	7,33	2,1		7
NCF 2230 CV	150	270	73	830	1180	1500	1200	18,43	3		6
NCF 2932 V	160	220	36	295	540	630	1300	4,11	2	240,7	
NCF 2932 CV	160	220	36	320	520	1700	1300	4	2		2,5
NCF 3032 V	160	240	60	580	950	600	1200	9,1	2,1	225,1	
NCF 3032 CV	160	240	60	550	820	1600	1300	8,8	2,1		7
NCF 2934 V	170	230	36	300	570	600	1200	4,28	2	216	
NCF 2934 CV	170	230	36	330	560	1600	1200	4,3	2		2,5
NCF 3034 V	170	260	67	730	1180	560	1100	12,5	2,1	243,2	
NCF 3034 CV	170	260	67	710	1070	1500	1100	12,2	2,1		7
NCF 2234 CV	170	310	86	1150	1680	1400	900	28,65	3		7
NCF 2936 V	180	250	42	410	690	560	1100	6,15	2	231	
NCF 2936 CV	180	250	42	410	690	1500	1200	6,2	2		2,5
NCF 3036 V	180	280	74	820	1370	560	1100	16,7	2,1	260	
NCF 3036 CV	180	280	74	820	1260	1400	1000	16,1	2,1		7
NCF 2236 CV	180	320	86	1190	1780	1300	850	29,8	4		7
NCF 2938 V	190	260	42	420	750	560	1100	6,43	2	242,5	
NCF 2938 CV	190	260	42	455	790	1400	1100	6,5	2		2,5
NCF 3038 V	190	290	75	850	1400	530	1000	17,7	2,1	267,5	
NCF 3038 CV	190	290	75	840	1320	1400	1000	17	2,1		9
NCF 2238 CV	190	340	92	1310	1920	1200	800	35,65	4		19

S\*: indicates maximum axial displacement from the inner ring.

Index other bore sizes

BEARING STEEL 100Cr6

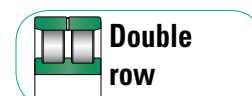
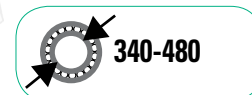

Alternative part number:

Equivalent prefix for **NCF**:  
SL 18  
Equivalent prefix for **NJG**:  
SL 19

Details part number:

- Suffixes **C**:  
modified internal design
- Suffixes **V**:  
version without cage (full complement)



Deep Groove Ball Bearing	Self-Aligning Ball Bearing	Angular Contact Ball Bearing	
<b>Cylindrical Roller Bearing</b>	Tapered Roller Bearing	Spherical Roller Bearing	
Thrust Ball Bearing	Spherical Roller Thrust Bearing	Accessories Adapter & Withdrawal Sleeve	Technical & Related Information



Click here for Technical & Related Information

### 3 5 5 0 0 C

## Cylindrical Roller Bearing - Full Complement - Single Row

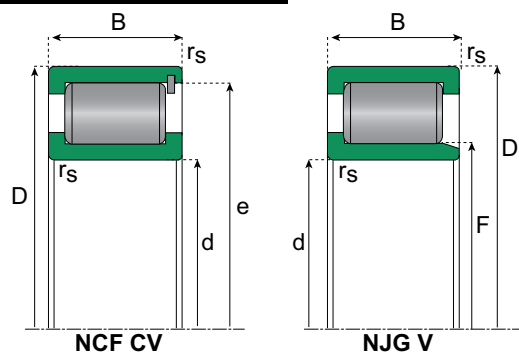
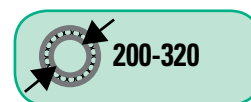

Part number	Principal dimensions			Basic load ratings		Speed limits		Weight Kg	Radius rs min mm	Dimensions	
	Bore d	Outer D	Width B	Dynamic C	Static Co	Grease rpm	Oil rpm			E & F	S*
	mm			kN		1 min <sup>-1</sup>				mm	
NCF 1840 V	200	250	24	180	330	560	1100	2,57	1,5	237,8	
NCF 1840 CV	200	250	24	183	330	1400	1200	2,57	1,5		2
NCF 2940 V	200	280	48	500	1000	530	1000	9,01	2,1	261,2	
NCF 2940 CV	200	280	48	550	960	1400	1000	9,1	2,1		3
NCF 3040 V	200	310	82	990	1700	500	950	22,6	2,1	286	
NCF 3040 CV	200	310	82	960	1530	1300	900	21,8	2,1		9
NCF 2240 CV	200	360	98	1420	2040	1200	800	43,12	4		9
NCF 1844 V	220	270	24	190	360	530	1000	2,8	1,5	257,5	
NCF 1844 CV	220	270	24	192	365	1300	1000	2,8	1,5		2
NCF 2944 V	220	300	48	500	1000	480	900	9,6	2,1	282	
NCF 2944 CV	220	300	48	580	1050	1200	850	9,9	2,1		3
NCF 3044 V	220	340	90	1190	2040	450	850	30,2	3	312	
NCF 3044 CV	220	340	90	1160	1840	1200	850	28,4	3		9
NCF 1848 V	240	300	28	260	500	480	900	4,4	2	284	
NCF 1848 CV	240	300	28	224	435	1200	950	4,4	2		3
NCF 2948 V	240	320	48	580	1140	450	850	10,3	2,1	303	
NCF 2948 CV	240	320	48	610	1140	1200	750	10,6	2,1		3
NCF 3048 V	240	360	92	1150	2240	430	800	32,7	3	335,6	
NCF 3048 CV	240	360	92	1220	2010	1100	750	30,9	3		11
NCF 1852 V	260	320	28	270	550	430	800	4,71	2	307	
NCF 1852 CV	260	320	28	234	475	1100	850	4,71	2		3
NCF 2952 V	260	360	60	730	1430	400	750	18,4	2,1	333,7	
NCF 2952 CV	260	360	60	790	1470	1000	700	18,5	2,1		3,5
NCF 3052 V	260	400	104	1610	2850	380	700	46,5	4	373,5	
NCF 3052 CV	260	400	104	1620	2550	1000	650	44,5	4		11
NCF 1856 V	280	350	33	330	650	400	750	7	2	332	
NCF 1856 CV	280	350	33	315	620	1000	800	7	2		3
NCF 2956 V	280	380	60	890	1700	380	700	19,6	2,1	362,7	
NCF 2956 CV	280	380	60	920	1740	1000	600	19,7	2,1		3,5
NCF 3056 V	280	420	106	1680	3050	360	670	50	4	391,5	
NCF 3056 CV	280	420	106	1670	2700	950	600	48	4		11
NCF 1860 V	300	380	38	400	800	360	670	10	2,1	359	
NCF 1860 CV	300	380	38	380	750	950	700	10	2,1		3,5
NNCF 4860 V	300	380	80	792	2120	380	700	23	2,1		
NCF 2960 V	300	420	72	1100	2200	340	630	30,5	3	390	
NCF 2960 CV	300	420	72	1180	2230	900	550	31,2	3		5
NCF 3060 V	300	460	118	2090	3750	320	600	69	4	432	
NCF 3060 CV	300	460	118	2040	3350	850	500	66,6	4		14
NCF 1864 V	320	400	38	400	800	340	630	10,6	2,1	377	
NCF 1864 CV	320	400	38	390	800	900	650	10,6	2,1		4,5
NCF 2964 V	320	440	72	1140	2300	320	600	32,3	3	410	
NCF 2964 CV	320	440	72	1220	2370	850	500	32,9	3		5
NCF 3064 V	320	480	121	2120	3900	300	560	74,5	4	447,3	
NCF 3064 CV	320	480	121	2100	3500	800	500	71,7	4		14

S\*: indicates maximum axial displacement from the inner ring.

Index other bore sizes

BEARING STEEL 100Cr6

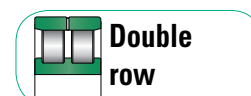
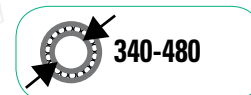

Alternative part number:

Equivalent prefix for NCF:  
SL 18

Equivalent prefix for NJG:  
SL 19

Details part number:

- Suffixes C:  
modified internal design

- Suffixes V:  
version without cage (full complement)



Deep Groove Ball Bearing	Self-Aligning Ball Bearing	Angular Contact Ball Bearing	
<b>Cylindrical Roller Bearing</b>	Tapered Roller Bearing	Spherical Roller Bearing	
Thrust Ball Bearing	Spherical Roller Thrust Bearing	Accessories Adapter & Withdrawal Sleeve	Technical & Related Information



Click here for Technical & Related Information

### 3 5 5 0 0 d

## Cylindrical Roller Bearing - Full Complement - Single Row

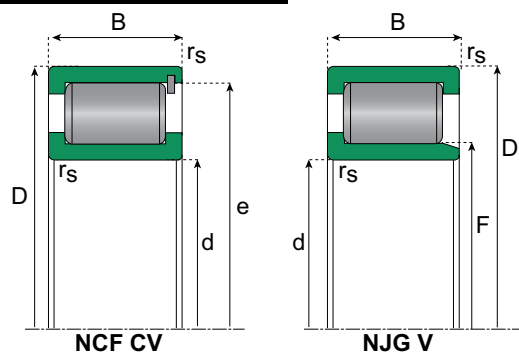
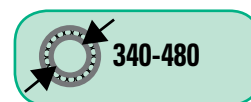

Part number	Principal dimensions			Basic load ratings		Speed limits		Weight Kg	Radius rs min mm	Dimensions	
	Bore d	Outer D	Width B	Dynamic C	Static Co	Grease rpm	Oil rpm			E & F	S*
	mm			kN		1 min <sup>-1</sup>				mm	
NCF 1868 V	340	420	38	410	840	320	600	11,2	2,1	401	
NCF 1868 CV	340	420	38	405	840	850	650	11,2	2,1		4,5
NCF 2968 V	340	460	72	1100	2500	300	560	34,5	3	432	
NCF 2968 CV	340	460	72	1260	2500	800	480	34,7	3		5
NCF 3068 V	340	520	133	2240	4250	280	530	100	5	486	
NCF 3068 CV	340	520	133	2500	4150	750	450	95,8	5		16
NCF 1872 V	360	440	38	420	900	300	560	11,7	2,1	419	
NCF 1872 CV	360	440	38	426	890	800	550	11,7	2,1		4,5
NCF 2972 V	360	480	72	1250	2650	280	530	36	3	450,5	
NCF 2972 CV	360	480	72	1290	2650	750	440	36,4	3		5
NCF 3072 V	360	540	134	2640	4900	260	500	105	5	503,2	
NCF 3072 CV	360	540	134	2650	4350	700	430	101	5		16
NCF 1876 V	380	480	46	600	1200	280	530	19,2	2,1	456	
NCF 1876 CV	380	480	46	590	1190	750	550	19,2	2,1		6
NCF 2976 V	380	520	82	1570	3250	260	500	52,1	4	487	
NCF 2976 CV	380	520	82	1670	3350	700	400	52,1	4		5
NCF 3076 V	380	560	135	2700	5100	240	480	110	5	520,5	
NCF 3076 CV	380	560	135	2600	4500	700	410	106	5		16
NCF 1880 V	400	500	46	620	1300	260	500	19,2	2,1	472	
NCF 1880 CV	400	500	46	600	1260	700	490	20	2,1		6
NCF 2980 V	400	540	82	1500	3300	240	480	52,1	4	511	
NCF 2980 CV	400	540	82	1730	3560	700	370	54,3	4		5
NCF 3080 V	400	600	148	3190	6100	220	450	145	5	559,1	
NCF 3080 CV	400	600	148	3100	5400	650	360	140	5		18
NCF 1884 V	420	520	46	640	1380	240	480	20,9	2,1	496	
NCF 1884 CV	420	520	46	620	1310	700	470	20,9	2,1		6
NCF 2984 V	420	560	82	1750	3600	200	430	55,8	4	524	
NCF 2984 CV	420	560	82	1750	3600	650	360	56,9	4		5
NCF3084 V	420	620	150	3300	6300	200	430	150	5	578,2	
NCF 1888 V	440	540	46	640	1380	220	450	22	2,1	519	
NCF 1888 CV	440	540	46	630	1380	650	440	21,8	2,1		6
NCF 2988 V	440	600	95	2100	4100	200	430	78	4	565,5	
NCF 2988 CV	440	600	95	2100	4150	600	330	78,1	4		7
NCF 3088 V	440	650	157	3740	7350	190	400	175	6	607,5	
NCF 1892 V	460	580	56	800	1700	200	430	33,9	3	553	
NCF 1892 CV	460	580	56	790	1680	600	420	33,9	3		7
NCF 2992 V	460	620	95	2150	4300	190	400	80,8	4	579	
NCF 2992 CV	460	620	95	2140	4300	600	320	81,1	4		7
NCF 3092 V	460	680	163	4130	8000	180	380	195	6	635	
NCF 1896 V	480	600	56	935	2040	190	400	35,5	3	573,5	
NCF 1896 CV	480	600	56	810	1740	600	400	35,2	3		7
NCF 2896 V	480	600	72	1320	3150	190	400	46	3	573,5	
NCF 2996 V	480	650	100	2290	5100	180	380	94,7	5	606	
NCF 2996 CV	480	650	100	2410	4850	550	290	94,7	5		7
NCF 3096 V	480	700	165	4180	8300	170	360	205	6	655,2	

S\*: indicates maximum axial displacement from the inner ring.

Index other bore sizes

BEARING STEEL 100Cr6

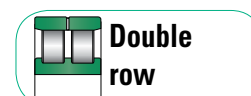

Alternative part number:

Equivalent prefix for **NCF**:  
SL 18  
Equivalent prefix for **NJG**:  
SL 19

Details part number:

- Suffixes **C**:  
modified internal design
- Suffixes **V**:  
version without cage (full complement)



Deep Groove Ball Bearing	Self-Aligning Ball Bearing	Angular Contact Ball Bearing	
<b>Cylindrical Roller Bearing</b>	Tapered Roller Bearing	Spherical Roller Bearing	
Thrust Ball Bearing	Spherical Roller Thrust Bearing	Accessories Adapter & Withdrawal Sleeve	Technical & Related Information



### 3 5 5 0 0 e

## Cylindrical Roller Bearing - Full Complement - Single Row



Click here for Technical & Related Information

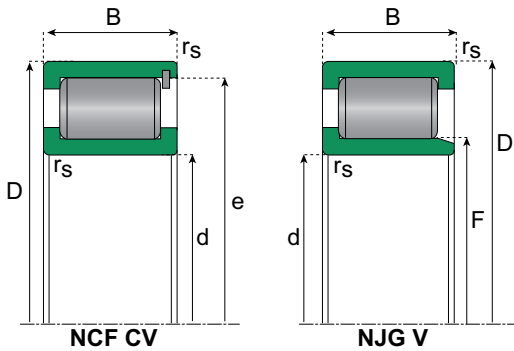

Part number	Principal dimensions			Basic load ratings		Speed limits		Weight Kg	Radius rs min mm	Dimensions	
	Bore d	Outer D	Width B	Dynamic C	Static Co	Grease rpm	Oil rpm			E & F	S*
	mm			kN		1 min <sup>-1</sup>				mm	
NCF 18/500 V	500	620	56	952	2120	180	380	35,5	3	594	
NCF 18/500 CV	500	620	56	830	1830	600	380	36,5	3		7
NCF 28/500 V	500	620	72	1340	3350	180	380	48	3	594	
NCF 29/500 V	500	670	100	2380	5300	170	360	100	5	634,5	
NCF 29/500 CV	500	670	100	2450	5000	550	280	98,3	5		7
NCF 30/500 V	500	720	167	4290	8650	170	360	215	6	676,8	
NCF 18/530 V	530	650	56	990	2240	170	360	37,5	3	624,5	
NCF 18/530 CV	530	650	56	900	2200	600	360	37,9	3		7
NCF 28/530 V	530	650	72	1400	3450	170	360	49,5	3	624,5	
NCF 29/530 V	530	710	106	2700	6000	160	340	120	5	673	
NCF 30/530 V	530	780	185	5230	10600	150	320	300	6	732,3	
NCF 18/560 V	560	680	56	1020	2360	150	320	40,5	3	655	
NCF 18/560 CV	560	680	56	1020	2360	600	340	39,3	3		7
NCF 28/560 V	560	680	72	1420	3650	160	340	54	3	651,5	
NCF 29/560 V	560	750	112	3030	6700	150	320	140	5	709	
NCF 30/560 V	560	820	195	5830	11800	140	300	345	6	770	
NCF 18/600 V	600	730	60	1050	2550	150	320	49,5	3	696	
NCF 18/600 CV	600	730	60	1140	2680	600	320	38,9	3		7
NCF 29/600 V	600	800	118	3360	7500	140	300	170	5	754	
NCF 18/630 V	630	780	69	1250	2900	140	300	70	4	739	
NCF 18/630 CV	630	780	69	1470	3400	600	300	38,8	4		7
NCF 29/630 V	630	850	128	3740	8650	130	280	205	6	807	
NCF 18/670 V	670	820	69	1300	3150	130	280	74	4	783	
NCF 18/670 CV	670	820	69	1520	3550	600	280	72,7	4		7
NCF 29/670 V	670	900	136	3800	8650	120	260	245	6	846	
NCF 29/710 V	710	950	140	3910	9150	110	240	275	6	896	
NCF 18/750 V	750	920	78	1760	4300	110	240	110	5	880	
NCF 28/750 V	750	920	100	2510	6800	110	240	140	5	880	
NCF 29/750 V	750	1000	145	4460	10600	100	220	315	6	938	
NCF 18/800 V	800	980	82	1940	4800	100	220	130	5	936	
NCF 28/800 V	800	980	106	2750	7500	100	220	165	5	936	
NCF 29/800 V	800	1060	150	4950	12200	95	200	360	6	1002	
NCF 29/850 V	850	1120	155	5280	12900	90	190	405	6	1061	
NCF 29/900 V	900	1180	165	5940	14600	80	170	472	6	1120	
NCF 29/950 V	950	1250	175	6660	16300	75	160	565	7,5	1179	
NCF 29/1000 V	1000	1320	185	7480	18600	70	150	680	7,5	1252	
NCF 18/1120 V	1120	1360	106	9960	3720	130	175	366	6		
NCF 18/1400 V	1400	1700	132	15320	5350	90	125	740	7,5		

Index other bore sizes

BEARING STEEL 100Cr6

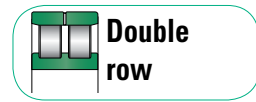

Alternative part number:

Equivalent prefix for **NCF**:  
SL 18  
Equivalent prefix for **NJG**:  
SL 19

Details part number:

- Suffixes **C**: modified internal design
- Suffixes **V**: version without cage (full complement)

S\*: indicates maximum axial displacement from the inner ring.



Deep Groove Ball Bearing	Self-Aligning Ball Bearing	Angular Contact Ball Bearing	
<b>Cylindrical Roller Bearing</b>	Tapered Roller Bearing	Spherical Roller Bearing	
Thrust Ball Bearing	Spherical Roller Thrust Bearing	Accessories Adapter & Withdrawal Sleeve	Technical & Related Information

### 3 5 6 0 0 a

## Cylindrical Roller Bearing - Full Complement - Double Row

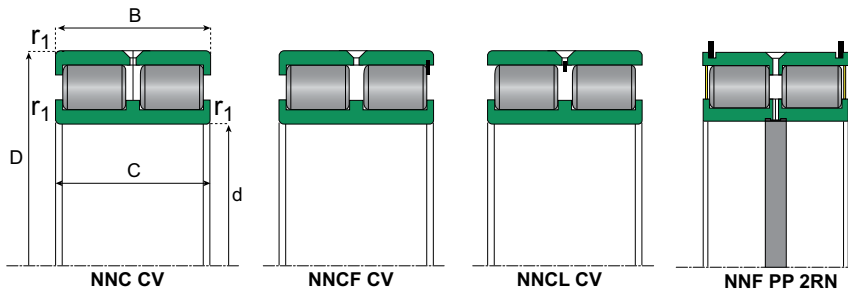

Click here for Technical & Related Information

Index other bore sizes

BEARING STEEL 100Cr6

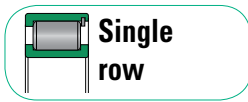

Part number	Principal dimensions			Basic load ratings		Speed limits		Weight	Radius	Dimensions				
	Bore	Outer	Width	Dynamic	Static	Grease	Oil			C	S	C1	m	X
	d	D	B	C	Co	rpm								
mm			kN		1 min <sup>-1</sup>		Kg	rs min mm	mm					
NNF 5004 PP 2NR	20	42	30	40,5	49	4000		0,2	0,3	29		24,7	1,8	22,5
NNCF 5004 CV	20	42	30	47,5	53	9000	10000	0,2	0,6		1			
NNF 5005 PP 2NR	25	47	30	44,5	58	3600		0,24	0,3	29		24,7	1,8	22,5
NNCF 5005 CV	25	47	30	54	65	7000	9000	0,23	0,6		1			
NNF 5006 PP 2NR	30	55	34	50	67	3000		0,37	0,3	33		28,2	2,1	25,5
NNCF 5006 CV	30	55	34	70	86	6500	7500	0,35	1		1,5			
NNF 5007 PP 2NR	35	62	36	69	88	2600		0,48	0,3	35		30,2	2,1	27,5
NNCF 5007 CV	35	62	36	85	109	5500	6500	0,46	1		1,5			
NNF 5008 PP 2NR	40	68	38	76	103	2400		0,56	0,6	37		32,2	2,7	28,5
NNCF 5008 CV	40	68	38	101	136	5000	6000	0,56	1		1,5			
NNF 5009 PP 2NR	45	75	40	92	130	2200		0,7	0,6	39		34,2	2,7	30,5
NNCF 5009 CV	45	75	40	108	151	4700	5500	0,71	1		1,5			
NNF 5010 PP 2NR	50	80	40	97	142	2000		0,76	0,6	39		34,2	2,7	30,5
NNCF 5010 CV	50	80	40	131	191	4200	5000	0,76	1	40	1,5			
NNF 5011 PP 2NR	55	90	46	115	175	1800		1,18	0,6	45		40,2	3,2	36
NNCF 5011 CV	55	90	46	184	275	3800	4500	1,16	1,1		1,5			
NNC 4912 CV	60	85	25	71	125	3200	4500	0,49	1					
NNCL 4912 CV	60	85	25	71	125	3200	4500	0,47	1		1			
NNF 5012 PP 2NR	60	95	46	120	189	1700		1,26	0,6	45		40,2	3,2	36
NNCF 5012 CV	60	95	46	189	290	3400	4200	1,24	1,1		1,5			
NNF 5013 PP 2NR	65	100	46	125	203	1600		1,33	0,6	45		40,2	3,2	36
NNCF 5013 CV	65	100	46	199	320	3100	3900	1,32	1,1		1,5			
NNC 4914 CV	70	100	30	108	189	2800	3800	0,78	1					
NNCL 4914 CV	70	100	30	108	189	2800	3800	0,75	1		1			
NNF 5014 PP 2NR	70	110	54	168	265	1400		1,87	0,6	53		48,2	4,2	42
NNCF 5014 CV	70	110	54	235	355	3100	3600	1,85	1,1		3			
NNF 5015 PP 2NR	75	115	54	194	300	1400		1,96	0,6	53		48,2	4,2	42
NNCF 5015 CV	75	115	54	248	390	2700	3400	1,93	1,1		3			
NNC 4916 CV	80	110	30	115	211	2500	3400	0,88	1					
NNCL 4916 CV	80	110	30	115	211	2500	3400	0,85	1		1			
NNF 5016 PP 2NR	80	125	60	203	325	1300		2,71	0,6	59		54,2	4,2	48
NNCF 5016 CV	80	125	60	295	450	2500	3200	2,59	1,1		3,5			
NNF 5017 PP 2NR	85	130	60	211	350	1200		2,83	0,6	59		54,2	4,2	48
NNCF 5017 CV	85	130	60	305	475	2400	3000	2,72	1,1		3,5			
NNC 4918 CV	90	125	35	155	295	2300	3000	1,35	1,1					
NNCL 4918 CV	90	125	35	155	295	2300	3000	1,3	1,1		1,5			
NNF 5018 PP 2NR	90	140	67	305	510	1100		3,71	0,6	66		59,2	4,2	54
NNCF 5018 CV	90	140	67	355	560	2200	2800	3,62	1,5		4			
NNF 5019 PP 2NR	95	145	67	315	530	1100		3,88	0,6	66		59,2	4,2	54
NNC 4920 CV	100	140	40	196	380	2000	2700	1,95	1,1					
NNCL 4920 CV	100	140	40	196	380	2000	2700	1,9	1,1		2			
NNF 5020 PP 2NR	100	150	67	330	550	1000		3,95	0,6	66		59,2	4,2	54
NNCF 5020 CV	100	150	67	375	620	2000	2600	3,94	1,5		4			
NNC4922 CV	110	150	40	204	410	1800	2500	2,15	1,1					
NNCL 4922 CV	110	150	40	204	410	1800	2500	2,1	1,1		2			
NNF 5022 PP 2NR	110	170	80	395	680	900		6,57	0,6	79		70,2	4,2	64
NNCF 5022 CV	110	170	80	490	790	1800	2300	6,32	2		5			

### Alternative part number:

- Equivalent prefix for **NNF**: SL 04
- Equivalent prefix for **NNCF**: SL 18
- Equivalent prefix for **NNC**: SL 01
- Equivalent prefix for **NNCL**: SL 02

### Details part number:

- Suffixes **C**: modified internal design
- Suffixes **V**: version without cage (full complement)
- Suffixes **PP 2NR**: version with 2 snap ring grooves and including 2 polyurethane seals, and 2 snap rings.





Deep Groove Ball Bearing	Self-Aligning Ball Bearing	Angular Contact Ball Bearing	
<b>Cylindrical Roller Bearing</b>	Tapered Roller Bearing	Spherical Roller Bearing	
Thrust Ball Bearing	Spherical Roller Thrust Bearing	Accessories Adapter & Withdrawal Sleeve	Technical & Related Information



Click here for Technical & Related Information

### 3 5 6 0 0 b

## Cylindrical Roller Bearing - Full Complement - Double Row

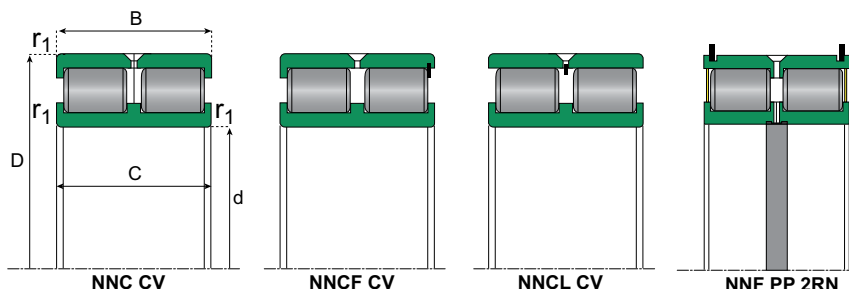
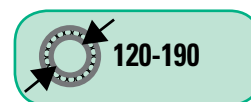

Part number	Principal dimensions			Basic load ratings		Speed limits		Weight	Radius	Dimensions				
	Bore	Outer	Width	Dynamic	Static	Grease	Oil			C	S	C1	m	X
	d	D	B	C	Co	rpm								
mm			kN		1 min <sup>-1</sup>		Kg	rs min mm	mm					
NNC 4924 CV	120	165	45	228	455	1700	2300	2,95	1,1					
NNCL4924 CV	120	165	45	228	455	1700	2300	2,85	1,1		3			
NNF 5024 PP 2NR	120	180	80	410	740	900		7,04	0,6	79		71,2	4,2	64
NNCF 5024 CV	120	180	80	520	870	1600	2200	677	2		5			
NNC 4926 CV	130	180	50	265	530	1500	2100	3,95	1,5					
NNCL 4926 CV	130	180	50	265	530	1500	2100	3,8	1,5		4			
NNF 130 PP 2NR	130	190	80	430	790	800		7,5	0,6	79		71,2	4,2	64
NNF 5026 PP 2NR	130	200	95	540	960	800		10,5	0,6	94		83,2	4,2	77
NNCF 5026 CV	130	200	95	740	1230	1400	2000	10,2	2		5			
NNC 4928 CV	140	190	50	275	570	1400	2000	4,2	1,5					
NNCL 4928 CV	140	190	50	275	570	1400	2000	4,1	1,5		4			
NNF 140 PP 2NR	140	200	80	445	840	750		8	0,6	79		72,1	4,2	64
NNF 5028 PP 2NR	140	210	95	610	1100	750		11,1	0,6	94		83,2	5,2	77
NNCF 5028 CV	140	210	95	780	136	1200	1900	11,1	2		5			
NNC 4830 CV	150	190	40	237	550	1300	1900	2,9	1,1					
NNCL 4830 CV	150	190	40	237	550	1300	1900	2,8	2		2			
NNCF 4830 V	150	190	40	230	580	1500	1200	2,8						
NNC 4930 CV	150	210	60	415	840	1200	1800	6,65	2					
NNCL 4930 CV	150	210	60	415	840	1200	1900	6,45	2		4			
NNF 150 PP 2NR	150	210	80	465	920	700		8,4	0,6	79		71,2	5,2	64
NNF 5030 PP 2NR	150	225	100	710	1260	700		13,3	0,6	99		87,2	5,2	80
NNCF 5030 CV	150	225	100	820	1420	1200	1700	13,3	2		6			
NNC 4832 CV	160	200	40	243	580	1300	1800	3,1	2,1					
NNCL 4832 CV	160	200	40	243	580	1200	1800	3	1,1		2			
NNC 4932 CV	160	220	60	435	900	1100	1700	7	2					
NNCL 4932 CV	160	220	60	435	900	1100	1700	6,8	2		4			
NNF 160 PP 2NR	160	220	80	480	970	700		8,8	0,6	79		71,2	5,2	64
NNF 5032 PP 2NR	160	240	109	740	1360	650		16,6	0,6	108		95,2	5,2	89
NNCF 5032 CV	160	240	109	895	1620	1200	1500	15,8	2,1		6			
NNC 4834 CV	170	215	40	265	620	1200	1700	4,1	1,1					
NNCL 4834 CV	170	215	40	265	620	1200	1700	3,95	1,1		3			
NNC 4934 CV	170	230	60	445	950	1000	1600	7,35	2					
NNCL 4934 CV	170	230	60	445	950	1000	1600	7,1	2		4			
NNF 170 PP 2NR	170	230	80	490	1030	650		9,3	0,6	79		71,2	5,2	64
NNF 5034 PP 2NR	170	260	122	960	1750	600		22,6	0,6	121		107,2	5,2	100
NNCF 5034 CV	170	260	122	1230	2120	1100	1400	23	2,1		6			
NNC 4836 CV	180	225	45	275	660	1100	1600	4,3	1,1					
NNCL 4836 CV	180	225	45	275	660	1100	1600	4,15	1,1		3			
NNF 180 PP 2NR	180	240	80	500	1080	600		9,8	0,6	79		71,2	5,2	64
NNC 4936 CV	180	250	69	580	1230	950	1500	10,8	2					
NNCL 4936 CV	180	250	69	580	1230	950	1500	10,5	2		4			
NNF 5036 PP 2NR	180	280	136	1140	2130	550		30,1	0,6	135		118,2	5,2	112
NNCF 5036 CV	180	280	136	1420	2500	1100	1300	30,5	2,1		8			
NNC 4838 CV	190	240	50	315	750	1100	1500	5,65	1,5					
NNCL 4838 CV	190	240	50	315	750	1100	1500	5,45	1,5		4			
NNC 4938 CV	190	260	69	590	1290	900	1400	11,2	2					
NNCL 4938 CV	190	260	69	590	1290	900	1400	10,9	2		4			
NNF 190 PP 2NR	190	260	80	520	1130	550		12,7	0,6	79		73,2	5,2	64
NNF 5038 PP 2NR	190	290	136	1160	2210	550		31,5	0,6	135		118,2	5,2	112
NNCF 5038 CV	190	290	136	1470	2600	1000	1300	31,5	2,1		8			

Index other bore sizes

BEARING STEEL 100Cr6

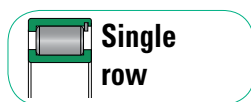
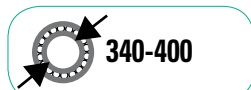

### Alternative part number:

- Equivalent prefix for **NNF**: SL 04
- Equivalent prefix for **NNCF**: SL 18
- Equivalent prefix for **NNC**: SL 01
- Equivalent prefix for **NNCL**: SL 02

### Details part number:

- Suffixes **C**: modified internal design
- Suffixes **V**: version without cage (full complement)
- Suffixes **PP 2NR**: version with 2 snap ring grooves and including 2 polyurethane seals, and 2 snap rings.



Deep Groove Ball Bearing	Self-Aligning Ball Bearing	Angular Contact Ball Bearing	
<b>Cylindrical Roller Bearing</b>	Tapered Roller Bearing	Spherical Roller Bearing	
Thrust Ball Bearing	Spherical Roller Thrust Bearing	Accessories Adapter & Withdrawal Sleeve	Technical & Related Information



Click here for Technical & Related Information

### 3 5 6 0 0 C

## Cylindrical Roller Bearing - Full Complement - Double Row

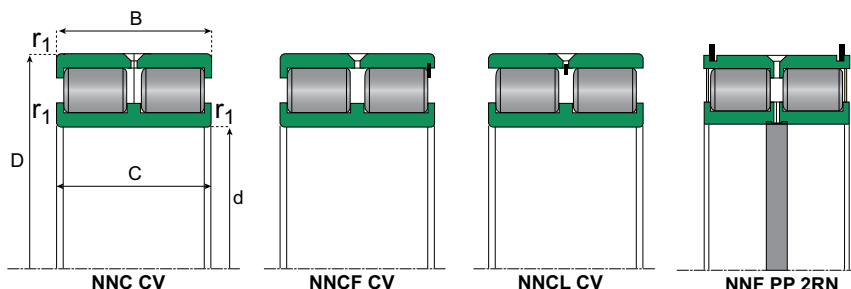
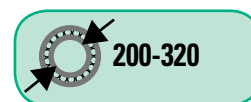

Part number	Principal dimensions			Basic load ratings		Speed limits		Weight Kg	Radius rs min mm	Dimensions				
	Bore d	Outer D	Width B	Dynamic C	Static Co	Grease rpm	Oil rpm			C	S	C1	m	X
	mm			kN		1 min <sup>-1</sup>				mm				
NNC 4840 CV	200	250	50	325	790	1000	1400	5,9	1,5					
NNCL 4840 CV	200	250	50	325	790	1000	1400	5,7	1,5		4			
NNF 200 PP 2NR	200	270	80	540	1210	550		13,2	0,6	79		73,2	5,2	64
NNC 4940 CV	200	280	80	690	1480	850	1400	15,8	2,1					
NNCL 4940 CV	200	280	80	690	1480	850	1400	15,3	2,1		5			
NNF 5040 PP 2NR	200	310	150	1350	2600	500		40,8	0,6	149		128,2	6,3	126
NNCF 5040 CV	200	310	150	1860	3050	950	1200	41	2,1		9			
NNC 4844 CV	220	270	50	340	870	850	1300	6,4	1,5					
NNCL 4844 CV	220	270	50	340	870	850	1300	6,2	1,5		4			
NNC 4944 CV	220	300	80	720	1590	750	1200	17,2	2,1					
NNCL 4944 CV	220	300	80	720	1590	750	1200	16,7	2,1		5			
NNF 220 PP 2NR	220	300	95	700	1550	480		19,5	1	94		83,2	5,2	72
NNF 5044 PP 2NR	220	340	160	1570	3050	480		52,5	1	159		138,2	6,3	132
NNCF 5044 CV	220	340	160	2010	3600	850	1100	52,5	3		9			
NNC 4848 CV	240	300	60	520	1290	750	1200	10	2					
NNCL 4848 CV	240	300	60	520	1290	750	1200	9,9	2		4			
NNC 4948 CV	240	320	80	750	1740	700	1200	18,5	2,1					
NNCL 4948 CV	240	320	80	750	1740	700	1200	17,9	2,1		5			
NNF 240 PP 2NR	240	320	95	740	1700	480		21	1	94		83,2	6,3	72
NNF 5048 PP 2NR	240	360	160	1630	3300	440		56	1	159		138,2	6,3	132
NNCF 5048 CV	240	360	160	2120	3900	800	1000	56	3		9			
NNC 4852 CV	260	320	60	540	1400	700	1100	11	2					
NNCL 4852 CV	260	320	60	540	1400	700	1100	10,6	2		4			
NNF 260 PP 2NR	260	340	95	840	1990	440		22,5	1	94		83,2	6,3	75
NNC 4952 CV	260	360	100	1120	2500	600	1000	32	2,1					
NNCL 4952 CV	260	360	100	1120	2500	600	1000	31,2	2,1		6			
NNF 5052 PP 2NR	260	400	190	2380	4700	400		84,5	1,1	189		162,2	6,3	150
NNCF 5052 CV	260	400	190	2860	5200	700	900	85,5	4		10			
NNC 4856 CV	280	350	69	710	1860	600	1000	16	2					
NNCL 4856 CV	280	350	69	710	1860	600	1000	15,6	2		4			
NNC 4956 CV	280	380	100	1170	2700	550	1000	34	2,1					
NNCL 4956 CV	280	380	100	1170	2700	550	1000	33,1	2,1		6			
NNF 5056 PP 2NR	280	420	190	2600	5200	380		90	1,1	189		163,2	7,3	150
NNCF 5056 CV	280	420	190	2920	5600	670	850	90,5	4		10			
NNC 4860 CV	300	380	80	830	2120	550	950	23	2,1					
NNCL 4860 CV	300	380	80	830	2120	550	950	22	2,1		6			
NNCF 4860 V	300	380	80	792	2120	700	380	23	2,1					
NNCF 4860 V	300	380	80	792	2120	700	380	23	2,1					
NNF 300 PP 2NR	300	380	95	900	2250	380		25,5	1	94		83,2	6,3	75
NNC 4960 CV	300	420	118	1650	3800	460	900	53	3					
NNCL 4960 CV	300	420	118	1650	3800	460	900	51,9	3		6			
NNF 5060 PP 2NR	300	460	218	3000	5800	340		126	1,1	216		185,2	7,3	170
NNCF 5060 CV	300	460	218	3250	6550	600	750	130	4		9			
NNC 4864 CV	320	400	80	860	2280	500	900	24	2,1					
NNCL 4864 CV	320	400	80	860	2280	500	900	23,5	2,1		6			
NNC 4964 CV	320	440	118	1720	4100	410	850	56	3					
NNCL 4964 CV	320	440	118	1720	4100	410	850	54,9	3		6			
NNCF 5064 CV	320	480	218	3690	6950	560	700	135	4		9			

Index other bore sizes

BEARING STEEL 100Cr6

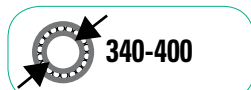

### Alternative part number:

- Equivalent prefix for **NNF**: SL 04
- Equivalent prefix for **NNCF**: SL 18
- Equivalent prefix for **NNC**: SL 01
- Equivalent prefix for **NNCL**: SL 02

### Details part number:

- Suffixes **C**: modified internal design
- Suffixes **V**: version without cage (full complement)
- Suffixes **PP 2NR**: version with 2 snap ring grooves and including 2 polyurethane seals, and 2 snap rings.



Deep Groove Ball Bearing	Self-Aligning Ball Bearing	Angular Contact Ball Bearing	
<b>Cylindrical Roller Bearing</b>	Tapered Roller Bearing	Spherical Roller Bearing	
Thrust Ball Bearing	Spherical Roller Thrust Bearing	Accessories Adapter & Withdrawal Sleeve	Technical & Related Information



### 3 5 6 0 0 d

## Cylindrical Roller Bearing - Full Complement - Double Row

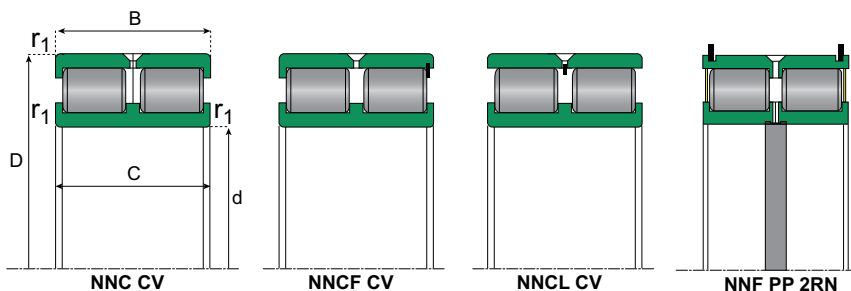
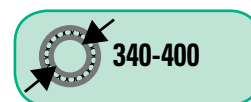

Click here for Technical & Related Information

Part number	Principal dimensions			Basic load ratings		Speed limits		Weight	Radius	Dimensions				
	Bore	Outer	Width	Dynamic	Static	Grease	Oil			C	S	C1	m	X
	d	D	B	C	Co	rpm								
mm			kN		1 min <sup>-1</sup>		Kg	rs min mm	mm					
NNC 4868 CV	340	420	80	880	2390	480	850	25,5	2,1					
NNCL 4868 CV	340	420	80	880	2390	480	850	25	2,1		6			
NNC 4968 CV	340	460	118	1770	4300	390	800	59	3					
NNCL 4968 CV	340	460	118	1770	4300	390	800	57,8	3		6			
NNCF 5068 CV	340	520	243	4400	8300	530	670	185	5		11			
NNC 4872 CV	360	440	80	910	2550	440	800	27	2,1					
NNCL 4872 CV	360	440	80	910	2550	440	800	26	2,1		6			
NNC 4972 CV	360	480	118	1810	4500	370	750	62,1	3					
NNCL 4972 CV	360	480	118	1810	4500	370	750	60,8	3		6			
NNCF 5072 CV	360	540	243	4460	8650	500	630	195	5		11			
NNC 4876 CV	380	480	100	1330	3550	400	750	45,5	2,1					
NNCL 4876 CV	380	480	100	1330	3550	400	750	44	2,1		6			
NNCL 4976 CV	380	520	140	2280	5600	340	700	90,5	4		7			
NNC 4976 CV	380	520	140	2280	5600	340	700	92,4	4					
NNCF 5076 CV	380	560	243	4680	9150	480	600	200	5		11			
NNC 4980 CV	400	540	140	2340	5900	310	700	96,5	4					
NNCL 4980 CV	400	540	140	2340	5900	310	700	96,5	4		7			

[Index other bore sizes](#)

**BEARING STEEL 100Cr6**

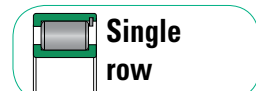

### Alternative part number:

- Equivalent prefix for **NNF**: SL 04
- Equivalent prefix for **NNCF**: SL 18
- Equivalent prefix for **NNC**: SL 01
- Equivalent prefix for **NNCL**: SL 02

### Details part number:

- Suffixes **C**: modified internal design
- Suffixes **V**: version without cage (full complement)
- Suffixes **PP 2NR**: version with 2 snap ring grooves and including 2 polyurethane seals, and 2 snap rings.





Deep Groove Ball Bearing	Self-Aligning Ball Bearing	Angular Contact Ball Bearing	
Cylindrical Roller Bearing	<b>Tapered Roller Bearing</b>	Spherical Roller Bearing	
Thrust Ball Bearing	Spherical Roller Thrust Bearing	Accessories Adapter & Withdrawal Sleeve	Technical & Related Information



# 40010a

## Tapered Roller Bearing

### Introduction

Tapered roller bearings are designed to take radial and thrust loads from one direction. They consist of the inner race (cone), with cage guided rollers, and the outer race (cup). The track has the same profile as the tapered rollers. The extension of the contact lines meet at a common point on the bearing axis of rotation. The cone and cup are separable. By using two bearings as opposed mountings, they can carry thrust loadings in both directions.

Single row tapered roller bearings can be supplied matched in "DB" or "DF" arrangement. These matched bearings are manufactured so that, when mounted opposite each other, the pair should have an established initial axial clearance and a uniform distribution of the loading. Matched bearings are used when the load carrying capacity of a single bearing is insufficient, or when the thrust loads have to be carried at a certain axial clearance in both directions.

Dimensions in accordance with ISO 355-2007



Click here for  
Technical & Related  
Information

### Axial clearance

The axial clearance of single tapered roller bearings is adjusted on assembly. With matched bearings, as with double and 4 row bearings, axial clearance is achieved by the addition of spacer rings ground to give the required clearance. Radial clearances for double and four row tapered roller bearings are shown in the technical section. The radial clearance is transformed into axial clearance by the following relation:

$$\text{Axial clearance} = \frac{\text{Radial clearance}}{2 \tan \alpha}$$

$\alpha$  = contact angle between rollers and the outer ring raceway

### Basic types and design variants

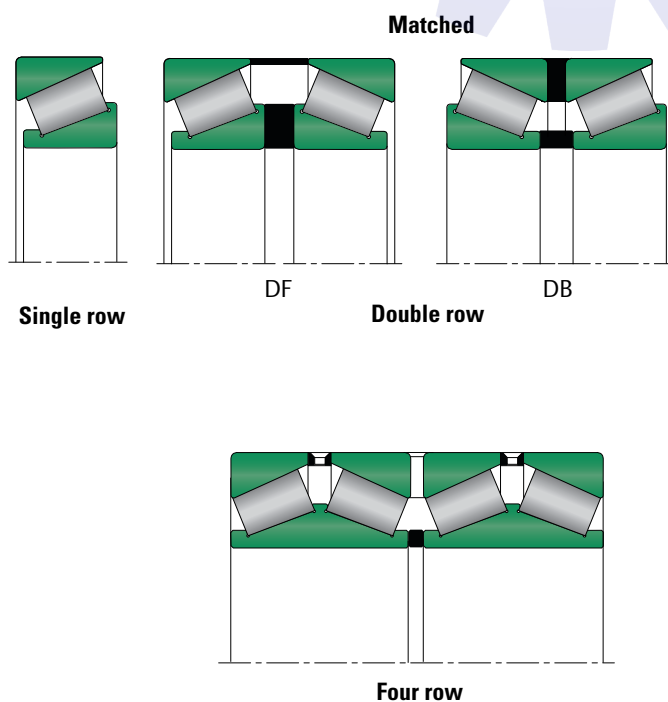



Deep Groove Ball Bearing	Self-Aligning Ball Bearing	Angular Contact Ball Bearing	
Cylindrical Roller Bearing	<b>Tapered Roller Bearing</b>	Spherical Roller Bearing	
Thrust Ball Bearing	Spherical Roller Thrust Bearing	Accessories Adapter & Withdrawal Sleeve	Technical & Related Information

# 40100a

## Tapered Roller Bearing



Click here for Technical & Related Information

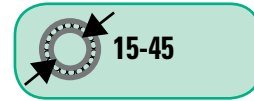
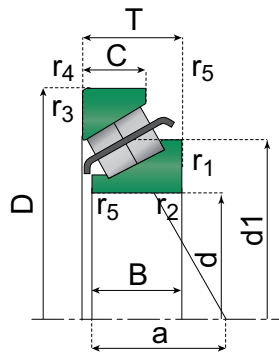

Part number	Principal dimensions			Load ratings		Speed limits		Weight Kg	B	C	Dimensions			Calculation factors			
	Bore	Outer	Width	Dynamic	Static	Grease	Oil				r1/r2	r3/r4	r5	a	e	Y	Yo
	d	D	T	C	Co	rpm					mm			mm			
	mm			kN		1 min <sup>-1</sup>											
30202	15	35	11,75	15,8	14,4			0,053	11	10	0,6	0,6					
30302	15	42	14,25	23,9	21,6	9000	13000	0,09	13	11	1	1	0,3	9	0,28	2,1	1,1
30203	17	40	13,25	21,2	21,3	9000	13000	0,08	12	11	1	1	0,3	10	0,35	1,7	0,9
30303	17	47	15,25	29,7	27,2	8500	12000	0,13	14	12	1	1	0,3	10	0,28	2,1	1,1
32004	20	42	15	26,3	30	8500	12000	0,097	15	12	0,6	0,6	0,3	10	0,37	1,6	0,9
30204	20	47	15,25	28,2	30,6	8000	11000	0,12	14	12	1	1	0,3	11	0,35	1,7	0,9
32204	20	47	19,25	37	40,6			0,161	18	15	1	1					
30304	20	52	16,25	34,7	33,2	8000	11000	0,17	15	13	1,5	1,5	0,6	11	0,3	2	1,1
32304	20	52	22,25	44,6	46,3	7500	10000	0,221	21	18	1,5	1,5	0,6	14	0,3	2	1,1
32005	25	47	15	28	34,1	7900	11000	0,112	15	11,5	0,6	0,6	0,3	11,6	0,43	1,39	0,77
33005	25	47	17	32,5	42,5			0,131	17	14	0,6	0,6					
30205	25	52	16,25	29,4	22,54	7500	10000	0,15	15	13	1	1	0,3	12	0,37	1,6	0,9
32205	25	52	19,25	43	48	7500	10000	0,184	18	16	1	1	0,3	16	0,33	1,8	1
33205	25	52	22	47,1	55,8			0,215	22	18	1	1					
30305	25	62	18,25	49,2	48,1	6700	9000	0,25	17	15	1,5	1,5	0,6	13	0,3	2	1,1
31305 A	25	62	18,25	40,7	46,1	5600	7500	0,255	17	13	1,5	1,5	0,6	20	0,83	0,7	0,4
32305	25	62	25,25	64,6	68,8	6000	8000	0,36	24	20	1,5	1,5	0,6	15	0,3	2	1,1
32006	30	55	17	38	48,9	6700	9000	0,017	17	13	1	1	0,3	13	0,43	1,4	0,8
30206	30	62	17,25	45,4	50,5	6300	8500	0,22	16	14	1	1	0,3	14	0,37	1,6	0,9
32206	30	62	21,25	54,3	63,7	6300	8500	0,28	20	17	1	1	0,3	15	0,37	1,6	0,9
30306	30	72	20,75	61,7	63,1	5600	7500	0,38	19	16	1,5	1,5	0,6	15	0,31	1,9	1,1
31306	30	72	20,75	52,5	60,3	5000	6700	0,39	19	14	1,5	1,5	0,6	22	0,83	0,7	0,4
32306	30	72	28,75	85,5	96,4	5300	7000	0,55	27	23	1,5	1,5	0,6	18	0,31	1,9	1,1
32007	35	62	18	42	56	6000	8000	0,22	18	14	1	1	0,3	15	0,46	1,3	0,7
30207	35	72	18,25	56,8	63,5	5300	7000	0,32	17	15	1,5	1,5	0,6	15	0,37	1,6	0,9
32207	35	72	24,25	74	89,5	5300	7000	0,42	23	19	1,5	1,5	0,6	17	0,37	1,6	0,9
33207	35	72	28	87,9	107	5700	7500										
30307	35	80	22,75	78,8	82,6	5000	6700	0,52	21	18	2	1,5	0,6	16	0,31	1,9	1,1
31307	35	80	22,75	67,9	76,3	4500	6000	0,52	21	15	2	1,5	0,6	25	0,83	0,7	0,4
32307	35	80	32,75	103,6	118,3	4800	6300	0,73	31	25	2	1,5	0,6	20	0,31	1,9	1,1
32008	40	68	19	47	67,3	5300	7000	0,27	19	14,5	1	1	0,3	15	0,37	1,6	0,9
30208	40	80	19,75	63	74	4800	6300	0,42	18	16	1,5	1,5	0,6	16	0,37	1,6	0,9
32208	40	80	24,75	77,9	97,2	4800	6300	0,51	23	19	1,5	1,5	0,6	19	0,37	1,6	0,9
30308	40	90	25,25	95,2	107,5	4500	6000	0,7	23	20	2	1,5	0,6	19	0,35	1,7	0,9
31308	40	90	25,25	81,4	96,4	4000	5300	0,685	23	17	2	1,5	0,6	28	0,83	0,7	0,4
32308	40	90	35,25	120,8	147,1	4000	5300	0,993	33	27	2	1,5	0,6	23	0,35	1,7	0,9
32009	45	75	20	57	82,2	4800	6300	0,33	20	15,5	1	1	0,3	16	0,4	1,5	0,8
33009	45	75	24														
33109	45	80	26	87,1	117,2			0,536	26	20,5	1,5	1,5					
30209	45	85	20,75	71,3	83,8	4500	6000	0,47	19	16	1,5	1,5	0,6	18	0,4	1,5	0,8
32209	45	85	24,75	84,1	103	4500	6000	0,56	23	19	1,5	1,5	0,6	20	0,4	1,5	0,8
33209	45	85	32	109,5	145,1			0,771	32	25	2	2					
30309	45	100	27,25	114,05	129,8	4000	5300	0,92	25	22	2	1,5	0,6	21	0,35	1,7	0,9
31309	45	100	27,25	95,6	113,8	3400	4500	0,915	25	18	2	1,5	0,6	31	0,83	0,7	0,4
32309	45	100	38,25	145,3	189,4	3600	4800	1,25	36	30	2	1,5	0,6	25	0,35	1,7	0,9

Index other bore sizes

BEARING STEEL 100Cr6

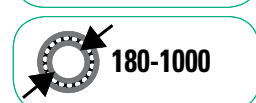

Details part number:  
- Suffix **A**:  
increased loadcapacity





Deep Groove Ball Bearing	Self-Aligning Ball Bearing	Angular Contact Ball Bearing	
Cylindrical Roller Bearing	<b>Tapered Roller Bearing</b>	Spherical Roller Bearing	
Thrust Ball Bearing	Spherical Roller Thrust Bearing	Accessories Adapter & Withdrawal Sleeve	Technical & Related Information

# 40100b

## Tapered Roller Bearing

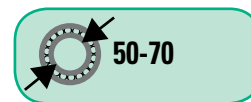
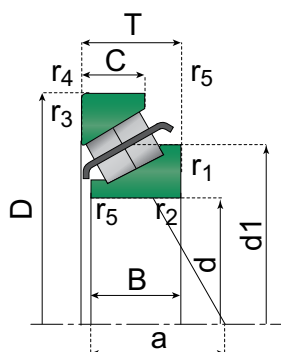

Click here for Technical & Related Information

Part number	Principal dimensions			Load ratings		Speed limits		Weight Kg	B	C	Dimensions			Calculation factors			
	Bore	Outer	Width	Dynamic	Static	Grease	Oil				r1/r2	r3/r4	r5	a	e	Y	Yo
	d	D	T	C	Co						mm			mm			
32010	50	80	20	60	88	4500	6000	0,36	20	15,5	1	1	0,3	18	0,43	1,4	0,8
33010	50	80	24	74,2	111,8	4600	6100										
33110	50	85	26	89,5	126,2	4400	5900	0,595	26	20	1,5	1,5		20	0,4	1,5	0,8
30210	50	90	21,75	73,3	92,1	4300	5600	0,53	20	17	1,5	1,5	0,6	19	0,43	1,4	0,8
32210	50	90	24,75	86,7	107,6	4300	5600	0,6	23	19	1,5	1,5	0,6	21	0,43	1,4	0,8
33210	50	90	32														
30310	50	110	29,25	130,1	157,1	3600	4800	1,19	27	23	2,5	2	0,6	23	0,35	1,7	0,9
31310	50	110	29,25	108	128,25	3200	4300	1,16	27	19	2,5	2	0,6	34	0,83	0,7	0,4
32310	50	110	42,25	177,5	236,1	3200	4300	1,83	40	33	2,5	2	0,6	27	0,35	1,7	0,9
32011	55	90	23	79,7	115,6	4000	5300	0,54	23	17,5	1,5	1,5	0,6	20	0,4	1,5	0,8
33111	55	95	30	116,5	162,4	4000	5300										
30211	55	100	22,75	94,6	112,8	3800	5000	0,69	21	18	2	1,5	0,6	20	0,4	1,5	0,8
32211	55	100	26,75	112,7	141,5	3600	4900	0,83	25	21	2	1,5	0,5	22,83	0,4	1,48	0,81
30311	55	120	31,5	153,3	187,6	3200	4300	1,53	29	25	2,5	2	0,6	24	0,35	1,7	0,9
31311	55	120	31,5	129,9	158	2800	3800	1,49	29	21	2,5	2	0,6	37	0,83	0,7	0,4
32311	55	120	45,5	212,7	271,3	3000	4000	2,21	43	35	2,5	2	0,6	29	0,35	1,7	0,9
32012	60	95	23	83,8	121,5	3800	5000	0,58	23	17,5	1,5	1,5	0,6	21	0,43	1,4	0,8
33112	60	100	30	123,5	179	3700	5000										
30212	60	110	23,75	103,3	130	3400	4500	0,86	22	19	2	1,5	0,6	22	0,4	1,5	0,8
32212	60	110	29,75	132,8	179,6	3400	4500	1,1	28	24	2	1,5	0,6	24	0,4	1,5	0,8
33212	60	110	38	165,8	231,4	3000	4000	1,5	38	29	2	1,5	0,6	28	0,4	1,48	0,82
30312	60	130	33,5	171,4	210	3000	4000	1,9	31	26	3	2,5	1	26	0,35	1,7	0,9
31312	60	130	33,5	145,4	176,8	2600	3600	1,83	31	22	3	2,5	1	39	0,83	0,7	0,4
32312	60	130	48,5	226,7	303	2600	3600	2,8	46	37	3	2,5	1	31	0,35	1,7	0,9
32013	65	100	23	80,6	123	3400	4500	0,62	23	17,5	1,5	1,5	0,6	22	0,46	1,3	0,7
33013	65	100	27	100,5	162,7	3600	4800										
33113	65	110	34	153,6	224,6	3400	4600	1,3	34	26,5	1,5	1,5					
30213	65	120	24,75	120,6	152,6	3000	4000	1,1	23	20	2	1,5	0,6	23	0,4	1,5	0,8
32213	65	120	32,75	160,9	221,7	3000	4000	1,48	31	27	2	1,5	0,6	27	0,4	1,5	0,8
33213	65	120	41	202,2	281,6	3100	4200	1,99	41	32	2	1,5	0,5	29,5	0,39	1,53	0,84
30313	65	140	36	195,9	241,7	2600	3600	2,3	33	28	3	2,5	1	28	0,35	1,7	0,9
31313	65	140	36	165,7	202,6	2200	3200	2,25	33	23	3	2,5	1	42	0,83	0,7	0,4
32313	65	140	51	256	322	2400	3400	3,49	48	39	3	2,5	1	33	0,35	1,7	0,9
32014	70	110	25	95,6	143	3200	4300	0,83	25	19	1,5	1,5	0,6	23	0,43	1,4	0,8
33014	70	110	31	127	204	3200	4200	1,07									
33114	70	120	37	172	250	4000	5300	1,7									
30214	70	125	26,25	138,3	173,7	3000	4000	1,22	24	21	2	1,5	0,6	25	0,43	1,4	0,8
32214	70	125	33,25	168,5	237,1	2800	3800	1,56	31	27	2	1,5	0,6	28	0,43	1,4	0,8
33214	70	125	41	204	290	2900	3900	2,1	41	32	2	1,5	0,8	30,7	0,41	1,47	0,81
30314	70	150	38	219	271,7	2400	3400	3	35	30	3	2,5	1	29	0,35	1,7	0,9
32314	70	150	54	297	381	2200	3200	4,1	51	42	3	2,5	1	36	0,35	1,7	0,9

Index other bore sizes

BEARING STEEL 100Cr6





Deep Groove Ball Bearing	Self-Aligning Ball Bearing	Angular Contact Ball Bearing	
Cylindrical Roller Bearing	<b>Tapered Roller Bearing</b>	Spherical Roller Bearing	
Thrust Ball Bearing	Spherical Roller Thrust Bearing	Accessories Adapter & Withdrawal Sleeve	Technical & Related Information

# 40100C

## Tapered Roller Bearing

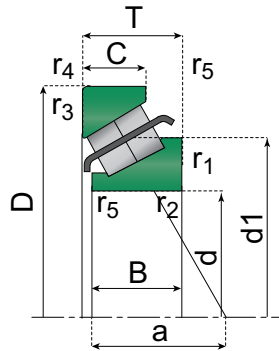

Click here for Technical & Related Information

Part number	Principal dimensions			Load ratings		Speed limits		Weight	B	C	Dimensions			Calculation factors			
	Bore	Outer	Width	Dynamic	Static	Grease	Oil				r1/r2	r3/r4	r5	a	e	Y	Yo
	d	D	T	C	Co						mm			mm			
	mm			kN		rpm		Kg									
						1 min <sup>-1</sup>											
32015	75	115	25	103,1	160,2	3000	4000	0,88	25	19	1,5	1,5	0,6	25	0,46	1,3	0,7
33015	75	115	31	129	212	3000	4000	1,13									
33115	75	125	37	176	265	3800	5000	1,8									
30215	75	130	27,25	138,4	185,4	2800	3800	1,33	25	22	2	1,5	0,6	27	0,43	1,4	0,8
32215	75	130	33,25	170,3	242,1	2600	3600	2,62	31	27	2	1,5	0,6	29	0,43	1,4	0,8
33215	75	130	41	208	298	2700	3600	2,2									
30315	75	160	40	252,8	318,8	2600	3600	3,4	37	31	3	2,5	1	31	0,35	1,7	0,9
31315	75	160	40	240	245	3200	4300	3,5	37	26	3	2,5	1	48	0,83	0,7	0,4
32315	75	160	58	345	480	2200	3000	5,3	55	45	3	2,5	1	38	0,35	1,7	0,9
32016	80	125	29	141	220	2600	3600	1,25	29	22	1,5	1,5	0,6	27	0,43	1,4	0,8
33016	80	125	36	173	284	2800	3700	1,6									
33116	80	130	37	179	280	3600	4800	1,9	37	29	2	1,5					
30216	80	140	28,25	167,7	212,9	2400	3400	1,59	26	22	2,5	2	0,6	28	0,43	1,4	0,8
32216	80	140	35,25	198,1	279	2400	3400	2	33	28	2,5	2	0,6	30	0,43	1,4	0,8
33216	80	140	46	250	365	2500	3400	2,92									
30316	80	170	42,5	278,8	352,5	2000	3000	4	39	33	3	2,5	1	33	0,35	1,7	0,9
31316	80	170	42,5	260	265	3000	4000	4,05	39	27	3	2,5	1	52	0,83	0,7	0,4
32316	80	170	61,5	387,9	543,1	2100	2800	6,1	58	48	3	2,5	1	41	0,35	1,7	0,9
32017	85	130	29	142	224	2600	3500	1,35	29	22	1,5	1,5	0,6	28	0,44	1,4	0,8
33017	85	130	36	176	296	2600	3500	1,7									
33117	85	140	41	220	340	3400	4500	2,45									
30217	85	150	30,5	177,6	236,8	2200	3200	2	28	24	2,5	2	0,6	30	0,43	1,4	0,8
32217	85	150	38,5	227	324	2200	3200	2,7	36	30	2,5	2	0,6	33	0,43	1,4	0,8
30317	85	180	44,5	305	388	2100	2900	4,96	41	34	4	3	1	35	0,35	1,7	0,9
31317	85	180	44,5	242	285	2600	3800	4,6	41	28	4	3					
32317	85	180	63,5	421	592	1900	2700	7,1	60	49	4	3	1	42	0,35	1,7	0,9
32018	90	140	32	168	270	2500	3300	1,79	32	24	2	1,5	0,6	30	0,43	1,4	0,8
33018	90	140	39	215	360	2500	3300	2,18									
33118	90	150	45	251	390	3000	4300	3,1	45	35	2,5	2		35	0,4	1,5	0,8
32218	90	160	42,5	270	396	2000	3000	3,4	40	34	2,5	2	0,6	36	0,43	1,4	0,8
30318	90	190	46,5	342	441	2000	2700	5,8	43	36	4	3	1	36	0,35	1,7	0,9
31318	90	190	46,5	264	315	2400	3400	5,9	43	30	4	3	1	57	0,83	0,7	0,4
32318 A	90	190	67,5	468	625	2000	2700	8,79	64	53	4	3	1,5	46,2	0,35	1,74	0,96
32019	95	145	32	171	280	2300	3100	1,83	32	24	2	1,5	0,6	31	0,44	1,4	0,8
33019	95	145	39	219	375	2300	3100	2,27	39	32,5	2	1,5	0,6	27,6	0,28	2,16	0,4
30219	95	170	34,5	227	309	2100	2800	3,04	32	34,2	3	2,5	1,2	27	0,43	1,4	0,8
32219	95	170	45,5	303	448	1900	2800	4,3	43	37	3	2,5	1	39	0,43	1,4	0,8
30319	95	200	49,5	369	478	1900	2500	6,8	45	38	4	3	1	39	0,35	1,7	0,9
31319	95	200	49,5	292	355	2400	3400	3,95									
32319	95	200	71,5	516	737	1700	2300	10,1	67	55	4	3	1	47	0,35	1,7	0,9
32020	100	150	32	170	280	2200	3000	1,91	32	24	2	1,5	0,6	32	0,46	1,3	0,7
33020	100	150	39	224	390	2200	3000	2,37	39	32,5	0,5	1,5					
33120	100	165	52	325	607	2800	4100	5,33									
30220	100	180	37	254	350	2000	2700	3,72	34	29	3	2,5	1	35	0,43	1,4	0,8
32220	100	180	49	341	512	1800	2600	5,1	46	39	3	2,5	1	41	0,43	1,4	0,8
30320	100	215	51,5	406	526	1800	2400	8,22	47	39	4	3	1	40	0,35	1,7	0,9
31320	100	215	56,5	430	465	2400	3000										
32320	100	215	77,5	600	872	1600	2100	13,01	73	60	4	3	1	53	0,35	1,7	0,9

Index other bore sizes

BEARING STEEL 100Cr6



Details part number:  
- Suffix A:  
increased loadcapacity





Deep Groove Ball Bearing	Self-Aligning Ball Bearing	Angular Contact Ball Bearing	
Cylindrical Roller Bearing	<b>Tapered Roller Bearing</b>	Spherical Roller Bearing	
Thrust Ball Bearing	Spherical Roller Thrust Bearing	Accessories Adapter & Withdrawal Sleeve	Technical & Related Information

# 40100d

## Tapered Roller Bearing

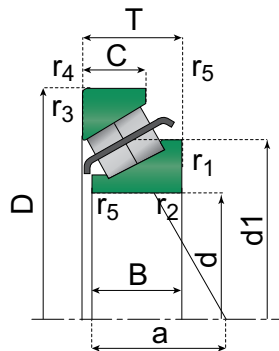

Click here for Technical & Related Information

Part number	Principal dimensions			Load ratings		Speed limits		Weight	B	C	Dimensions			Calculation factors			
	Bore	Outer	Width	Dynamic	Static	Grease	Oil				r1/r2	r3/r4	r5	a	e	Y	Yo
	d	D	T	C	Co	rpm					mm			mm			
	mm			kN		1 min <sup>-1</sup>		Kg									
32021	105	160	35	201	335	2100	2800	2,42	35	26	2,5	2	0,6	34	0,44	1,4	0,8
33021	105	160	43	245	420	2100	2800	3	43	34	2,5	2					
33121	105	175	56	360	607	2600	3800	5,33									
30221	105	190	39	285	399	1900	2500	4,38	36	30	3	2,5	1	37	0,43	1,4	0,8
32221	105	190	53	381	579	1700	2500	6,2	50	43	3	2,5	1	44	0,43	1,4	0,8
30321	105	225	53,5	433	562	1700	2300	9,38									
32321	105	225	81,5	660	915	1500	2000	15	77	63	4	4	3	54	0,35	1,7	0,96
32022	110	170	38	245,7	403,4	2100	2800	3,02	38	36,6	2,5	2	1	36,6	0,43	1,4	0,8
33022	110	170	47	288	500	2000	2700	3,8									
33122	110	180	56	369	630	2600	3400	5,55									
30222	110	200	41	315	444	1800	2400	5,21	38	32	3	2,5	1	39	0,43	1,4	0,8
32222	110	200	56	432	666	1700	2400	7,1	53	46	3	2,5	1	46	0,43	1,4	0,8
30322	110	240	54,5	473	612	1600	2200	11	50	42	4	3	1	43	0,35	1,7	0,9
31322	110	240	63	457	585	1900	2800	12									
32322	110	240	84,5	627	830	1400	1900	17	80	65	4	3	1	55	0,35	1,7	0,9
32024	120	180	38	320	545	1800	2500	4,96	38	29	2,5	2	0,6	39	0,46	1,3	0,7
33024	120	180	48	292	540	2600	3400	4,2									
33124	120	200	62	462	785	2400	3200	7,73									
30224	120	215	43,5	337	483	1700	2200	6,2	40	34	3	2,5	1	43	0,43	1,4	0,8
32224	120	215	61,5	468	695	1600	2200	9,15	58	50	3	2,5	1	51	0,43	1,4	0,8
30324	120	260	59,5	561	710	1500	2000	14	55	46	4	3	1	47	0,35	1,7	0,9
31324	120	260	68	539	695	1700	2400	15,5	62	42							
32324	120	260	90,5	845	1190	1300	1800	22,4	86	69	4	3	1	60	0,35	1,7	0,96
32026 X	130	200	45	326	550	1700	2200	4,93	45	34	2,5	2	1	43,3	0,43	1,38	0,76
30226	130	230	43,75	366	521	1500	2000	6,94	40	34	4	3	1	45	0,43	1,4	0,8
32226	130	230	67,75	550	830	1500	2000	11,5	64	54	4	3	1	56	0,43	1,4	0,8
30326	130	280	63,75	627	800	1300	1800	17	58	49	5	4	1,5	51	0,35	1,7	0,9
31326	130	280	72	605	780	1600	2400	18,5	66	44	5	4	1,5	87	0,83	0,7	0,4
32326	130	280	98,75	858	1180	1100	1600	30,5	93	78	5	4	1,5	66	0,35	1,7	0,9
32028	140	210	45	330	580	1600	2100	5,28	45	34	2,5	2	0,6	46	0,46	1,3	0,7
30228 A	140	250	45,75	405	540	1400	1900	8,8	42	36	4	3	1	47	0,44	1,4	0,76
32228	140	250	71,75	644	1000	1400	1900	14,5	68	58	4	3	1	60	0,43	1,4	0,8
30328 A	140	300	67,75	670	945	1200	1700	21,2	62	53	5	5		0,35	1,7	0,96	
32328 A	140	300	107,75	1090	1630	1200	1700	35,8	102	85	5	5	4	74	0,37	1,6	0,9
32030	150	225	48	370	655	1400	1900	6,37	48	36	3	2,5	1	49	0,46	1,3	0,7
33030	150	225	59	457	865	2000	2600	8,15									
30230	150	270	49	451	646	1300	1700	10,8	45	38	4	3	1	50	0,43	1,4	0,8
32230	150	270	77	737	1140	1200	1700	17,5	73	60	4	3	1	64	0,43	1,4	0,8
30330	150	320	72	825	1060	1100	1600	28,5									
32330	150	320	114	1170	1660	950	1400	46									
32032	160	240	51	435	790	1400	1800	7,8	51	38	3	2,5	1	52	0,46	1,3	0,7
30232	160	290	52	512	739	1200	1600	13,3	48	40	4	3	1	54	0,43	1,4	0,8
32232	160	290	84	880	1400	1100	1600	25,5	80	67	4	3	1	70	0,43	1,4	0,8
30332	160	340	75	913	1180	1000	1500	29									
32332 A	160	340	121	1400	2230	1000	1500	51,7	114	95	5	4		81	0,35	1,7	0,96
32034	170	260	57	500	895	1300	1700	10,5	57	43	3	2,5	1	56	0,44	1,4	0,8
30234	170	310	57	591	866	1100	1500	16,6	52	43	5	4	1,5	58	0,43	1,4	0,8
32234	170	310	91	1010	1630	1000	1500	28,5	86	71	5	4	1,5	75	0,43	1,4	0,8
30334	170	360	80	1020	1340	950	1400	35									

Index other bore sizes

BEARING STEEL 100Cr6



Details part number:  
- Suffix A:  
increased loadcapacity



Deep Groove Ball Bearing	Self-Aligning Ball Bearing	Angular Contact Ball Bearing	
Cylindrical Roller Bearing	<b>Tapered Roller Bearing</b>	Spherical Roller Bearing	
Thrust Ball Bearing	Spherical Roller Thrust Bearing	Accessories Adapter & Withdrawal Sleeve	Technical & Related Information

### 40100e

## Tapered Roller Bearing

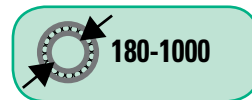
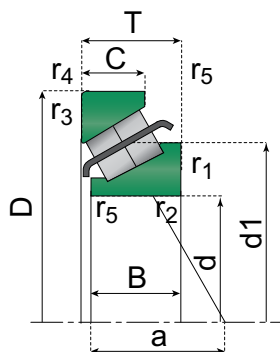

Click here for Technical & Related Information

Part number	Principal dimensions			Load ratings		Speed limits		Weight	B	C	Dimensions			Calculation factors			
	Bore	Outer	Width	Dynamic	Static	Grease	Oil				r1/r2	r3/r4	r5	a	e	Y	Yo
	d	D	T	C	Co	rpm					mm			mm			
	mm			kN		1 min <sup>-1</sup>		Kg									
32036	180	280	64	655	1210	1100	1500	14,5	64	48	3	2,5	1	59	0,43	1,4	0,8
30236	180	320	57	610	912	1100	1400	17,3	52	43	5	4	1,5	61	0,46	1,3	0,7
32236 A	180	320	91	1020	1670	950	1400	32,3	86	71	5	5	4	78	0,45	1,3	0,73
32938	190	260	45	341	707	1100	1600	6,52	42	36	2,5	2	2	49	0,38	1,6	0,86
32038	190	290	64	655	1210	1100	1500	15,1	64	48	3	2,5	1	62	0,44	1,4	0,8
30238	190	340	60	715	1000	1000	1300	20,8									
32238	190	340	97	1000	1670	1000	1300	33,3	92	75	5	4	1,5	81	0,43	1,4	0,8
32940	200	280	51	455	935	1000	1500	9,5	51	39	3	3	2,5	54	0,39	1,5	0,84
32040	200	310	70	782	1470	1100	1470	19,3	70	53	3	2,5	1	66	0,43	1,4	0,8
30240	200	360	64	780	1100	900	1300	25,4	58	48	5	5	4	70	0,44	1,4	0,76
32240	200	360	104	1350	2144	900	1300	42,6	98	82	5	5	4	84	0,41	1,5	0,81
32944	220	300	51	471	978	1000	1400	10	48	41	3	2,5	1	56,1	0,37	1,6	0,88
32044	220	340	76	909	1690	960	1690	25	76	57	4	3	1	72	0,43	1,4	0,8
30244	220	400	72	975	1370	900	1300	36,8	65	54	5	5	4	77	0,42	1,4	0,79
32244	220	400	114	1610	2770	900	1300	62,7	108	50	5	5	4	96	0,44	1,4	0,76
32948	240	320	51	520	1065	850	1200	11,5	51	39	3	3	2,5	64	0,46	1,3	0,7
32048	240	360	76	930	1760	870	1200	27,5	76	57	4	3	1	78	0,46	1,3	0,7
32248	240	440	127	1900	3300	700	950	82,5	120	100	5	5	4	105	0,43	1,4	0,8
32952	260	360	63,5	700	1470	800	1100	19,2	60	52	3	3	2,5	60	0,3	2	1,09
32052	260	400	87	912	1835	800	1100	40	87	65	5	4	1,5	84	0,43	1,4	0,8
32252	260	480	137	2160	3650	670	900	105	130	105	6	6	5	113	0,43	1,4	0,77
30352	260	540	114	2015	2730	670	900	113	102	85	6	6	6	92	0,32	1,9	1,04
32956	280	380	63,5	746	1579	800	1100	19,7	60	52	3	3	2,5	64	0,32	1,9	1,03
32056	280	420	87	1194	1840	750	1000	39,6	87	65	5	5	4	83	0,37	1,6	0,89
32960	300	420	76	1019	2200	700	950	30,2	72	62	4	4	3	67	0,28	2,1	1,17
32060	300	460	100	1516	2740	670	900	56,6	100	74	5	5	4	97	0,43	1,4	0,8
30660	300	540	149	2680	4700	600	800	142	140	115	6	6	5	126	0,43	1,4	0,8
32964	320	440	76	1046	2317	650	900	34,5	76	57	4	4	3	84	0,43	1,4	0,8
32064	320	480	100	1500	2940	630	850	62,7	100	74	5	5	4	104	0,46	1,3	0,72
30664	320	620	141	2780	4600	520	680	183	125	107	7,5	7,5	7,5	154	0,6	1	0,6
32968	340	460	76	1000	2350	500	830	36,5	76	57	4	4	3	90	0,44	1,35	0,8
32972	360	480	76	970	2220	500	630	38,5	76	57	4	4	4	97	0,46	1,3	0,72
30672	360	680	165	3620	6250	480	600	262	150	125	7,5	7,5	7,5	172	0,6	1	0,6
30680	400	750	130	2660	4180	320	430	222	115	77	6	6	6	189	0,7	0,86	0,47
30692	460	860	210	5590	10100	350	470	512	190	160	7,5	7,5	7,5	218	0,57	1,05	0,6
30696	480	950	240	6980	12500	310	420	761	225	174	9,5	9,5	9,5	230	0,54	1,1	0,6
306/560	560	1080	265	8910	15700	180	270	1063	235	208	9,5	9,5	9,5	241	0,43	1,4	0,8
329/630	630	850	132	3080	7150	360	450	200	132	95	6	6	6	168	0,46	1,3	0,72
306/630	630	920	134	3410	7100	320	430	286	128	94	7,5	7,5	7,5	166	0,43	1,4	0,78
306/680	680	1000	190	5580	12500	250	350	486	188	140	6	6	6	200	0,43	1,4	0,8
319/710	710	950	114	2860	6900	260	360	210	106	80	6	6	6	175	0,46	1,3	0,72
306/1000	1000	1420	210	8100	18000	160	230	966	195	150	7,5	7,5	7,5	278	0,46	1,3	0,72

Index other bore sizes

BEARING STEEL 100Cr6

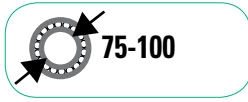

Details part number:  
- Suffix **A**:  
increased loadcapacity



Deep Groove Ball Bearing	Self-Aligning Ball Bearing	Angular Contact Ball Bearing	
Cylindrical Roller Bearing	Tapered Roller Bearing	<b>Spherical Roller Bearing</b>	
Thrust Ball Bearing	Spherical Roller Thrust Bearing	Accessories Adapter & Withdrawal Sleeve	Technical & Related Information

# 45010a

## Spherical Roller Bearing

### Introduction



Click here for  
Technical & Related  
Information

Spherical roller bearings are designed to sustain heavy loads, shaft misalignment and deflection. They contain two symmetrical or asymmetrical rows of barrel-shaped rollers, which align themselves in the outer race sphered track. They are, therefore, able to carry very heavy radial loads and axial loads in either direction.

Roller guidance is achieved by the fixed flanges on the inner ring for the CA, GMEX, MB, VS and MA - design or a floating ring for the C design. For further information, see roller guidance design on next page.

#### Misalignment

The table below gives figures for permitted misalignment in the different bearing series. Dimensions in accordance with ISO 15:2011



Bearing series	Angular misalignment degrees
213	1°
222	1.5°
223	2°
230	1.5°
231	1.5°
232	2.5°
239	1.5°
240	2°
241	2.5°

GMEX meet the higher exigency of the market. GMEX bearings are produced with higher grade steel, enhanced heat treatment process, higher machining accuracy and better surface roughness. These improvements are resulting in bearings that run with less noise and less vibrations and have a improved energy efficiency.

C 2RS type is a sealed spherical roller bearing with a steel cage C and 2 NBR seals. High temperature seals 2VS are available as well. Sealed bearings are filled with lithium based grease. Due to the seal, misalignment is reduced. As well for some types the bearing with differs from the standard width.

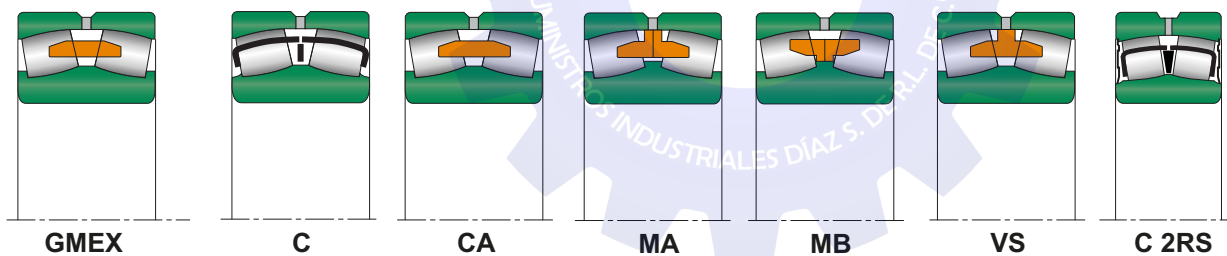

- GMEX** : 1 piece brass cage, roller guided between 2 inner ring flanges. Cage is guided on the rollers. Assymetrical roller position.
- C** : 2 pressed sheet steel cages, roller guided on a floating rings.
- CA** : 1 piece brass cage, roller guided between 2 inner ring flanges. Cage is guided on the rollers. Assymetrical roller position.
- MB** : 2 piece brass cage, roller guided between 2 inner ring flanges and one central rib. Cage is guided on the inner ring.
- VS C4 F80** : 1 piece brass cage, roller guided between 2 inner ring flanges. Cage is guided on the outer ring.
- MA C4 F80** : 2 piece brass cage, roller guided between 2 inner ring flanges and one central rib. Cage is guided on the outer ring.
- C 2RS** : Steel cage with 2 NBR seals

Spherical roller bearings are manufactured with tapered bore-K(1:12) and K30 (1:30) with lubrication groove and 3 lubrication holes on the outside diameter W33. All Rollway sphericals have the W33 feature.

#### Tolerances

Spherical roller bearings with cylindrical and tapered bore are generally manufactured to "PO" precision class.

#### Radial Clearance

Spherical roller bearings with cylindrical and tapered bore are generally manufactured to normal (CN), C2, C3, C4 and C5 clearances.

#### Heat Treatment

Spherical roller bearings with outside diameter D>240mm of all series given in this catalog can be used to an operating temperature of +150°C (+302°F). Small size bearings operate normally at temperatures up to +120°C (+248°F).







Deep Groove Ball Bearing	Self-Aligning Ball Bearing	Angular Contact Ball Bearing	
Cylindrical Roller Bearing	Tapered Roller Bearing	<b>Spherical Roller Bearing</b>	
Thrust Ball Bearing	Spherical Roller Thrust Bearing	Accessories Adapter & Withdrawal Sleeve	Technical & Related Information

# 4 5 1 0 0 b

## Spherical Roller Bearing



Click here for  
Technical & Related  
Information

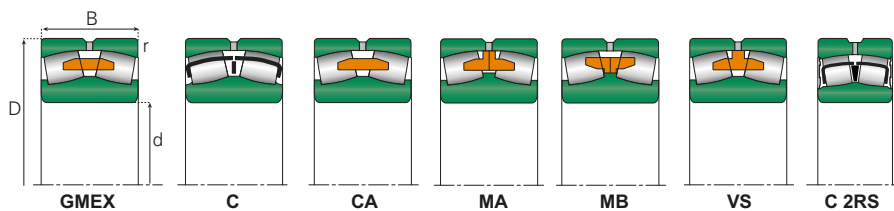

Part number	Principal dimensions			Basic load ratings		Speed limits		Weight	Radius	Calculation factors			
	Bore	Outer	Width	Dynamic	Static	Grease	Oil			rs min	e	Y1	Y2
	d	D	B	C	Co	rpm		Kg	mm				
22212 MB	60	110	28	137	164	3200	4100	1,19	1,5	0,27	2,50	3,70	2,40
22212 CA	60	110	28	127	154	3700	4900	1,20	1,5	0,25	2,71	4,04	2,65
22212 GMEX	60	110	28	133,4	154	4760	6375	1,50	1,2	0,24	2,78	4,13	2,71
22212 C	60	110	28	145	175	3400	4500	1,16	1,5	0,29	2,33	3,47	2,40
21312 CA	60	130	31	165	175	2900	3800	1,99	2,1	0,26	2,64	3,93	2,58
21312 GMEX	60	130	31	178,5	190	4080	5355	2,10	2,1	0,24	2,76	4,11	2,70
21312 C	60	130	31	150	180	3000	4000	1,95	2,1	0,24	2,81	4,19	2,80
22312 GMEX	60	130	46	288,8	316	3400	4500	2,93	2,1	0,37	1,85	2,75	1,76
22312 CA	60	130	46	236	273	2700	3600	3,01	2,1	0,38	1,78	2,65	1,74
22312 VS C4 F80	60	130	46	262	313	3800	4400	2,94	2,1	0,36	1,90	2,80	1,80
22312 C	60	130	46	270	320	2800	3800	2,95	2,1	0,41	1,65	2,45	1,70
22312 MB	60	130	46	260	310	2600	3400	2,98	2,1	0,43	1,57	2,34	1,60
22312 MA C4 F80	60	130	46	380	310	2600	3400	2,98	2,1	0,43	1,57	2,34	1,60
22312 C 2RS	60	130	46	243	284	3800	4400	2,77	2,1	0,36	1,90	2,80	1,80
22213 CA	65	120	31	151	188	3400	4600	1,61	1,5	0,27	2,49	3,71	2,43
22213 GMEX	65	120	31	176,4	205	4250	5950	1,50	1,6	0,25	2,69	4,00	2,63
22213 C	65	120	31	180	220	3000	4000	1,45	1,5	0,29	2,33	3,47	2,40
22213 MB	65	120	31	165	200	2800	3600	1,73	1,5	0,29	2,33	3,47	2,40
21313 GMEX	65	140	33	203,7	214	3655	5100	2,10	2,5	0,24	2,85	4,25	2,79
21313 CA	65	140	33	186	197	2900	3800	2,45	2,1	0,25	2,69	4,00	2,63
21313 C	65	140	33	220	290	2800	3800	2,45	2,1	0,24	2,81	4,19	2,80
22313 CA	65	140	48	251	291	2500	3400	3,53	2,1	0,35	1,92	2,86	1,88
22313 GMEX	65	140	48	304,5	345	3230	4250	2,10	3,6	0,35	1,95	2,90	1,91
22313 VS C4 F80	65	140	48	285	330	3600	4200	3,67	2,1	0,35	1,90	2,90	1,90
22313 MA C4 F80	65	140	48	280	330	2400	3200	3,51	2,1	0,41	1,65	2,45	1,70
22313 MB	65	140	48	280	330	2400	3200	3,51	2,1	0,41	1,65	2,45	1,70
22313 C	65	140	48	305	360	2800	3600	3,55	2,1	0,41	1,65	2,45	1,70
22313 MA C4 F80	65	140	48	280	330	2400	3200	3,56	2,1	0,41	1,65	2,45	1,70
22313 C 2RS	65	140	48	251	291	3600	4200	3,78	2,1	0,35	1,90	2,90	1,90
22214 GMEX	70	125	31	181,7	215	4250	5695	1,50	1,7	0,23	2,90	4,31	2,83
22214 CA	70	125	31	155	193	3200	4300	1,68	1,5	0,24	2,83	4,21	2,77
22214 C	70	125	31	180	225	2800	3800	1,55	1,5	0,26	2,60	3,87	2,60
21314 GMEX	70	150	35	224,7	240	3400	4760	2,10	3,0	0,23	2,88	4,29	2,82
21314 GMEX	70	150	35	237,4	278,5	3400	4760	3,19	3,0	0,23	2,88	4,29	2,82
21314 CA	70	150	35	206	223	2900	3800	2,98	2,1	0,25	2,74	4,08	2,68
21314 C	70	150	35	250	310	2600	3400	3,10	2,1	0,24	2,81	4,19	2,90
22314 CA	70	150	51	300	362	2400	3100	4,37	2,1	0,35	1,95	2,91	1,91
22314 GMEX	70	150	51	353,9	417	2890	3825	2,10	4,4	0,34	1,99	2,96	1,94
22314 VS C4 F80	70	150	51	340	420	3600	4000	4,39	2,1	0,34	2,00	2,90	1,90
22314 MB	70	150	51	340	420	2200	2800	4,30	2,1	0,38	1,78	2,64	1,80
22314 C	70	150	51	375	455	2400	3200	4,30	2,1	0,41	1,65	2,45	1,70
22314 C	70	150	51	375	455	2400	3200	4,35	2,1	0,41	1,65	2,45	1,70
22314 C 2RS	70	150	51	300	362	3600	4000	4,37	2,1	0,34	2,00	2,90	1,90
22215 GMEX	75	130	31	186,9	227	4080	5355	1,50	1,7	0,22	3,04	4,53	2,97
22215 CA	75	130	31	161	204	3100	4100	1,77	1,5	0,25	2,74	4,08	2,68
22215 MB	75	130	31	175	230	2600	3400	1,72	1,5	0,25	2,70	4,02	2,70
22215 C	75	130	31	190	250	2800	3800	1,60	1,5	0,25	2,70	4,02	2,70
22215 C	75	130	31	190	250	2800	3800	1,65	1,5	0,25	2,70	4,02	2,70
21315 GMEX	75	160	37	263,6	283	3400	4760	2,10	3,6	0,23	2,90	4,31	2,83
21315 CA	75	160	37	249	270	2900	3800	3,63	2,1	0,24	2,84	4,23	2,78
21315 C	75	160	37	280	360	2400	3200	3,55	2,1	0,24	2,81	4,19	2,90
22315 GMEX	75	160	55	374,9	447	2200	3000	2,10	5,5	0,38	1,78	2,65	1,74
22315 CA	75	160	55	357	447	2200	2900	5,50	2,1	0,36	1,87	2,79	1,83
22315 VS C4 F80	75	160	55	380	475	3000	3600	5,35	2,1	0,35	2,00	2,90	1,90
22315 C	75	160	55	415	520	2200	3000	5,25	2,1	0,41	1,65	2,45	1,70
22315 MA C4 F80	75	160	55	351	437	2200	2800	5,26	2,1	0,41	1,65	2,45	1,70
22315 MB	75	160	55	351	437	2200	2800	5,26	2,1	0,41	1,65	2,45	1,70
22315 C 2RS	75	160	55	351	437	3000	3600	5,64	2,1	0,35	2,00	2,90	1,90

Index other bore sizes  
BEARING STEEL 100Cr6





Deep Groove Ball Bearing	Self-Aligning Ball Bearing	Angular Contact Ball Bearing	
Cylindrical Roller Bearing	Tapered Roller Bearing	<b>Spherical Roller Bearing</b>	
Thrust Ball Bearing	Spherical Roller Thrust Bearing	Accessories Adapter & Withdrawal Sleeve	Technical & Related Information

# 4 5 1 0 0 c

## Spherical Roller Bearing

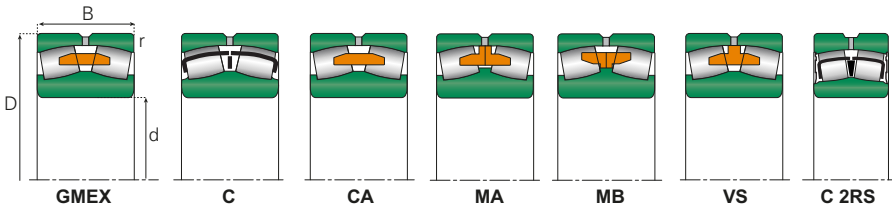

Click here for Technical & Related Information

Part number	Principal dimensions			Basic load ratings		Speed limits		Weight	Radius	Calculation factors			
	Bore	Outer	Width	Dynamic	Static	Grease	Oil			rs min	e	Y1	Y2
	d	D	B	C	Co	rpm		Kg	mm				
mm			kN		1 min <sup>-1</sup>								
22216 CA	80	140	33	174	225	2900	3800	2,20	2,0	0,22	3,01	4,48	2,94
22216 GMEX	80	140	33	201,6	244	3655	5100	2,00	2,1	0,22	3,07	4,57	3,00
22216 MB	80	140	33	195	250	2200	3000	2,15	2,0	0,25	2,70	4,02	2,70
22216 CA	80	140	33	165	225	3200	4000	2,08	2,0	0,24	2,80	4,20	2,80
22216 C	80	140	33	210	275	2600	3400	2,05	2,0	0,26	2,60	3,87	2,60
21316 GMEX	80	170	39	285,6	310	3230	4505	2,10	4,3	0,23	2,92	4,35	2,86
21316 CA	80	170	39	272	306	2900	3800	4,29	2,1	0,24	2,84	4,23	2,78
21316 C	80	170	39	310	400	2200	3000	4,25	2,1	0,24	2,81	4,19	2,90
22316 CA	80	170	58	395	496	2100	2800	6,54	2,1	0,36	1,87	2,79	1,83
22316 GMEX	80	170	58	453,2	535	2550	3400	2,10	6,6	0,35	1,92	2,86	1,88
22316 CA	80	170	58	380	495	2000	2800	7,47	2,1	0,34	1,99	2,96	1,94
22316 VS C4 F80	80	170	58	420	535	2800	3400	6,41	2,1	0,34	2,00	2,90	1,90
22316 MA C4 F80	80	170	58	410	500	1800	2400	6,10	2,1	0,26	2,60	3,87	2,60
22316 MB	80	170	58	410	500	1800	2400	6,20	2,1	0,26	2,60	3,87	2,60
22316 C	80	170	58	450	550	2000	2600	6,29	2,1	0,38	1,78	2,64	1,80
22316 C 2RS	80	170	58	395	496	2800	3400	6,54	2,1	0,34	2,00	2,90	1,90
22217 CA	85	150	36	216	277	2700	3600	2,73	2,0	0,23	2,95	4,40	2,89
22217 GMEX	85	150	36	247,8	308	3400	4760	2,00	2,7	0,22	3,01	4,48	2,94
22217 CA	85	150	36	193	254	3000	3800	2,69	2,0	0,24	2,80	4,20	2,80
22217 C	85	150	36	250	325	2400	3200	2,55	2,0	0,26	2,60	3,87	2,60
22217 MB	85	150	36	230	295	2200	2800	2,78	2,0	0,26	2,60	3,87	2,60
21317 GMEX	85	180	41	309	356	3230	4505	3,00	5,1	0,23	2,96	4,41	2,90
21317 CA	85	180	41	294	360	2000	2800	5,42	3,0	0,24	2,80	4,20	2,80
21317 C	85	180	41	350	450	2200	2800	5,10	3,0	0,24	2,81	4,19	2,90
22317 CA	85	180	60	431	539	2000	2600	7,42	3,0	0,34	2,01	3,00	1,97
22317 GMEX	85	180	60	478,8	543	2380	3230	7,14	3,0	0,34	1,99	2,96	1,94
22317 CA	85	180	60	391	505	1900	2600	8,19	3,0	0,34	1,99	2,96	1,94
22317 VS C4 F80	85	180	60	462	591	2500	3200	7,47	3,0	0,34	2,00	3,00	2,00
22317 MA C4 F80	85	180	60	460	570	1700	2200	7,20	3,0	0,38	1,78	2,64	1,80
22317 MB	85	180	60	460	570	1700	2200	7,25	3,0	0,38	1,78	2,64	1,80
22317 C	85	180	60	500	620	1800	2400	8,59	3,0	0,34	1,99	2,96	2,00
22317 GMEX	85	180	60	450	570,6	2500	3000	8,19	3,0	0,34	2,01	3,00	1,97
22317 C 2RS	85	180	60	431	539	2500	3200	7,40	3,0	0,34	2,00	3,00	2,00
24018 CA	90	140	50	229	386	1600	2200	3,25	1,5	0,32	2,09	3,11	2,04
24018 CA	90	140	50	233	390	2600	3400	3,25	1,5	0,33	2,00	3,00	2,00
22218 CA	90	160	40	252	332	2500	3300	3,47	2,0	0,23	2,90	4,31	2,83
22218 GMEX	90	160	40	294	369	3230	4505	2,00	3,5	0,24	2,87	4,27	2,80
22218 CA	90	160	40	252	188	2600	3400	3,40	2,0	0,25	2,70	4,00	2,60
22218 C	90	160	40	305	410	2200	3000	3,25	2,0	0,27	2,50	3,72	2,50
22218 MB	90	160	40	280	375	2200	2800	3,57	2,0	0,27	2,50	3,72	2,50
23218 GMEX	90	160	52	354,9	483	2380	3230	3,00	4,4	0,31	2,16	3,22	2,11
23218 CA	90	160	52,4	316	453	1600	2200	4,64	2,0	0,33	2,07	3,09	2,03
23218 CA	90	160	52,4	319	475	1900	2600	4,82	2,0	0,25	2,70	4,00	2,60
23218 MB	90	160	52,4	340	485	1500	2000	4,60	2,0	0,34	1,99	2,96	2,00
23218 GMEX	90	160	52,4	340,1	487,3	1800	2300	4,82	2,0	0,31	2,15	3,20	2,10
24218 CA	90	160	67	334	475	1900	2600	5,87	2,0	0,31	2,20	3,30	2,20
21318 GMEX	90	190	43	360,2	397	3060	4080	3,00	5,9	0,23	2,97	4,42	2,90
21318 C	90	190	43	385	510	2200	2800	5,80	3,0	0,24	2,81	4,19	2,90
22318 CA	90	190	64	472	600	1900	2500	8,87	3,0	0,35	1,92	2,86	1,88
22318 CA	90	190	64	462	625	1800	2400	11,5	3,0	0,34	1,99	2,96	1,94
22318 GMEX	90	190	64	506	656	2300	2700	8,33	3,0	0,34	2,00	2,97	1,95
22318 VS C4 F80	90	190	64	530	677	2600	3000	8,56	3,0	0,34	2,00	3,00	2,00
22318 C	90	190	64	570	730	1800	2400	8,60	3,0	0,38	1,78	2,64	1,80
22318 MA C4 F80	90	190	64	530	670	1700	2200	8,69	3,0	0,38	1,78	2,64	1,80
22318 MB	90	190	64	530	670	1700	2200	8,69	3,0	0,38	1,78	2,64	1,80
22318 GMEX	90	190	64	505,8	655,3	2300	2700	8,33	3,0	0,34	2,00	2,97	1,95
22318 C 2RS	90	190	64	497	659	2600	3000	8,63	3,0	0,34	2,00	3,00	2,00

Index other bore sizes  
BEARING STEEL 100Cr6





Deep Groove Ball Bearing	Self-Aligning Ball Bearing	Angular Contact Ball Bearing	
Cylindrical Roller Bearing	Tapered Roller Bearing	<b>Spherical Roller Bearing</b>	
Thrust Ball Bearing	Spherical Roller Thrust Bearing	Accessories Adapter & Withdrawal Sleeve	Technical & Related Information

# 4 5 1 0 0 d

## Spherical Roller Bearing



Click here for Technical & Related Information

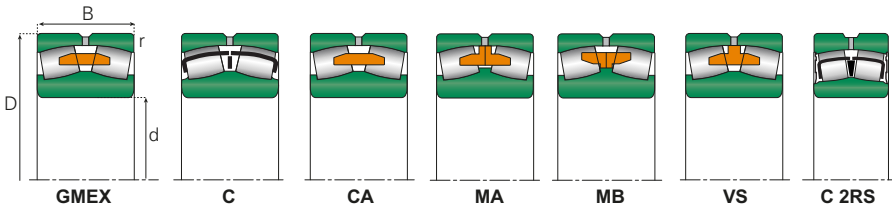

Part number	Principal dimensions			Basic load ratings		Speed limits		Weight	Radius	Calculation factors				
	Bore	Outer	Width	Dynamic	Static	Grease	Oil			rs min	e	Y1	Y2	Yo
	d	D	B	C	Co	rpm		Kg	mm					
mm			kN		1 min <sup>-1</sup>									
22219 CA	95	170	43	273	359	2400	3200	4,32	2,1	0,26	2,64	3,93	2,58	
22219 GMEX	95	170	43	329,7	414	3060	4080	2,10	4,2	0,24	2,81	4,18	2,75	
22219 CA	95	170	43	270	375	2400	3200	4,68	2,1	0,24	2,80	4,20	2,80	
22219 MB	95	170	43	310	415	2000	2600	4,00	2,1	0,27	2,50	3,72	2,50	
22219 MB	95	170	43	310	415	2000	2600	4,10	2,1	0,27	2,50	3,72	2,50	
22219 C	95	170	43	340	450	2200	2800	4,26	2,1	0,24	2,81	4,19	2,80	
21319 GMEX	95	200	45	402,2	460	2890	3825	3,00	6,9	0,22	3,04	4,52	2,97	
21319 MB	95	200	45	385	530	1800	2400	7,15	3,0	0,23	2,93	4,37	3,00	
21319 CA	95	200	45	420	580	2000	2600	7,43	3,0	0,23	2,93	4,37	3,00	
22319 CA	95	200	67	516	657	1800	2300	10,4	3,0	0,35	1,92	2,86	1,88	
22319 CA	95	200	67	512	685	1800	2400	10,5	3,0	0,34	1,99	2,96	1,94	
22319 VS C4 F80	95	200	67	568	744	2200	2800	10,3	3,0	0,34	2,00	3,00	2,00	
22319 MA C4 F80	95	200	67	570	740	1500	2000	10,0	3,0	0,41	1,65	2,45	1,70	
22319 MB	95	200	67	570	740	1500	2000	10,2	3,0	0,41	1,65	2,45	1,70	
22319 C	95	200	67	620	800	1700	2200	11,3	3,0	0,38	1,78	2,64	1,80	
22319 GMEX	95	200	67	555,1	721,7	2100	2500	10,5	3,0	0,34	2,00	2,99	1,96	
22319 C 2RS	95	200	67	531	705	2200	2800	9,97	3,0	0,34	2,00	3,00	2,00	
23020 CA	100	150	37	237	400	2400	3200	2,51	1,5	0,23	2,90	4,40	2,80	
23020 GMEX	100	150	37	218,8	349,7	2000	2600	2,51	1,5	0,22	3,07	4,56	3,00	
24020 CA	100	150	50	242	425	1500	2000	3,15	1,5	0,30	2,23	3,32	2,18	
24020 CA	100	150	50	271	445	2400	3200	3,18	1,5	0,30	2,25	3,35	2,20	
24020 GMEX	100	150	50	250,8	431,8	1800	2500	3,18	1,5	0,30	2,25	3,34	2,20	
23120 CA	100	165	52	326	490	1700	2200	4,39	2,0	0,31	2,21	3,29	2,16	
23120 GMEX	100	165	52	358	537	2550	3400	3,00	4,6	0,30	2,25	3,34	2,20	
23120 CA	100	165	52	316	510	2000	2800	4,42	2,0	0,23	2,90	4,40	2,80	
23120 MB	100	165	52	355	540	2000	2600	4,50	2,0	0,33	2,05	3,05	2,10	
23120 GMEX	100	165	52	343,7	525,9	1500	2000	4,42	2,0	0,29	2,30	3,42	2,25	
22220 CA	100	180	46	318	424	2200	3000	5,10	2,1	0,24	2,84	4,23	2,78	
22220 GMEX	100	180	46	379,1	475	2890	3825	2,10	5,1	0,24	2,80	4,18	2,74	
22220 CA	100	180	46	305	425	2200	3000	5,18	2,1	0,24	2,80	4,20	2,80	
22220 MB	100	180	46	340	455	2000	2600	4,80	2,1	0,29	2,33	3,47	2,40	
22220 MB	100	180	46	340	455	2000	2600	4,85	2,1	0,29	2,33	3,47	2,40	
22220 C	100	180	46	375	500	2200	2800	5,24	2,1	0,24	2,81	4,19	2,80	
23220 CA	100	180	60,3	405	589	1500	1900	6,81	2,1	0,33	2,03	3,02	1,98	
23220 CA	100	180	60,3	440	570	1700	2200	6,58	2,1	0,33	2,00	3,00	2,00	
23220 MB	100	180	60,3	455	660	1500	2000	6,70	2,1	0,34	1,99	2,96	2,00	
23220 C	100	180	60,3	495	720	1700	2200	7,34	2,1	0,34	1,99	2,96	2,00	
23220 GMEX	100	180	60,3	438	640,1	1600	2100	6,58	2,1	0,32	2,12	3,15	2,07	
21320 GMEX	100	215	47	429	498	2890	3825	3,00	8,4	0,22	3,06	4,56	2,99	
21320 MB	100	215	47	425	580	1700	2200	8,80	3,0	0,22	3,07	4,57	3,10	
21320 CA	100	215	47	382	446	1800	2400	9,07	3,0	0,22	3,07	4,57	3,10	
22320 CA	100	215	73	613	799	1600	2200	13,3	3,0	0,35	1,91	2,85	1,87	
22320 CA	100	215	73	594	815	1700	2200	13,8	3,0	0,35	1,90	2,90	1,80	
22320 VS C4 F80	100	215	73	670	880	2200	2600	13,2	3,0	0,34	2,00	2,90	1,90	
22320 MA C4 F80	100	215	73	670	880	1400	1800	12,7	3,0	0,41	1,65	2,45	1,70	
22320 MB	100	215	73	670	880	1400	1800	12,7	3,0	0,41	1,65	2,45	1,70	
22320 C	100	215	73	730	960	1500	2000	13,2	3,0	0,41	1,65	2,45	1,70	
22320 GMEX	100	215	73	644,7	851	1900	2200	13,8	3,0	0,34	1,97	2,93	1,93	
22320 C 2RS	100	215	73	497	659	2200	2600	13,3	3,0	0,36	2,00	2,90	1,90	
23121 CA	105	175	56	402	550	1900	2700	5,48	2,0	0,31	2,20	3,30	2,20	
23121 GMEX	105	175	56	405,4	587,5	1400	1800	5,48	2,0	0,30	2,26	3,37	2,21	

Index other bore sizes  
BEARING STEEL 100Cr6





Deep Groove Ball Bearing	Self-Aligning Ball Bearing	Angular Contact Ball Bearing	
Cylindrical Roller Bearing	Tapered Roller Bearing	<b>Spherical Roller Bearing</b>	
Thrust Ball Bearing	Spherical Roller Thrust Bearing	Accessories Adapter & Withdrawal Sleeve	Technical & Related Information

# 4 5 1 0 0 e

## Spherical Roller Bearing



Click here for Technical & Related Information

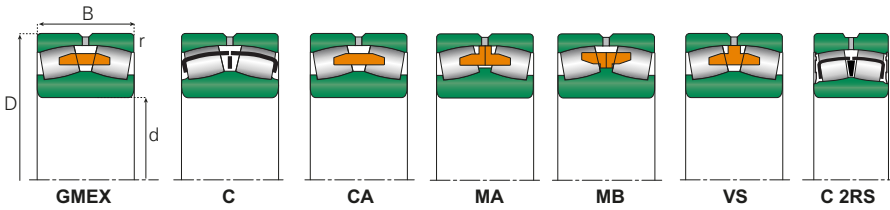

Part number	Principal dimensions			Basic load ratings		Speed limits		Weight	Radius	Calculation factors			
	Bore	Outer	Width	Dynamic	Static	Grease	Oil			rs min	e	Y1	Y2
	d	D	B	C	Co	rpm		Kg	mm				
23022 CA	110	170	45	304	489	1900	2500	3,79	2,0	0,25	2,67	3,97	2,61
23022 CA	110	170	45	278	460	2200	3000	3,54	2,0	0,25	2,70	4,00	2,60
23022 MB	110	170	45	295	485	2000	2600	3,75	2,0	0,26	2,60	3,87	2,60
23022 GMEX	110	170	45	284,9	461,7	1900	2500	3,54	2,0	0,24	2,84	4,23	2,78
23024 MB	110	180	46	335	560	1800	2400	4,20	2,0	0,24	2,81	4,19	2,80
23024 C	110	180	46	365	610	2000	2600	4,25	2,0	0,24	2,81	4,19	2,80
24022 CA	110	170	60	294	506	1300	1800	5,60	2,0	0,32	2,12	3,15	2,07
24022 CA	110	170	60	330	580	2100	2800	4,98	2,0	0,32	2,09	3,11	2,04
24022 GMEX	110	170	60	367,8	629,4	1700	2200	4,98	2,0	0,32	2,10	3,13	2,05
23122 CA	110	180	56	382	596	1500	2000	5,72	2,0	0,29	2,32	3,45	2,26
23122 CA	110	180	56	358	580	1900	2600	5,73	2,0	0,30	2,25	3,35	2,20
23122 MB	110	180	56	362	573	1800	2400	5,55	2,0	0,31	2,18	3,24	2,20
23122 C	110	180	56	450	700	2000	2600	6,26	2,0	0,31	2,18	3,24	2,20
23122 GMEX	110	180	56	389,5	607,7	1300	1700	5,73	2,0	0,29	2,32	3,45	2,26
24122 CA	110	180	69	462	758	1200	1500	6,85	2,0	0,37	1,84	2,74	1,80
24122 CA	110	180	69	468	750	1000	1400	6,92	2,0	0,35	1,90	2,90	1,80
24122 CA	110	180	69	550	900	1200	1600	6,85	2,0	0,41	1,65	2,45	1,70
24122 GMEX	110	180	69	462,6	746,4	1600	2000	6,85	2,0	0,35	1,90	2,83	1,86
22222 C	110	200	53	590	770	1800	2400	7,45	2,1	0,27	2,50	3,72	2,50
22222 CA	110	200	53	414	574	2000	2700	7,69	2,1	0,26	2,55	3,80	2,50
22222 CA	110	200	53	380	545	2000	2800	7,43	2,1	0,26	2,60	3,90	2,50
22222 GMEX	110	200	53	463,4	651,2	2200	3000	7,23	2,1	0,25	2,66	3,96	2,60
22222 MB	110	200	53	540	700	1700	2200	7,10	2,1	0,30	2,25	3,35	2,30
22222 GMEX	110	200	53	463,4	651,2	2200	3000	7,23	2,1	0,25	2,66	3,97	2,60
23222 CA	110	200	69,8	528	786	1300	1800	9,79	2,1	0,34	2,00	2,97	1,95
23222 GMEX	110	200	69,8	578	871	1870	2720	2,10	9,9	0,33	2,02	3,01	1,98
23222 CA	110	200	69,8	539	720	1600	2000	10,1	2,1	0,34	1,99	2,96	1,94
23222 MB	110	200	69,8	570	840	1200	1600	9,70	2,1	0,34	1,99	2,96	2,00
23222 C	110	200	69,8	538	739	1400	1800	10,8	2,1	0,34	1,99	2,96	2,00
23222 GMEX	110	200	69,8	541,6	811,2	1500	1800	10,1	2,1	0,34	2,01	3,00	1,97
21322 MB	110	240	50	510	690	1500	2000	12,0	3,0	0,21	3,21	4,79	3,20
22322 CA	110	240	80	724	915	1500	2000	18,3	3,0	0,35	1,91	2,85	1,87
22322 CA	110	240	80	693	955	1600	2000	18,9	3,0	0,31	2,20	3,30	2,20
22322 VS C4 F80	110	240	80	800	1060	1800	2200	18,0	3,0	0,35	2,00	2,90	1,90
22322 MA C4 F80	110	240	80	800	1060	1300	1700	17,7	3,0	0,38	1,78	2,64	1,80
22322 MB	110	240	80	800	1060	1300	1700	17,7	3,0	0,38	1,78	2,64	1,80
22322 C	110	240	80	870	1160	1400	1900	18,0	3,0	0,38	1,78	2,64	1,80
22322 GMEX	110	240	80	779,4	990,3	1800	2000	18,9	3,0	0,35	1,95	2,90	1,91
22322 C 2RS	110	240	80	545	832	1800	2200	17,4	3,0	0,35	2,00	3,00	2,00

[Index other bore sizes](#)

**BEARING STEEL 100Cr6**

- 25-55
- 60-75
- 80-90
- 95-105
- 110
- 120
- 130
- 140
- 150-260
- 280-1800



Deep Groove Ball Bearing	Self-Aligning Ball Bearing	Angular Contact Ball Bearing	
Cylindrical Roller Bearing	Tapered Roller Bearing	<b>Spherical Roller Bearing</b>	
Thrust Ball Bearing	Spherical Roller Thrust Bearing	Accessories Adapter & Withdrawal Sleeve	Technical & Related Information



# 4 | 5 | 1 | 0 | 0 | f

## Spherical Roller Bearing



Click here for  
Technical & Related  
Information

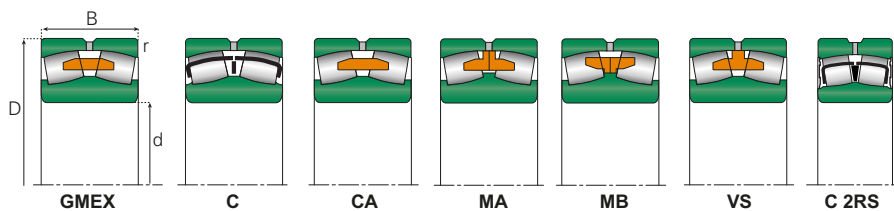

Part number	Principal dimensions			Basic load ratings		Speed limits		Weight Kg	Radius rs min mm	Calculation factors			
	Bore d	Outer D	Width B	Dynamic C	Static Co	Grease rpm	Oil rpm			e	Y1	Y2	Yo
	mm			kN		1 min <sup>-1</sup>				mm			
23024 CA	120	180	46	317	514	1700	2300	4,10	2,0	0,24	2,79	4,15	2,73
23024 CA	120	180	46	300	495	2000	2800	4,44	2,0	0,23	2,90	4,40	2,80
23024 GMEX	120	180	46	298,4	475,9	1700	2300	4,44	2,0	0,21	3,20	4,77	3,13
24024 CA	120	180	60	450	800	1500	2000	5,40	2,0	0,34	1,99	2,96	2,00
24024 CA	120	180	60	386	673	1200	1700	5,40	2,0	0,31	2,18	3,24	2,13
24024 CA	120	180	60	360	660	1600	2000	5,83	2,0	0,31	2,20	3,30	2,20
24024 MB	120	180	60	410	740	1460	1800	5,12	2,0	0,34	1,99	2,96	2,00
24024 GMEX	120	180	60	342,3	613,9	1500	2000	5,83	2,0	0,30	2,26	3,37	2,21
23124 CA	120	200	62	468	726	1400	1900	8,01	2,0	0,30	2,25	3,34	2,20
23124 CA	120	200	62	405	715	1800	2400	12,4	2,0	0,30	2,30	3,40	2,20
23124 MB	120	200	62	495	770	1700	2200	7,80	2,0	0,31	2,18	3,24	2,20
23124 GMEX	120	200	62	478,3	758,9	1250	1600	12,4	2,0	0,29	2,35	3,50	2,30
24124 CA	120	200	80	601	994	1100	1400	10,2	2,0	0,39	1,74	2,59	1,70
24124 CA	120	200	80	495	925	900	1200	10,6	2,0	0,30	2,30	3,40	2,20
24124 MB	120	200	80	630	1050	1000	1300	10,2	2,0	0,43	1,57	2,34	1,60
24124 GMEX	120	200	80	592,2	984,5	1400	1800	10,6	2,0	0,37	1,82	2,71	1,78
24124 CA	120	240	100	570	925	1500	1900	21,3	2,0	0,38	1,80	2,60	1,70
22224 CA	120	215	58	488	666	1900	2500	9,06	2,1	0,27	2,49	3,71	2,43
22224 CA	120	215	58	490	680	1900	2600	9,87	2,1	0,26	2,60	3,90	2,50
22224 GMEX	120	215	58	529,7	739,4	2100	2800	9,87	2,1	0,27	2,49	3,71	2,43
22224 C	120	215	58	560	800	1700	2200	8,70	2,1	0,30	2,25	3,35	2,30
22224 MB	120	215	58	510	740	1500	2000	9,04	2,1	0,30	2,25	3,35	2,30
22224 GMEX	120	215	58	529,7	739,4	2100	2800	9,87	2,1	0,27	2,49	3,71	2,43
23224 CA	120	215	76	592	904	1200	1600	12,1	2,1	0,34	1,98	2,94	1,93
23224 CA	120	215	76	615	940	1500	1900	12,1	2,1	0,35	1,90	2,90	1,80
23224 MB	120	215	76	575	880	1100	1500	12,0	2,1	0,38	1,78	2,64	1,80
23224 C	120	215	76	616	941	1300	1700	13,1	2,1	0,38	1,78	2,64	1,80
23224 GMEX	120	215	76	656,8	963	1300	1700	12,1	2,1	0,34	1,99	2,96	1,94
22324 CA	120	260	86	848	1130	1400	1800	23,4	3,0	0,34	1,96	2,92	1,92
22324 CA	120	260	86	840	1100	1400	1800	23,3	3,0	0,34	1,99	2,96	1,94
22324 VS C4 F80	120	260	86	930	1230	1700	2000	22,5	3,0	0,34	2,00	3,00	2,00
22324 MA C4 F80	120	260	86	930	1230	1100	1500	21,8	3,0	0,38	1,78	2,64	1,80
22324 MB	120	260	86	874,6	1196	1100	1500	22,0	3,0	0,38	1,78	2,64	1,80
22324 C	120	260	86	1010	1340	1300	1700	24,5	3,0	0,38	1,78	2,64	1,80
22324 GMEX	120	260	86	919,8	1187,1	1500	1900	23,3	3,0	0,34	2,01	3,00	1,97

Index other bore sizes

BEARING STEEL 100Cr6

- 25-55
- 60-75
- 80-90
- 95-105
- 110
- 120
- 130
- 140
- 150-260
- 280-1800





Deep Groove Ball Bearing	Self-Aligning Ball Bearing	Angular Contact Ball Bearing	
Cylindrical Roller Bearing	Tapered Roller Bearing	<b>Spherical Roller Bearing</b>	
Thrust Ball Bearing	Spherical Roller Thrust Bearing	Accessories Adapter & Withdrawal Sleeve	Technical & Related Information

# 4 5 1 0 0 h

## Spherical Roller Bearing



Click here for  
Technical & Related  
Information

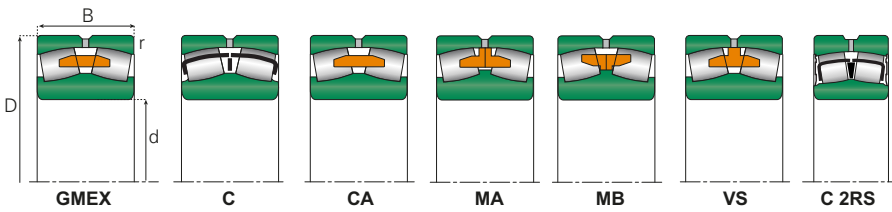

Part number	Principal dimensions			Basic load ratings		Speed limits		Weight	Radius	Calculation factors			
	Bore	Outer	Width	Dynamic	Static	Grease	Oil			rs min	e	Y1	Y2
	d	D	B	C	Co	rpm		Kg	mm				
mm			kN		1 min <sup>-1</sup>								
23026 CA	130	200	52	401	660	1600	2100	6,02	2,0	0,25	2,71	4,04	2,65
23026 CA	130	200	52	410	680	1900	2600	7,04	2,0	0,24	2,80	4,20	2,80
23026 C	130	200	52	450	730	1800	2400	4,59	2,0	0,24	2,81	4,19	2,80
23026 MB	130	200	52	410	670	1700	2200	6,10	2,0	0,24	2,81	4,19	2,80
23026 GMEX	130	200	52	408,8	681,7	1600	2100	7,04	2,0	0,23	2,87	4,28	2,81
24026 CA	130	200	69	484	841	1100	1500	8,16	2,0	0,33	2,07	3,09	2,03
24026 CA	130	200	69	470	810	1800	2400	7,76	2,0	0,32	2,09	3,11	2,04
24026 MB	130	200	69	530	900	1200	1600	7,95	2,0	0,36	1,88	2,79	1,90
24026 GMEX	130	200	69	463,9	827,4	1400	1800	7,76	2,0	0,31	2,16	3,22	2,12
23126 CA	130	210	64	512	798	1300	1800	8,75	2,0	0,28	2,40	3,58	2,35
23126 CA	130	210	64	473	790	1700	2200	10,7	2,0	0,28	2,40	3,50	2,50
23126 MB	130	210	64	540	860	1500	2000	8,55	2,0	0,31	2,18	3,24	2,20
23126 C	130	210	64	590	940	1700	2200	9,70	2,0	0,27	2,50	3,72	2,50
23126 GMEX	130	210	64	508	814,8	1200	1500	10,7	2,0	0,28	2,37	3,53	2,32
24126 CA	130	210	80	597	1020	980	1300	11,1	2,0	0,36	1,87	2,79	1,83
24126 CA	130	210	80	555	980	1700	2200	10,6	2,0	0,35	1,90	2,90	1,80
24126 MB	130	210	80	650	1100	900	1200	11,0	2,0	0,41	1,65	2,45	1,70
24126 GMEX	130	210	80	608,4	1042,7	1300	1700	10,6	2,0	0,35	1,93	2,87	1,88
22226 CA	130	230	64	613	880	1800	2300	11,2	3,0	0,28	2,43	3,61	2,37
22226 CA	130	230	64	539	805	1800	2400	12,4	3,0	0,27	2,50	3,70	2,50
22226 GMEX	130	230	64	608,5	890,2	2000	2600	11,3	3,0	0,26	2,55	3,80	2,50
22226 MB	130	230	64	600	865	1500	2000	11,2	3,0	0,31	2,18	3,24	2,20
22226 C	130	230	64	660	960	1700	2200	14,0	3,0	0,30	2,25	3,35	2,30
22226 GMEX	130	230	64	608,5	890,2	2000	2600	11,3	3,0	0,26	2,55	3,80	2,50
23226 GMEX	130	200	69	759	1172	1615	2210	14,5	3,0	0,33	2,04	3,04	2,00
23226 CA	130	230	80	670	1020	1100	1500	14,3	3,0	0,34	1,99	2,96	1,94
23226 CA	130	230	80	670	1020	1300	1700	14,3	3,0	0,34	1,99	2,96	1,94
23226 CA	130	230	80	737	1020	1300	1700	15,9	3,0	0,33	2,00	3,00	2,00
23226 MB	130	230	80	760	1170	1100	1500	14,0	3,0	0,34	1,99	2,96	2,00
23226 C	130	230	80	830	1270	1300	1700	15,8	3,0	0,34	1,99	2,96	2,00
23226 GMEX	130	230	80	769,9	1193,4	1200	1600	15,9	3,0	0,34	2,01	3,00	1,97
22326 CA	130	280	93	978	1320	1300	1700	28,5	4,0	0,35	1,95	2,90	1,91
22326 CA	130	280	93	924	1300	1300	1700	18,3	4,0	0,34	1,99	2,96	1,94
22326 VS C4 F80	130	280	93	1080	1465	1600	1900	27,6	4,0	0,33	2,00	3,00	2,00
22326 MA C4 F80	130	280	93	1080	1450	1100	1400	28,3	4,0	0,38	1,78	2,64	1,80
22326 MB	130	280	93	1080	1450	1100	1400	28,5	4,0	0,38	1,78	2,64	1,80
22326 C	130	280	93	1170	1580	1200	1600	28,5	4,0	0,38	1,78	2,64	1,80
22326 GMEX	130	280	93	1054	1432,7	1300	1800	18,3	4,0	0,33	2,02	3,01	1,98
22326 C 2RS	130	280	93	965	1341	1600	1900	28,0	4,0	0,34	2,00	3,00	2,00

Index other bore sizes  
BEARING STEEL 100Cr6

- 25-55
- 60-75
- 80-90
- 95-105
- 110
- 120
- 130
- 140
- 150-260
- 280-1800



Deep Groove Ball Bearing	Self-Aligning Ball Bearing	Angular Contact Ball Bearing	
Cylindrical Roller Bearing	Tapered Roller Bearing	<b>Spherical Roller Bearing</b>	
Thrust Ball Bearing	Spherical Roller Thrust Bearing	Accessories Adapter & Withdrawal Sleeve	Technical & Related Information

# 4 5 1 0 0 m

## Spherical Roller Bearing



Click here for  
Technical & Related  
Information

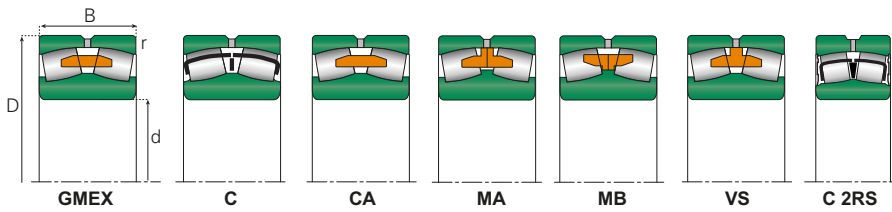

Part number	Principal dimensions			Basic load ratings		Speed limits		Weight	Radius	Calculation factors				
	Bore	Outer	Width	Dynamic	Static	Grease	Oil			e	Y1	Y2	Yo	
	d	D	B	C	Co	rpm		Kg	rs min	mm				
	mm			kN		1 min <sup>-1</sup>			mm					
23028 CA	140	210	53	415	689	1500	2000	6,43	2,0	0,24	2,81	4,19	2,75	
23028 CA	140	210	53	402	705	1800	2400	6,70	2,0	0,23	2,90	4,40	2,80	
23080 MB	140	210	53	435	750	1500	2000	6,55	2,0	0,24	2,81	4,19	2,80	
23028 C	140	210	53	475	820	1700	2200	7,20	2,0	0,24	2,81	4,19	2,80	
23028 GMEX	140	210	53	434,2	731,9	1500	1900	6,70	2,0	0,23	2,95	4,39	2,89	
24028 CA	140	210	69	495	865	1100	1400	8,42	2,0	0,31	2,21	3,29	2,16	
24028 CA	140	210	69	484	920	1800	2400	8,31	2,0	0,30	2,30	3,40	2,20	
24080 MB	140	210	69	550	990	1100	1500	8,45	2,0	0,33	2,05	3,05	2,10	
24028 GMEX	140	210	69	509	911	1300	1700	8,31	2,0	0,29	2,29	3,41	2,24	
23128 CA	140	225	68	546	876	1200	1600	10,7	2,1	0,28	2,39	3,56	2,34	
23128 GMEX	140	225	68	622,7	978	1870	2380	2,10	1,1	0,28	2,41	3,59	2,35	
23128 CA	140	225	68	539	935	1600	2000	10,9	2,1	0,29	2,30	3,50	2,40	
23128 MB	140	225	68	600	990	1400	1800	10,2	2,1	0,31	2,18	3,24	2,20	
23128 C	140	225	68	660	1080	1500	2000	11,8	2,1	0,27	2,50	3,72	2,50	
23128 GMEX	140	225	68	567	912,7	1100	1400	10,9	2,1	0,28	2,43	3,61	2,37	
23128 MB	140	225	69	600	990	1400	1800	10,5	2,1	0,31	2,18	3,24	2,20	
23328 CA	140	300	118	1350	1780	1100	1500	41,7	4,0	0,40	1,69	2,51	1,65	
23328 MA C4 F80	140	300	118	1200	1680	1000	1400	35,9	4,0	0,43	1,90	2,90	1,80	
24128 CA	140	225	85	634	1100	920	1200	13,1	2,1	0,35	1,94	2,88	1,89	
24128 CA	140	225	85	638	1150	850	1100	13,5	2,1	0,37	1,80	2,70	1,80	
24128 MB	140	225	85	740	1280	850	1100	13,2	2,1	0,38	1,78	2,64	1,80	
24128 GMEX	140	225	85	673,2	1169,1	1200	1600	13,5	2,1	0,35	1,95	2,90	1,91	
22228 CA	140	250	68	656	920	1600	2200	14,3	3,0	0,27	2,49	3,71	2,43	
22228 CA	140	250	68	616	930	1700	2200	16,2	3,0	0,26	2,60	3,90	2,50	
22228 GMEX	140	250	68	681,3	966,4	1900	2200	14,2	3,0	0,27	2,49	3,71	2,43	
22228 MB	140	250	68	670	990	1300	1700	14,0	3,0	0,30	2,25	3,35	2,30	
22228 C	140	250	68	730	1080	1400	1900	14,4	3,0	0,27	2,50	3,72	2,50	
22228 GMEX	140	250	68	681,3	966,4	1900	2200	14,2	3,0	0,27	2,49	3,71	2,43	
23228 MB	140	250	68	880	1380	1000	1300	18,5	3,0	0,38	1,78	2,64	1,80	
23228 CA	140	250	88	818	1230	1000	1400	18,9	3,0	0,35	1,92	2,85	1,87	
23228 CA	140	250	88	1000	1365	1200	1600	19,7	3,0	0,33	2,00	3,00	2,00	
23228 GMEX	140	250	88	846,5	1324,5	1100	1500	19,7	3,0	0,34	2,00	2,97	1,95	
22328 CA	140	300	102	1140	1550	1200	1600	35,9	4,0	0,35	1,91	2,85	1,87	
22328 CA	140	300	102	1330	1950	1100	1500	36,2	4,0	0,35	1,90	2,90	1,80	
22328 VS C4 F80	140	300	102	1240	1720	1400	1500	35,9	4,0	0,35	2,00	2,90	1,90	
22328 MA C4 F80	140	300	102	1240	1720	1000	1300	34,1	4,0	0,41	1,65	2,45	1,70	
22328 MB	140	300	102	1240	1720	1000	1300	34,5	4,0	0,41	1,65	2,45	1,70	
22328 C	140	300	102	1360	1870	1100	1400	45,7	4,0	0,38	1,78	2,64	1,80	
22328 GMEX	140	300	102	1190	1667,5	1200	1600	36,2	4,0	0,35	1,95	2,90	1,91	
22328 C 2RS	140	300	102	1130	1600	1400	1700	35,1	4,0	0,35	2,00	2,90	1,90	

[Index other bore sizes](#)

**BEARING STEEL 100Cr6**

- 25-55
- 60-75
- 80-90
- 95-105
- 110
- 120
- 130
- 140
- 150-260
- 280-1800



Deep Groove Ball Bearing	Self-Aligning Ball Bearing	Angular Contact Ball Bearing	
Cylindrical Roller Bearing	Tapered Roller Bearing	<b>Spherical Roller Bearing</b>	
Thrust Ball Bearing	Spherical Roller Thrust Bearing	Accessories Adapter & Withdrawal Sleeve	Technical & Related Information



# 4 5 1 0 0 n

## Spherical Roller Bearing



Click here for Technical & Related Information

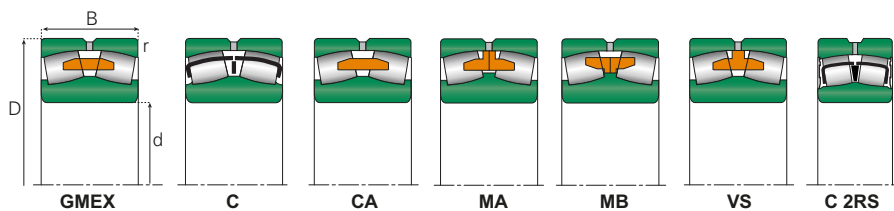

Part number	Principal dimensions			Basic load ratings		Speed limits		Weight	Radius	Calculation factors			
	Bore	Outer	Width	Dynamic	Static	Grease	Oil			rs min	e	Y1	Y2
	d	D	B	C	Co	rpm		Kg	mm				
mm			kN		1 min <sup>-1</sup>								
23030 CA	150	225	56	467	789	1400	1900	7,81	2,1	0,24	2,84	4,23	2,78
23030 CA	150	225	56	440	795	1700	2200	8,01	2,1	0,22	3,00	4,60	2,80
23030 MB	150	225	56	480	830	1400	1800	7,80	2,1	0,24	2,81	4,19	2,80
23030 C	150	225	56	520	900	1500	2000	8,57	2,1	0,24	2,81	4,19	2,80
23030 GMEX	150	225	56	481,1	819,7	1400	1800	8,01	2,1	0,24	2,84	4,23	2,78
24030 CA	150	225	75	564	1010	990	1300	10,5	2,1	0,32	2,12	3,15	2,07
24030 CA	150	225	75	550	1050	1300	1700	9,39	2,1	0,31	2,20	3,30	2,20
24030 MB	150	225	75	620	1140	1100	1400	10,5	2,1	0,33	2,05	3,05	2,10
24030 GMEX	150	225	75	596,4	1095,4	1200	1500	9,39	2,1	0,30	2,25	3,34	2,20
23130 CA	150	250	80	716	1150	1100	1500	16,2	2,1	0,31	2,16	3,22	2,12
23130 CA	150	250	80	820	1300	1400	1800	16,5	2,1	0,30	2,30	3,40	2,20
23130 MB	150	250	80	800	1320	1300	1700	16,3	2,1	0,33	2,05	3,05	2,10
23130 GMEX	150	250	80	768,9	1279,6	1050	1300	16,5	2,1	0,30	2,28	3,39	2,23
24130 CA	150	250	100	891	1520	840	1100	19,5	2,1	0,39	1,74	2,59	1,70
24130 CA	150	250	100	864	1400	800	1000	19,2	2,1	0,37	1,80	2,70	1,80
24130 C	150	250	100	1080	1840	850	1100	19,4	2,1	0,38	1,78	2,64	1,80
24130 CA	150	250	100	1080	1840	850	1100	19,5	2,1	0,43	1,57	2,34	1,60
24130 GMEX	150	250	100	897	1559,2	1100	1400	19,5	2,1	0,37	1,82	2,71	1,78
22230 CA	150	270	73	750	1060	1500	2000	18,1	3,0	0,27	2,49	3,71	2,43
22230 CA	150	270	73	693	1050	1600	2000	18,7	3,0	0,26	2,60	3,90	2,50
22230 MB	150	270	73	810	1190	1200	1600	18,0	3,0	0,30	2,25	3,35	2,30
22230 C	150	270	73	880	1300	1400	1800	18,8	3,0	0,27	2,50	3,72	2,50
22230 GMEX	150	270	73	835,1	1189,9	1800	2000	18,7	3,0	0,27	2,51	3,73	2,45
23230 CA	150	270	96	925	1450	980	1300	24,3	3,0	0,36	1,87	2,79	1,83
23230 CA	150	270	96	1050	1550	1100	1500	26,6	3,0	0,35	1,90	2,90	1,80
23230 MB	150	270	96	1030	1610	1000	1300	24,5	3,0	0,41	1,65	2,45	1,70
23230 GMEX	150	270	96	1036	1586,1	1000	1400	26,6	3,0	0,35	1,95	2,90	1,91
22330 CA	150	320	108	1270	1750	1100	1500	43,7	4,0	0,35	1,92	2,86	1,88
22330 CA	150	320	108	1230	1810	1000	1400	41,5	4,0	0,36	1,87	2,79	1,83
22330 VS C4 F80	150	320	108	1400	1940	1000	1300	44,3	4,0	0,38	2,00	2,90	1,90
22330 MA C4 F80	150	320	108	1400	1940	1000	1300	43,1	4,0	0,41	1,65	2,45	1,70
22330 MB	150	320	108	1400	1940	1000	1300	43,5	4,0	0,41	1,65	2,45	1,70
22330 C	150	320	108	1520	2110	1100	1400	44,6	4,0	0,38	1,78	2,64	1,80
22330 GMEX	150	320	108	1279	1796,2	1100	1500	41,5	4,0	0,34	1,97	2,94	1,93
22330 C 2RS	150	320	108	1270	1740	1200	1500	42,8	4,0	0,37	2,00	3,00	1,90

[Index other bore sizes](#)

**BEARING STEEL 100Cr6**

- 25-140
- 150
- 160
- 170
- 180
- 190
- 200
- 220
- 240-260
- 280-1800





Deep Groove Ball Bearing	Self-Aligning Ball Bearing	Angular Contact Ball Bearing	
Cylindrical Roller Bearing	Tapered Roller Bearing	<b>Spherical Roller Bearing</b>	
Thrust Ball Bearing	Spherical Roller Thrust Bearing	Accessories Adapter & Withdrawal Sleeve	Technical & Related Information



# 4 5 1 0 0 r

## Spherical Roller Bearing



Click here for  
Technical & Related  
Information

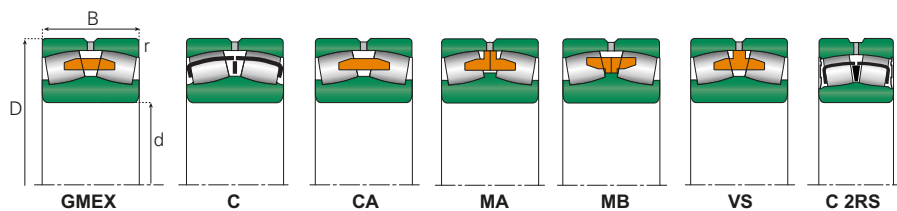

Part number	Principal dimensions			Basic load ratings		Speed limits		Weight	Radius	Calculation factors			
	Bore	Outer	Width	Dynamic	Static	Grease	Oil			rs min	e	Y1	Y2
	d	D	B	C	Co	rpm		Kg	mm				
mm			kN		1 min <sup>-1</sup>								
23032 CA	160	240	60	538	917	1300	1700	9,56	2,1	0,24	2,84	4,23	2,78
23032 CA	160	240	60	490	875	1700	2200	10,0	2,1	0,22	3,00	4,60	2,80
23032 MB	160	240	60	560	970	1300	1700	9,50	2,1	0,24	2,81	4,19	2,80
23032 MB	160	240	60	560	970	1300	1700	9,70	2,1	0,24	2,81	4,19	2,80
23032 C	160	240	60	610	1060	1400	1900	10,4	2,1	0,24	2,81	4,19	2,80
23032 GMEX	160	240	60	551,1	946,9	1300	1700	10,0	2,1	0,22	3,01	4,48	2,94
24032 CA	160	240	80	655	1180	930	1200	13,0	2,1	0,32	2,12	3,15	2,07
24032 CA	160	240	80	627	1210	1100	1500	13,2	2,1	0,30	2,30	3,40	2,20
24032 MB	160	240	80	720	1320	1000	1300	13,0	2,1	0,34	1,99	2,96	2,00
24032 MB	160	240	80	720	1320	1000	1300	13,3	2,1	0,34	1,99	2,96	2,00
24032 GMEX	160	240	80	699,4	1303	1100	1400	13,2	2,1	0,31	2,21	3,29	2,16
23132 CA	160	270	86	841	1370	1000	1400	20,8	2,1	0,31	2,16	3,22	2,12
23132 CA	160	270	86	842	1430	1300	1700	21,9	2,1	0,30	2,30	3,40	2,20
23132 MB	160	270	86	930	1510	1200	1600	20,5	2,1	0,33	2,05	3,05	2,10
23132 C	160	270	86	1010	1640	1400	1800	22,9	2,1	0,31	2,18	3,24	2,20
23132 GMEX	160	270	86	871,9	1428,7	1000	1250	21,9	2,1	0,30	2,27	3,38	2,22
23332 VS C4 F80	160	340	136	1480	2170	1100	1300	52,8	4,0	0,43	1,59	2,36	1,55
23332 MA C4 F80	160	340	136	1480	2170	1000	1300	63,5	4,0	0,40	1,59	2,37	1,60
24132 CA	160	270	109	1050	1810	780	1000	26,1	2,1	0,39	1,71	2,54	1,67
24132 CA	160	270	109	1120	1690	700	900	23,4	2,1	0,40	1,69	2,51	1,65
24132 C	160	270	109	1350	2110	850	1100	25,5	2,1	0,43	1,57	2,34	1,60
24132 GMEX	160	270	109	1093	1912,1	1000	1300	23,4	2,1	0,38	1,80	2,68	1,76
22232 CA	160	290	80	879	1220	1400	1900	22,8	3,0	0,28	2,43	3,61	2,37
22232 CA	160	290	80	825	1300	1500	1900	24,6	3,0	0,27	2,50	3,70	2,50
22232 GMEX	160	290	80	915,7	1289,3	1700	1800	22,8	3,0	0,28	2,43	3,61	2,37
22233 CA	160	290	80	825	1300	1500	1900	24,1	3,0	0,27	2,50	3,70	2,50
22232 MB	160	290	80	950	1420	1100	1500	23,3	3,0	0,30	2,25	3,35	2,30
22232 C	160	290	80	1040	1550	1300	1700	24,9	3,0	0,27	2,50	3,72	2,50
22232 GMEX	160	290	80	915,7	1289,3	1700	1800	24,1	3,0	0,28	2,43	3,61	2,37
23232 CA	160	290	104	1050	1670	910	1200	31,7	3,0	0,36	1,87	2,79	1,83
23232 CA	160	290	104	1050	1770	1000	1400	30,2	3,0	0,35	1,90	2,90	1,80
23232 MB	160	290	104	1180	1830	900	1200	31,7	3,0	0,41	1,65	2,45	1,70
23232 GMEX	160	290	104	1142	1801,9	950	1300	30,2	3,0	0,34	1,96	2,93	1,92
22332 CA	160	340	114	1350	1860	1000	1400	51,9	4,0	0,35	1,91	2,85	1,87
22332 CA	160	340	114	1400	2050	950	1300	52,8	4,0	0,35	1,90	2,90	1,80
22332 VS C4 F80	160	340	114	1520	1810	1100	1300	50,7	4,0	0,37	1,80	2,70	1,80
22332 MA C4 F80	160	340	114	1520	2160	900	1200	50,5	4,0	0,38	1,78	2,64	1,80
22332 MA C4 F80	160	340	114	1520	2160	900	1240	50,8	4,0	0,24	2,81	4,19	2,80
22332 MB	160	340	114	1520	2160	900	1200	50,8	4,0	0,38	1,78	2,64	1,80
22332 C	160	340	114	1660	2350	1000	1300	52,6	4,0	0,38	1,78	2,64	1,80
22332 GMEX	160	340	114	1460	2063,2	1050	1400	52,8	4,0	0,34	1,97	2,94	1,93

Index other bore sizes  
BEARING STEEL 100Cr6

- 25-140
- 150
- 160
- 170
- 180
- 190
- 200
- 220
- 240-260
- 280-1800



Deep Groove Ball Bearing	Self-Aligning Ball Bearing	Angular Contact Ball Bearing	
Cylindrical Roller Bearing	Tapered Roller Bearing	<b>Spherical Roller Bearing</b>	
Thrust Ball Bearing	Spherical Roller Thrust Bearing	Accessories Adapter & Withdrawal Sleeve	Technical & Related Information



# 45100s

## Spherical Roller Bearing



Click here for  
Technical & Related  
Information

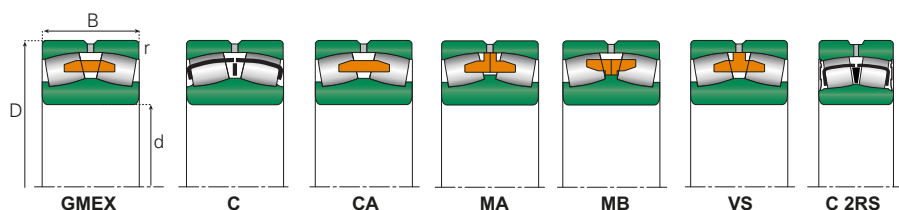

Part number	Principal dimensions			Basic load ratings		Speed limits		Weight	Radius	Calculation factors			
	Bore	Outer	Width	Dynamic	Static	Grease	Oil			rs min	e	Y1	Y2
	d	D	B	C	Co	rpm		Kg	mm				
mm			kN		1 min <sup>-1</sup>								
23034 CA	170	260	67	652	1110	1200	1600	13,0	2,1	0,25	2,74	4,08	2,68
23034 CA	170	260	67	611	1090	1600	2000	14,1	2,1	0,23	2,90	4,40	2,80
23034 MB	170	260	67	680	1170	1200	1600	13,4	2,1	0,24	2,81	4,19	2,80
23034 C	170	260	67	750	1270	1400	1800	14,2	2,1	0,24	2,81	4,19	2,80
23034 GMEX	170	260	67	660,3	1150,7	1200	1600	14,1	2,1	0,23	2,91	4,34	2,85
24034 CA	170	260	90	800	1470	860	1200	17,6	2,1	0,33	2,07	3,09	2,03
24034 CA	170	260	90	776	1500	1000	1400	17,8	2,1	0,33	2,00	3,00	2,00
24034 MB	170	260	90	880	1610	1000	1300	17,7	2,1	0,34	1,99	2,96	2,00
24034 GMEX	170	260	90	826,3	1516,9	1000	1300	17,8	2,1	0,31	2,15	3,21	2,11
23134 CA	170	280	88	887	1490	990	1300	22,2	2,1	0,31	2,21	3,29	2,16
23134 CA	170	280	88	852	1390	1200	1600	26,1	2,1	0,30	2,30	3,40	2,20
23134 MB	170	280	88	990	1650	1100	1500	22,3	2,1	0,33	2,05	3,05	2,10
23134 C	170	280	88	1080	1800	1300	1070	27,3	2,1	0,31	2,18	3,24	2,20
23134 GMEX	170	280	88	977,3	1617,9	950	1200	26,1	2,1	0,30	2,26	3,37	2,21
24134 CA	170	280	109	1080	1870	740	990	26,4	2,1	0,37	1,83	2,72	1,79
24134 CA	170	280	109	1010	1830	670	850	24,7	2,1	0,37	1,80	2,70	1,80
24134 CA	170	280	109	1280	2230	750	1000	26,4	2,1	0,41	1,65	2,45	1,70
24134 C	170	280	109	1280	2230	750	1000	27,3	2,1	0,38	1,78	2,64	1,80
24134 GMEX	170	280	109	1125	1969,8	1000	1300	26,4	2,1	0,36	1,88	2,80	1,84
22234 CA	170	310	86	983	1380	1300	1800	29,2	4,0	0,28	2,41	3,59	2,35
22234 CA	170	310	86	930	1450	1300	1700	26,8	4,0	0,27	2,50	3,70	2,50
22234 MB	170	310	86	1080	1610	1100	1400	28,9	4,0	0,31	2,18	3,24	2,20
22234 C	170	310	86	1170	1750	1200	1600	31,7	4,0	0,27	2,50	3,72	2,50
22234 GMEX	170	310	86	1023	1495,4	1300	1600	26,8	4,0	0,27	2,54	3,78	2,48
23234 CA	170	310	110	1230	1970	840	1100	35,8	4,0	0,34	1,99	2,96	1,94
23234 CA	170	310	110	1180	1930	950	1300	38,0	4,0	0,34	1,99	2,96	1,94
23234 C	170	310	110	1460	2320	900	1200	35,7	4,0	0,38	1,78	2,64	1,80
23234 CA	170	310	110	1460	2320	900	1200	37,2	4,0	0,38	1,78	2,64	1,80
23234 MB	170	310	110	1340	2120	850	1100	37,8	4,0	0,38	1,78	2,64	1,80
23234 GMEX	170	310	110	1258	1996,6	900	1200	37,2	4,0	0,34	1,98	2,95	1,94
22334 CA	170	360	120	1500	2090	980	1300	61,1	4,0	0,35	1,91	2,85	1,87
22334 CA	170	360	120	1450	2120	950	1300	62,6	4,0	0,34	1,99	2,96	1,94
22334 VS C4 F80	170	360	120	1690	1960	1100	1200	60,2	4,0	0,37	1,80	2,70	1,80
22334 MA C4 F80	170	360	120	1690	2380	850	1100	60,2	4,0	0,38	1,78	2,64	1,80
22334 MB	170	360	120	1690	2380	850	1100	62,2	4,0	0,38	1,78	2,64	1,80
22334 C	170	360	120	1850	2590	900	1200	65,3	4,0	0,34	1,99	2,96	2,00
22334 GMEX	170	360	120	1541	2187,7	980	1300	62,6	4,0	0,34	1,99	2,97	1,95
22324 C 2RS	170	260	86	848	1129	1700	2000	22,5	3,0	0,34	2,00	3,00	2,00

Index other bore sizes

BEARING STEEL 100Cr6

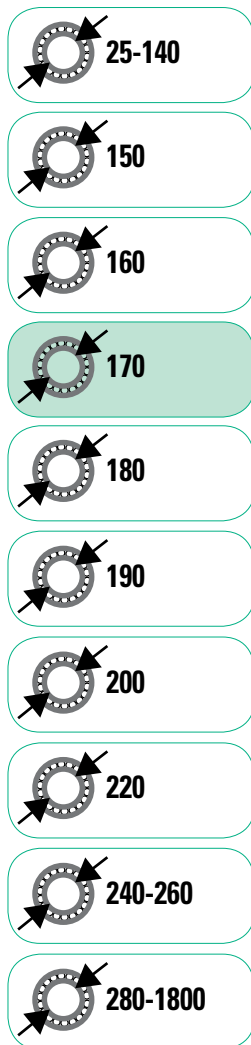



Deep Groove Ball Bearing	Self-Aligning Ball Bearing	Angular Contact Ball Bearing	
Cylindrical Roller Bearing	Tapered Roller Bearing	<b>Spherical Roller Bearing</b>	
Thrust Ball Bearing	Spherical Roller Thrust Bearing	Accessories Adapter & Withdrawal Sleeve	Technical & Related Information



# 45100t

## Spherical Roller Bearing



Click here for  
Technical & Related  
Information

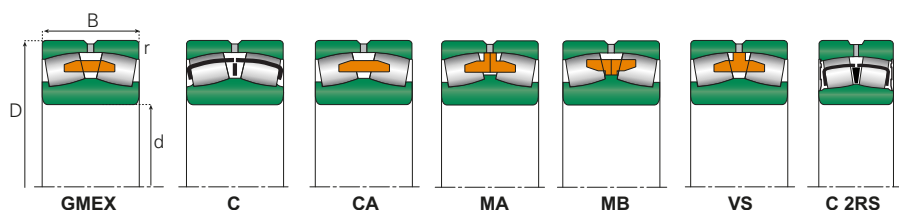

Part number	Principal dimensions			Basic load ratings		Speed limits		Weight	Radius	Calculation factors			
	Bore	Outer	Width	Dynamic	Static	Grease	Oil			rs min	e	Y1	Y2
	d	D	B	C	Co	rpm		Kg	mm				
mm			kN		1 min <sup>-1</sup>								
23936 CA	180	250	52	473	830	1700	2200	7,34	2,0	0,18	3,80	5,60	3,60
23036 CA	180	280	74	702	1170	1100	1500	17,3	2,1	0,24	2,76	4,11	2,70
23036 CA	180	280	74	693	1280	1400	1800	17,7	2,1	0,25	2,70	4,00	2,60
23036 MB	180	280	74	800	1380	1100	1500	17,6	2,1	0,24	2,81	4,19	2,80
23036 C	180	280	74	870	1500	1300	1700	19,8	2,1	0,24	2,81	4,19	2,80
23036 GMEX	180	280	74	750,6	1325,2	1100	1500	17,7	2,1	0,24	2,84	4,23	2,78
23036 MB	180	280	100	1030	1900	900	1200	23,0	2,1	0,36	1,88	2,79	1,90
24036 CA	180	280	100	936	1710	810	1100	23,5	2,1	0,34	1,99	2,96	1,94
24036 CA	180	280	100	919	1750	950	1300	26,6	2,1	0,33	2,00	3,00	2,00
24036 MB	180	260	100	1030	1900	900	1200	23,2	2,1	0,36	1,88	2,79	1,90
24036 GMEX	180	280	100	990,9	1865,7	1100	1300	26,6	2,1	0,32	2,09	3,11	2,04
23136 CA	180	300	96	999	1650	930	1200	28,0	3,0	0,32	2,13	3,17	2,08
23136 CA	180	300	96	990	1720	1100	1500	27,1	3,0	0,30	2,30	3,40	2,20
23136 MB	180	300	96	1160	1940	1100	1400	28,4	3,0	0,33	2,05	3,05	2,10
23136 C	180	300	96	1260	2110	1200	1600	30,6	3,0	0,31	2,18	3,24	2,20
23136 GMEX	180	300	96	1166	1927	880	1100	27,1	3,0	0,30	2,25	3,35	2,20
24136 CA	180	300	118	1240	2180	700	930	32,6	3,0	0,38	1,77	2,64	1,73
24136 CA	180	300	118	1120	2030	630	800	33,0	3,0	0,37	1,80	2,70	1,80
24136 C	180	300	118	1460	2590	700	950	33,7	3,0	0,43	1,57	2,34	1,60
24136 GMEX	180	300	118	1297	2293	900	1200	33,0	3,0	0,37	1,85	2,75	1,81
22236 CA	180	320	86	1040	1490	1300	1700	30,0	4,0	0,27	2,51	3,74	2,45
22236 CA	180	320	86	985	1550	1300	1700	29,4	4,0	0,26	2,60	3,90	2,50
22236 GMEX	180	320	86	1061	1591	1300	1500	58,8	4,0	0,26	2,64	3,93	2,58
22236 MB	180	320	86	1110	1720	1100	1400	30,4	4,0	0,30	2,25	3,35	2,30
22236 C	180	320	86	1210	1870	1100	1500	33,1	4,0	0,27	2,50	3,72	2,50
22236 GMEX	180	320	86	1061	1590,9	1300	1500	58,8	4,0	0,26	2,64	3,93	2,58
23236 CA	180	320	112	1270	2050	820	1100	39,5	4,0	0,35	1,94	2,88	1,89
23236 CA	180	320	112	1280	2130	900	1200	38,7	4,0	0,35	1,90	2,90	1,80
23236 MB	180	320	112	1420	2330	750	1000	40,8	4,0	0,38	1,78	2,64	1,80
23236 GMEX	180	320	112	1326	2116	850	1100	38,7	4,0	0,34	2,01	3,00	1,97
22336 CA	180	380	126	1640	2290	930	1200	71,4	4,0	0,35	1,92	2,86	1,88
22336 CA	180	380	126	1620	2400	900	1200	72,2	4,0	0,34	1,99	2,96	1,94
22336 VS C4 F80	180	380	126	1900	2170	1000	1100	69,3	4,0	0,36	1,90	2,80	1,80
22336 MB	180	380	126	1900	2700	850	1100	68,2	4,0	0,38	1,78	2,64	1,80
22336 MA C4 F80	180	380	126	1900	2700	850	1100	68,2	4,0	0,38	1,78	2,64	1,80
22336 GMEX	180	380	126	1828	2601,5	930	1200	72,2	4,0	0,34	2,00	2,97	1,95

Index other bore sizes

BEARING STEEL 100Cr6

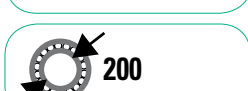



Deep Groove Ball Bearing	Self-Aligning Ball Bearing	Angular Contact Ball Bearing	
Cylindrical Roller Bearing	Tapered Roller Bearing	<b>Spherical Roller Bearing</b>	
Thrust Ball Bearing	Spherical Roller Thrust Bearing	Accessories Adapter & Withdrawal Sleeve	Technical & Related Information



# 4 5 1 0 0 u

## Spherical Roller Bearing

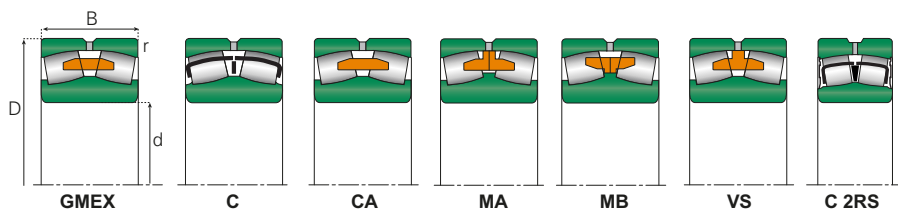

Click here for Technical & Related Information

Part number	Principal dimensions			Basic load ratings		Speed limits		Weight	Radius	Calculation factors			
	Bore	Outer	Width	Dynamic	Static	Grease	Oil			rs min	e	Y1	Y2
	d	D	B	C	Co	rpm		Kg	mm				
<b>23938 CA</b>	190	260	52	440	855	1600	2000	8,29	2,0	0,18	3,80	5,60	3,60
<b>23038 CA</b>	190	290	75	781	1360	1100	1400	18,2	2,1	0,24	2,76	4,11	2,70
<b>23038 CA</b>	190	290	75	770	1450	1300	1700	17,3	2,1	0,23	2,90	4,40	2,80
<b>23038 MB</b>	190	290	75	830	1470	1100	1400	18,6	2,1	0,26	2,60	3,87	2,60
<b>23038 C</b>	190	290	75	900	1610	1200	1600	19,8	2,1	0,16	4,22	6,28	4,40
<b>23038 GMEX</b>	190	290	75	784,3	1379,9	1050	1400	17,3	2,1	0,24	2,84	4,23	2,78
<b>24038 CA</b>	190	290	100	931	1800	780	1000	23,8	2,1	0,33	2,07	3,09	2,03
<b>24038 CA</b>	190	290	100	941	1840	950	1300	22,9	2,1	0,31	2,20	3,30	2,20
<b>24038 MB</b>	190	290	100	1080	1980	850	1100	24,3	2,1	0,34	1,99	2,96	2,00
<b>24038 GMEX</b>	190	290	100	1025	1944,7	900	1200	22,9	2,1	0,31	2,16	3,22	2,12
<b>23138 CA</b>	190	320	104	1170	1960	870	1200	34,9	3,0	0,32	2,12	3,15	2,07
<b>23138 CA</b>	190	320	104	1140	1840	1000	1400	34,3	3,0	0,31	2,20	3,30	2,20
<b>23138 C</b>	190	320	104	1320	2290	1100	1400	35,0	3,0	0,34	1,99	2,96	2,00
<b>23138 MB</b>	190	320	104	1320	2290	1100	1400	35,6	3,0	0,34	1,99	2,96	2,00
<b>23138 GMEX</b>	190	320	104	1235	2078,9	800	1000	34,3	3,0	0,31	2,21	3,29	2,16
<b>24138 CA</b>	190	320	128	1330	2340	650	870	41,5	3,0	0,37	1,82	2,71	1,78
<b>24138 CA</b>	190	320	128	1320	2400	600	750	41,9	3,0	0,40	1,69	2,51	1,65
<b>24138 CA</b>	190	320	128	1680	3000	670	900	41,6	3,0	0,43	1,57	2,34	1,60
<b>24138 MB</b>	190	320	128	1540	2750	600	800	41,8	3,0	0,43	1,57	2,34	1,60
<b>24138 GMEX</b>	190	320	128	1491	2654,7	850	1100	41,6	3,0	0,37	1,82	2,70	1,78
<b>22238 CA</b>	190	340	92	1150	1700	1200	1600	37,3	4,0	0,27	2,49	3,71	2,43
<b>22238 CA</b>	190	340	92	1050	1620	1200	1600	37,4	4,0	0,26	2,60	3,90	2,50
<b>22238 MB</b>	190	340	92	1220	1870	1000	1300	37,7	4,0	0,30	2,25	3,35	2,30
<b>22238 GMEX</b>	190	340	92	1213	1825,7	1200	1500	37,4	4,0	0,26	2,62	3,90	2,56
<b>23238 C</b>	190	340	92	1330	2640	1100	1400	40,0	4,0	0,27	2,50	3,72	2,50
<b>23238 CA</b>	190	340	120	1420	2340	760	1000	48,0	4,0	0,33	2,03	3,03	1,99
<b>23238 CA</b>	190	340	120	1420	2400	850	1100	44,8	4,0	0,35	1,90	2,90	1,80
<b>23238 MB</b>	190	340	120	1610	2640	750	1000	48,9	4,0	0,38	1,78	2,64	1,80
<b>23238 C</b>	190	340	120	1750	2880	850	1100	52,4	4,0	0,38	1,78	2,64	1,80
<b>23238 GMEX</b>	190	340	120	1539	2517,8	780	1050	44,8	4,0	0,34	1,99	2,96	1,94
<b>22338 CA</b>	190	400	132	1810	2540	880	1200	82,7	5,0	0,35	1,94	2,88	1,89
<b>22338 CA</b>	190	400	132	1800	2630	850	1100	82,2	5,0	0,34	1,99	2,96	1,94
<b>22338 MB</b>	190	400	132	2060	2920	750	1000	84,8	5,0	0,38	1,78	2,64	1,80
<b>22338 MA C4 F80</b>	190	400	132	1610	2640	750	1000	48,8	4,0	0,36	1,90	2,80	1,80
<b>22338 GMEX</b>	190	400	132	1964	2814,1	880	1100	82,2	5,0	0,35	1,95	2,90	1,91

[Index other bore sizes](#)

**BEARING STEEL 100Cr6**

- 25-140
- 150
- 160
- 170
- 180
- 190
- 200
- 220
- 240-260
- 280-1800



Deep Groove Ball Bearing	Self-Aligning Ball Bearing	Angular Contact Ball Bearing	
Cylindrical Roller Bearing	Tapered Roller Bearing	<b>Spherical Roller Bearing</b>	
Thrust Ball Bearing	Spherical Roller Thrust Bearing	Accessories Adapter & Withdrawal Sleeve	Technical & Related Information



# 4 5 1 0 0 v

## Spherical Roller Bearing

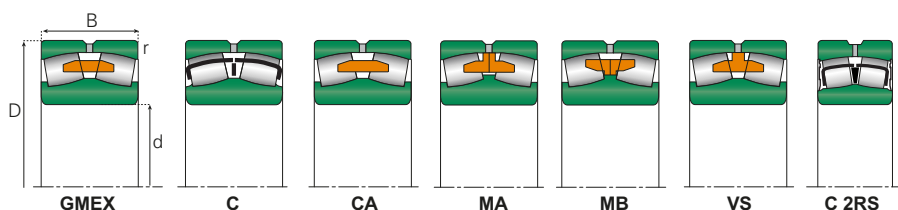

Click here for Technical & Related Information

Part number	Principal dimensions			Basic load ratings		Speed limits		Weight	Radius	Calculation factors			
	Bore	Outer	Width	Dynamic	Static	Grease	Oil			rs min	e	Y1	Y2
	d	D	B	C	Co	rpm		Kg	mm				
mm			kN		1 min <sup>-1</sup>								
23940 CA	200	280	60	545	1150	1600	2000	12,1	2,1	0,19	3,61	5,38	3,53
23940 MB	200	280	60	525	1020	1100	1400	11,5	2,1	0,21	3,21	4,79	3,30
23040 CA	200	310	82	867	1470	1000	1400	23,3	2,1	0,24	2,76	4,11	2,70
23040 CA	200	310	82	847	1560	1200	1600	22,6	2,1	0,25	2,70	4,00	2,60
23040 CA	200	310	82	880	1560	1100	1500	23,5	2,1	0,24	2,81	4,19	2,80
23040 GMEX	200	310	82	947,7	1706,6	1000	1300	23,5	2,1	0,24	2,83	4,22	2,77
24040 CA	200	310	109	1170	2170	730	970	31,4	2,1	0,33	2,03	3,02	1,98
24040 CA	200	310	109	1080	2130	900	1200	31,3	2,1	0,33	2,00	3,00	2,00
24040 CA	200	310	109	1140	2060	850	1100	30,5	2,1	0,34	1,99	2,96	2,00
24040 GMEX	200	310	109	1132	2164,5	850	1100	30,5	2,1	0,32	2,12	3,15	2,07
23140 CA	200	340	112	1370	2310	830	1100	43,1	3,0	0,32	2,09	3,11	2,04
23140 CA	200	340	112	1300	2240	950	1300	43,8	3,0	0,31	2,20	3,30	2,20
23140 CA	200	340	112	1370	2460	1100	1400	43,5	3,0	0,36	1,88	2,79	1,90
23140 GMEX	200	340	112	1432	2502,2	750	950	43,5	3,0	0,31	2,19	3,26	2,14
23340 CA	200	420	165	2220	3500	750	950	122	5,0	0,40	1,68	2,50	1,64
24140 CA	200	340	140	1590	2790	620	830	53,3	3,0	0,40	1,68	2,50	1,64
24140 CA	200	340	140	1520	2800	5601	700	52,1	3,0	0,40	1,70	2,50	1,60
24140 MB	200	340	140	1400	2385	560	750	51,5	3,0	0,43	1,57	2,34	1,60
24140 GMEX	200	340	140	1704	3082	800	1000	52,1	3,0	0,39	1,75	2,61	1,71
22240 CA	200	360	98	1290	1910	1100	1500	43,2	4,0	0,27	2,47	3,67	2,41
22240 CA	200	360	98	1210	1950	1100	1500	44,7	4,0	0,26	2,60	3,90	2,50
22240 CA	200	360	98	1250	2020	1100	1400	45,0	4,0	0,30	2,25	3,35	2,30
22240 GMEX	200	360	98	1333	2052,3	1100	1400	45,0	4,0	0,26	2,59	3,86	2,53
23240 CA	200	360	128	1580	2620	730	970	57,8	4,0	0,36	1,90	2,83	1,86
23240 CA	200	360	128	1530	2530	850	1100	53,4	4,0	0,35	1,90	2,90	1,80
23240 MB	200	360	128	1620	2590	750	1000	58,5	4,0	0,38	1,78	2,64	1,80
23240 GMEX	200	360	128	1733	2883,2	700	1000	53,4	4,0	0,34	2,00	2,98	1,96
22340 CA	200	420	138	1990	2800	840	1100	95,2	5,0	0,35	1,95	2,90	1,91
22340 CA	200	420	138	1910	2860	850	1100	97,0	5,0	0,34	1,99	2,96	1,94
22340 MA C4 F80	200	420	138	1910	2750	670	900	97,3	5,0	0,36	1,80	2,80	1,80
22340 MB	200	420	138	1910	2750	670	900	95,0	5,0	0,38	1,78	2,64	1,80
22340 GMEX	200	420	138	2147	3089,1	800	1000	97,0	5,0	0,35	1,95	2,90	1,91

[Index other bore sizes](#)

**BEARING STEEL 100Cr6**

- 25-140
- 150
- 160
- 170
- 180
- 190
- 200
- 220
- 240-260
- 280-1800



Deep Groove Ball Bearing	Self-Aligning Ball Bearing	Angular Contact Ball Bearing	
Cylindrical Roller Bearing	Tapered Roller Bearing	<b>Spherical Roller Bearing</b>	
Thrust Ball Bearing	Spherical Roller Thrust Bearing	Accessories Adapter & Withdrawal Sleeve	Technical & Related Information

# 4 5 1 0 0 w

## Spherical Roller Bearing



Click here for  
Technical & Related  
Information

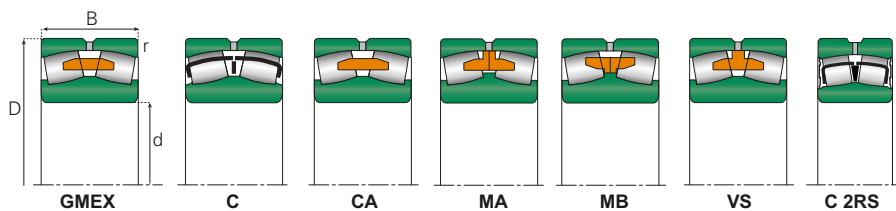

Part number	Principal dimensions			Basic load ratings		Speed limits		Weight	Radius	Calculation factors			
	Bore	Outer	Width	Dynamic	Static	Grease	Oil			rs min	e	Y1	Y2
	d	D	B	C	Co	rpm		Kg	mm				
mm			kN		1 min <sup>-1</sup>								
23944 CA	220	300	60	550	1190	1500	1900	12,9	2,1	0,18	3,80	5,60	3,60
23944 C	220	300	60	625	1344	1100	1500	13,0	2,1	0,18	3,75	5,58	3,70
23944 MB	220	300	60	555	1036	1100	1400	13,5	2,1	0,18	3,75	5,58	3,70
23044 CA	220	340	90	1030	1790	930	1200	31,0	3,0	0,24	2,79	4,15	2,73
23044 CA	220	340	90	1030	1900	1100	1500	32,0	3,0	0,24	2,80	4,20	2,80
23044 C	220	340	90	1155	2053	1100	1400	30,5	3,0	0,24	2,81	4,19	2,80
23044 CA	220	340	90	1090	1890	1100	1400	31,0	3,0	0,24	2,81	4,19	2,80
23044 MB	220	340	90	1025	1730	1000	1300	31,5	3,0	0,24	2,81	4,19	2,80
23044 GMEX	220	340	90	1119	2046,8	950	1200	31,0	3,0	0,24	2,84	4,23	2,78
24044 CA	220	340	118	1370	2550	660	880	40,5	3,0	0,33	2,07	3,09	2,03
24044 CA	220	340	118	1270	2500	850	1100	39,1	3,0	0,33	2,00	3,00	2,00
24044 MB	220	340	118	1190	2098	750	1000	39,5	3,0	0,36	1,88	2,79	1,90
24044 GMEX	220	340	118	1346	2565	750	1000	39,1	3,0	0,32	2,12	3,15	2,07
23144 CA	220	370	120	1500	2570	760	1000	54,1	4,0	0,31	2,21	3,29	2,16
23144 CA	220	370	120	1510	2710	900	1200	54,7	4,0	0,30	2,30	3,40	2,20
23144 CA	220	370	120	1515	2509	1000	1300	52,0	4,0	0,31	2,18	3,24	2,20
23144 MB	220	370	120	1455	2380	900	1200	54,5	4,0	0,31	2,18	3,24	2,20
23144 GMEX	220	370	120	1665	2943,6	700	900	52,0	4,0	0,30	2,24	3,34	2,19
24144 CA	220	370	150	1870	3390	570	750	67,5	4,0	0,39	1,71	2,54	1,67
24144 CA	220	370	150	1800	3410	500	630	66,4	4,0	0,40	1,70	2,50	1,60
24144 MB	220	370	150	1780	3109	530	700	65,0	4,0	0,43	1,57	2,34	1,60
22244 CA	220	400	108	1560	2260	1000	1400	59,5	4,0	0,26	2,55	3,80	2,50
22244 CA	220	400	108	1490	2400	950	1300	63,5	4,0	0,27	2,50	3,70	2,50
22244 GMEX	220	400	108	1603	2510	1000	1300	58,8	4,0	0,26	2,61	3,88	2,55
22244 CA	220	400	108	1575	2355	900	1200	62,0	4,0	0,30	2,25	3,35	2,30
22244 MB	220	400	108	1485	2483	850	1100	63,0	4,0	0,30	2,25	3,35	2,30
22244 GMEX	220	400	108	1603	2509,8	1000	1300	62,0	4,0	0,26	2,61	3,88	2,55
23244 CA	220	400	144	1960	3270	660	880	81,5	4,0	0,36	1,87	2,79	1,83
23244 CA	220	400	144	1950	3200	750	950	77,3	4,0	0,36	1,89	2,81	1,85
23244 C	220	400	144	2065	3380	670	900	79,5	4,0	0,38	1,78	2,64	1,80
23244 CA	220	400	144	1990	3220	670	900	81,5	4,0	0,38	1,78	2,64	1,80
23244 MB	220	400	144	1850	2899	600	800	82,5	4,0	0,38	1,78	2,64	1,80
23244 GMEX	220	400	144	2087	3513,9	670	900	81,5	4,0	0,35	1,95	2,90	1,91
22344 CA	220	460	145	2370	3450	980	1360	119	5,0	0,32	2,09	3,11	2,04
22344 C	220	460	145	2450	3614	700	950	120	5,0	0,38	1,78	2,64	1,80
22344 GMEX	220	460	145	2414	3533,4	730	900	119	5,0	0,33	2,06	3,07	2,02

[Index other bore sizes](#)  
**BEARING STEEL 100Cr6**

- 25-140
- 150
- 160
- 170
- 180
- 190
- 200
- 220
- 240-260
- 280-1800



Deep Groove Ball Bearing	Self-Aligning Ball Bearing	Angular Contact Ball Bearing	<b>Spherical Roller Bearing</b>
Cylindrical Roller Bearing	Tapered Roller Bearing	Accessories Adapter & Withdrawal Sleeve	
Thrust Ball Bearing	Spherical Roller Thrust Bearing	Technical & Related Information	



**4 5 1 0 0 x**

## Spherical Roller Bearing



Click here for Technical & Related Information

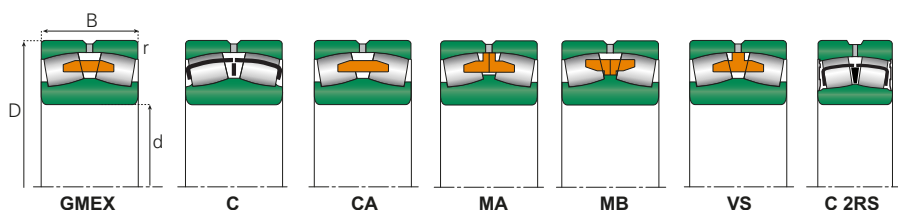

Part number	Principal dimensions			Basic load ratings		Speed limits		Weight	Radius	Calculation factors				
	Bores	Outer	Width	Dynamic	Static	Grease	Oil			e	Y1	Y2	Yo	
	d	D	B	C	Co	rpm		rs min	mm					
	mm			kN		1 min <sup>-1</sup>		Kg	mm	mm				
23948 CA	240	320	60	530	1310	1300	1700	15,0	2,1	0,15	4,50	6,70	4,50	
23948 MB	240	320	60	600	1170	1000	1300	14,0	2,1	0,18	3,75	5,58	3,90	
23048 CA	240	360	92	1130	2080	870	1200	34,3	3,0	0,24	2,81	4,19	2,75	
23048 CA	240	360	92	1080	2080	1000	1400	34,2	3,0	0,24	2,80	4,20	2,80	
23048 CA	240	360	92	1145	2048	1000	1300	34,0	3,0	0,24	2,81	4,19	2,80	
23048 MB	240	360	92	1105	1969	900	1200	34,5	3,0	0,24	2,81	4,19	2,80	
23048 GMEX	240	360	92	1166	2154,2	870	1150	34,0	3,0	0,23	2,94	4,38	2,88	
24048 CA	240	360	118	1400	2680	620	830	43,6	3,0	0,31	2,21	3,29	2,16	
24048 CA	240	360	118	1360	2800	800	1000	46,5	3,0	0,30	2,30	3,40	2,20	
24048 CA	240	360	118	1460	2841	750	1000	42,5	3,0	0,33	2,05	3,05	2,10	
24048 GMEX	240	360	118	1388	2690,2	700	900	42,5	3,0	0,32	2,12	3,15	2,07	
23148 CA	240	400	128	1680	3060	700	930	66,3	4,0	0,32	2,13	3,17	2,08	
23148 CA	240	400	128	1650	3000	850	1100	68,2	4,0	0,31	2,21	3,29	2,16	
23148 CA	240	400	128	1705	2863	900	1200	66,0	4,0	0,31	2,18	3,24	2,20	
23148 MB	240	400	128	1640	2720	850	1100	67,5	4,0	0,31	2,18	3,24	2,20	
23148 GMEX	240	400	128	1914	3416,5	670	800	66,0	4,0	0,30	2,27	3,38	2,22	
24148 CA	240	400	160	2110	3880	520	700	83,8	4,0	0,39	1,74	2,59	1,70	
24148 CA	240	400	160	2010	3400	480	600	79,0	4,0	0,40	1,70	2,50	1,60	
24148 MB	240	400	160	1970	3477	480	630	80,5	4,0	0,43	1,57	2,34	1,60	
24148 GMEX	240	400	160	2155	3981,3	700	800	79,0	4,0	0,39	1,74	2,59	1,70	
22248 CA	240	440	120	1970	2870	1000	1400	80,7	4,0	0,28	2,45	3,64	2,39	
22248 CA	240	440	120	2000	2850	900	1200	85,3	4,0	0,27	2,50	3,70	2,50	
22248 CA	240	440	120	1845	2763	850	1100	83,0	4,0	0,30	2,25	3,35	2,30	
22248 MB	240	440	120	1815	2701	750	1000	85,5	4,0	0,30	2,25	3,35	2,30	
22248 GMEX	240	440	120	1927	3076,9	900	1100	83,0	4,0	0,26	2,55	3,80	2,50	
23248 CA	240	440	160	2520	3950	670	850	102	4,0	0,35	1,90	2,90	1,80	
23248 CA	240	440	160	2530	4600	630	850	109	4,0	0,38	1,78	2,64	1,80	
23248 MB	240	440	160	2370	3837	560	750	110	4,0	0,38	1,78	2,64	1,80	
23248 GMEX	240	440	160	2559	4351	630	800	109	4,0	0,35	1,95	2,90	1,91	
22348 CA	240	500	155	2740	3990	650	800	149	5,0	0,32	2,09	3,11	2,04	
22348 MB	240	500	155	2650	4000	560	750	151	5,0	0,31	2,18	3,24	2,20	
2650C CA	250	410	128	1860	3350	1000	1400	59,4	4,0	0,29	2,30	3,50	2,40	
23952 CA	260	360	75	902	1750	1100	1500	21,6	2,1	0,18	3,80	5,60	3,60	
23952 MB	260	360	75	845	1604	850	1100	24,0	2,1	0,20	3,38	5,03	3,50	
23052 CA	260	400	104	1420	2520	870	1200	47,8	4,0	0,25	2,69	4,00	2,63	
23052 CA	260	400	104	1350	2550	900	1200	49,8	4,0	0,23	2,90	4,40	2,80	
23052 C	260	400	104	1540	2796	900	1200	48,5	4,0	0,24	2,81	4,19	2,80	
23052 CA	260	400	104	1430	2533	900	1200	49,5	4,0	0,24	2,81	4,19	2,80	
23052 MB	260	400	104	1380	2417	850	1100	50,5	4,0	0,24	2,81	4,19	2,80	
23052 GMEX	260	400	104	1464	2624,6	850	1100	49,5	4,0	0,25	2,69	4,00	2,63	
24052 CA	260	400	140	1650	3340	560	750	66,0	4,0	0,33	2,07	3,09	2,03	
24052 CA	260	400	140	1710	3500	700	900	66,7	4,0	0,33	2,00	3,00	2,00	
24052 MB	260	400	140	1775	3494	600	800	66,0	4,0	0,34	1,99	2,96	2,00	
24052 GMEX	260	400	140	1716	3410,8	630	850	66,7	4,0	0,32	2,13	3,17	2,08	
23152 CA	260	440	144	2140	3660	1100	1500	88,7	4	0,32	2,12	3,15	2,07	
23152 CA	260	440	144	2250	3900	800	1000	87,5	4,0	0,31	2,20	3,30	2,20	
23152 CA	260	440	144	2155	3673	850	1100	92,5	4,0	0,31	2,18	3,24	2,20	
23152 MB	260	440	144	2025	3391	750	1000	93,5	4,0	0,31	2,18	3,24	2,20	
24152 CA	260	440	180	2650	4940	480	640	115	4,0	0,40	1,70	2,53	1,66	
24152 CA	260	440	180	2100	4350	430	530	115	4,0	0,39	1,73	2,58	1,69	
22252 CA	260	480	130	2230	3350	1000	1400	113	5,0	0,27	2,47	3,67	2,41	
22252 CA	260	480	130	2280	3600	850	1100	106	5,0	0,27	2,51	3,74	2,45	
22252 CA	260	480	130	2190	3300	750	1000	107	5,0	0,30	2,25	3,35	2,30	
22252 MB	260	480	130	2150	3232	670	900	111	5,0	0,30	2,25	3,35	2,30	
23252 CA	260	480	174	2800	4750	630	800	141	5,0	0,35	1,90	2,90	1,80	
23252 MB	260	480	174	2700	4350	500	670	142	5,0	0,38	1,78	2,64	1,80	
22352 CA	260	540	165	3080	4750	630	800	186	6,0	0,31	2,20	3,30	2,20	
22352 C	260	540	165	3215	4836	600	800	187	6,0	0,38	1,78	2,64	1,80	
22352 C	260	540	165	3215	4836	600	800	187	6,0	0,38	1,78	2,64	1,80	

Index other bore sizes

BEARING STEEL 100Cr6





Deep Groove Ball Bearing	Self-Aligning Ball Bearing	Angular Contact Ball Bearing	
Cylindrical Roller Bearing	Tapered Roller Bearing	<b>Spherical Roller Bearing</b>	
Thrust Ball Bearing	Spherical Roller Thrust Bearing	Accessories Adapter & Withdrawal Sleeve	Technical & Related Information



# 4 5 1 0 0 z

## Spherical Roller Bearing



Click here for Technical & Related Information

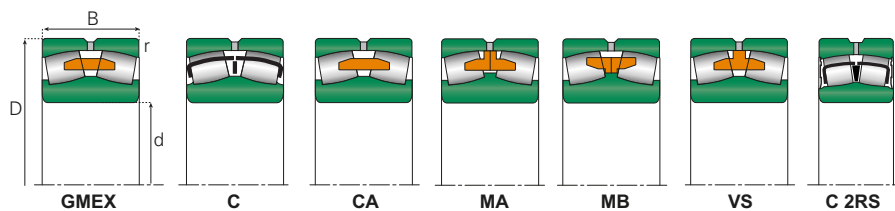

Part number	Principal dimensions			Basic load ratings		Speed limits		Weight	Radius	Calculation factors			
	Bore	Outer	Width	Dynamic	Static	Grease	Oil			rs min	e	Y1	Y2
	d	D	B	C	Co	rpm		mm	mm				
	mm			kN		1 min <sup>-1</sup>		Kg					
23856 CA	280	350	52	435	1230	800	1000	11,4	2,0	0,13	5,36	7,98	5,24
23956 CA	280	380	75	803	1850	1000	1400	25,7	2,1	0,18	3,80	5,66	3,72
23956 C	280	380	75	845	1767	900	1200	26,0	2,1	0,18	3,75	5,58	3,70
23956 C	280	380	75	845	1767	900	1200	26,0	2,1	0,18	3,75	5,58	3,70
23056 CA	280	420	106	1480	2710	870	1200	53,8	4,0	0,24	2,79	4,15	2,73
23056 CA	280	420	106	1450	2850	850	1100	56,8	4,0	0,23	2,91	4,40	2,84
23056 C	280	420	106	1530	2830	850	1100	50,5	4,0	0,24	2,81	4,19	2,80
23056 CA	280	420	106	1500	2731	850	1100	52,0	4,0	0,24	2,81	4,19	2,80
23056 MB	280	420	106	1430	2571	750	1000	53,0	4,0	0,24	2,81	4,19	2,80
23056 MB	280	420	106	1430	2571	750	1000	53,0	2,8	0,24	2,81	4,19	2,80
23056 GMEX	280	420	106	1570	2980,2	800	1000	52,0	4,0	0,23	2,92	4,35	2,86
24056 CA	280	420	140	1940	3940	560	750	69,2	4,0	0,31	2,16	3,22	2,12
24056 CA	280	420	140	1780	3700	670	850	69,2	4,0	0,31	2,20	3,30	2,20
24056 MB	280	420	140	1795	2471	607	50	68,5	4,0	0,27	2,50	3,72	2,50
23156 CA	280	460	146	2270	4020	700	930	14,0	5,0	0,31	2,18	3,24	2,13
23156 CA	280	460	146	2190	4150	750	950	104	5,0	0,30	2,30	3,40	2,20
23156 CA	280	460	146	2295	4050	750	1000	98,5	5,0	0,31	2,18	3,24	2,20
23156 MB	280	460	146	2295	4050	670	900	100	5,0	0,31	2,18	3,24	2,20
24156 CA	280	460	180	2530	4750	400	500	119	5,0	0,40	1,70	2,50	1,60
24156 MB	280	460	180	2635	4848	400	530	118	5,0	0,41	1,65	2,45	1,70
22256 CA	280	500	130	2320	3590	810	1100	117	5,0	0,26	2,60	3,87	2,54
22256 CA	280	500	130	2190	3600	800	1000	118	5,0	0,26	2,60	3,90	2,50
22256 C	280	500	130	2330	4074	700	950	113	5,0	0,30	2,25	3,35	2,30
22256 C	280	500	130	2330	4074	700	950	113	5,0	0,30	2,25	3,35	2,30
22256 CA	280	500	130	2280	3546	700	950	115	5,0	0,30	2,25	3,35	2,30
22256 MB	280	500	130	2260	3502	630	850	116	5,0	0,30	2,25	3,35	2,30
23256 MB	280	500	130	2806	4645	480	630	153	5,0	0,38	1,78	2,64	1,80
23256 CA	280	500	176	2840	5100	600	750	147	5,0	0,35	1,90	2,90	1,80
22356 CA	280	580	175	3520	5700	600	750	221	6,0	0,30	2,30	3,40	2,20
23860 CA	300	380	60	640	1650	950	1400	18,2	3,0	0,13	5,20	7,70	5,00
23960 CA	300	420	90	1160	2500	950	1300	40,1	3,0	0,19	3,60	5,30	3,60
23960 MB	300	420	90	1175	2261	750	1000	40,0	3,0	0,21	3,21	4,79	3,30
23060 CA	300	460	118	1810	3280	870	1200	73,4	4,0	0,25	2,74	4,08	2,68
23060 CA	300	460	118	1770	3450	800	1000	75,8	4,0	0,23	2,90	4,40	2,80
23060 CA	300	460	118	1815	3268	750	1000	71,0	4,0	0,24	2,81	4,19	2,80
23060 MB	300	460	118	1720	3052	670	900	73,5	4,0	0,24	2,81	4,19	2,80
24060 CA	300	460	160	2220	2700	600	750	99,0	4,0	0,32	2,09	3,11	2,04
24060 CA	300	460	160	2385	4702	560	750	97,0	4,0	0,36	1,88	2,79	1,90
23160 CA	300	500	160	2640	4730	700	930	99,0	5,0	0,31	2,16	3,22	2,12
23160 CA	300	500	160	2800	5100	670	850	126	5,0	0,30	2,30	3,40	2,20
23160 CA	300	500	160	2635	4485	700	950	129	5,0	0,31	2,18	3,24	2,20
23160 MB	300	500	160	2508	4318	630	850	130	5,0	0,31	2,18	3,24	2,20
24160 CA	300	500	200	3100	6000	600	750	161	5,0	0,39	1,75	2,61	1,71
24160 CA	300	500	200	3213	6011	430	560	159	5,0	0,43	1,57	2,34	1,60
22260 CA	300	540	140	2620	4300	750	950	138	5,0	0,26	2,60	3,90	2,50
22260 CA	300	540	140	2670	4176	670	900	142	5,0	0,30	2,25	3,35	2,30
22260 MB	300	540	140	2615	4072	600	800	145	5,0	0,30	2,25	3,35	2,30
23260 CA	300	540	192	3300	5600	530	670	192	5,0	0,35	1,90	2,90	1,80
23260 CA	300	540	192	3418	5778	500	670	192	5,0	0,38	1,78	2,64	1,80
23260 MB	300	540	192	3305	5528	450	600	195	5,0	0,38	1,78	2,64	1,80

Index other bore sizes

BEARING STEEL 100Cr6

- 25-140
- 150-260
- 280-300
- 320-360
- 380-420
- 440-500
- 530-670
- 710-950
- 1000-1800





Deep Groove Ball Bearing	Self-Aligning Ball Bearing	Angular Contact Ball Bearing	
Cylindrical Roller Bearing	Tapered Roller Bearing	<b>Spherical Roller Bearing</b>	
Thrust Ball Bearing	Spherical Roller Thrust Bearing	Accessories Adapter & Withdrawal Sleeve	Technical & Related Information

# 4 5 1 0 1 a

## Spherical Roller Bearing



Click here for Technical & Related Information

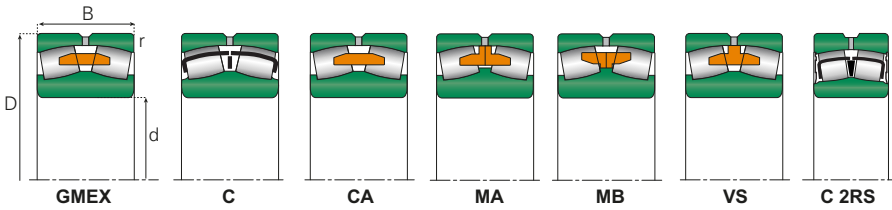

Part number	Principal dimensions			Basic load ratings		Speed limits		Weight	Radius	Calculation factors			
	Bore	Outer	Width	Dynamic	Static	Grease	Oil			rs min	e	Y1	Y2
	d	D	B	C	Co	rpm		mm	mm				
23864 CA	320	400	60	670	1620	920	1280	20,3	2,1	0,12	5,60	8,40	5,60
23964 CA	320	440	90	1200	2650	900	1200	42,7	3,0	0,18	3,80	5,60	3,60
23964 MB	320	440	90	1215	2409	670	900	42,0	3,0	0,20	3,38	5,03	3,50
23964 CA	320	480	121	1895	3511	700	950	79,0	4,0	0,24	2,81	4,19	2,80
23064 CA	320	480	121	1930	3900	800	1000	84,8	4,0	0,23	2,90	4,40	2,80
23064 MB	320	480	121	1810	3313	630	850	79,5	4,0	0,24	2,81	4,19	2,80
24064 CA	320	480	160	2480	5100	560	700	105	4,0	0,32	2,09	3,11	2,04
24064 CA	320	480	160	2500	5240	530	700	106	4,0	0,34	1,99	2,96	2,00
23164 CA	320	540	176	3150	3200	630	800	200	5,0	0,31	2,20	3,30	2,20
23164 CA	320	540	176	3115	5477	670	900	165	5,0	0,36	1,88	2,79	1,90
23164 MB	320	540	176	2855	4892	600	800	171	5,0	0,36	1,88	2,79	1,90
24164 CA	320	540	218	3560	6500	340	430	206	5,0	0,40	1,70	2,50	1,60
24164 CA	320	540	218	3750	7300	400	530	215	5,0	0,43	1,57	2,34	1,60
22264 CA	320	580	150	3000	4550	670	850	175	5,0	0,26	2,60	3,90	2,50
22264 CA	320	580	150	3150	5100	630	850	180	5,0	0,27	2,50	3,72	2,50
22264 MB	320	580	150	3095	4892	560	750	181	5,0	0,27	2,50	3,72	2,50
23264 CA	320	580	208	3900	6800	500	630	253	5,0	0,35	1,90	2,90	1,80
23264 CA	320	580	208	4130	7060	480	630	241	5,0	0,38	1,78	2,64	1,80
23264 MB	320	580	208	4130	7060	430	560	247	5,0	0,38	1,78	2,64	1,80
22364 CA	320	670	200	4650	6990	480	630	339	7,5	0,31	2,18	3,24	2,20
23968 CA	340	460	90	1200	2700	900	1200	46,0	3,0	0,17	4,00	5,90	4,00
23968 MB	340	460	90	1306	2691	630	850	45,0	3,0	0,18	3,75	5,58	3,70
23068 CA	340	520	133	1980	4400	700	900	115	5,0	0,24	2,84	4,23	2,78
23068 CA	340	520	133	2272	4184	670	900	106	5,0	0,24	2,81	4,19	2,80
23068 MB	340	520	133	2203	4020	600	800	108	5,0	0,24	2,81	4,19	2,80
24068 CA	340	520	180	3000	6100	530	670	137	5,0	0,32	2,12	3,15	2,07
24068 CA	340	520	180	3000	6350	500	670	143	5,0	0,36	1,88	2,79	1,90
23168 CA	340	580	190	3650	6700	600	750	182	5,0	0,31	2,20	3,30	2,20
23168 CA	340	580	190	3605	6409	630	850	212	5,0	0,31	2,18	3,24	2,20
23168 MB	340	580	190	3270	5520	560	750	216	5,0	0,31	2,18	3,24	2,20
23168 MB	340	580	190	3270	5520	560	750	216	2,2	0,31	2,18	3,24	2,20
24168 CA	340	580	243	4400	7950	320	400	256	5,0	0,40	1,70	2,50	1,60
24166 CA	340	580	243	4575	8710	380	500	282	5,0	0,46	1,47	2,18	1,50
24168 CA	340	580	243	4575	8710	380	500	282	5,0	0,46	1,47	2,18	1,50
24168 MB	340	580	243	4290	8005	340	450	283	5,0	0,46	1,47	2,18	1,50
23268 CA	340	620	224	4400	7700	430	530	297	6,0	0,35	1,90	2,90	1,80
23268 CA	340	620	224	4577	7918	450	600	305	6,0	0,38	1,78	2,64	1,80
23772 MB	360	600	192	3443	6031	530	700	228	5,0	0,31	2,18	3,24	2,20
24712 CA	360	600	243	4510	8525	360	480	279	5,0	0,43	1,57	2,34	1,70
23972 CA	360	480	90	1290	2820	850	1100	46,6	3,0	0,16	4,20	6,30	4,00
23972 MB	360	480	90	1230	2527	600	800	46,0	3,0	0,18	3,75	5,58	3,90
23072 CA	360	540	134	2280	4800	670	850	126	5,0	0,23	2,90	4,40	2,80
23072 CA	360	540	134	2367	4481	630	850	110	5,0	0,24	2,81	4,19	2,80
23072 MB	360	540	134	2255	4214	560	750	111	5,0	0,24	2,81	4,19	2,80
24072 CA	360	540	180	2820	6100	600	750	150	5,0	0,31	2,20	3,30	2,20
24072 CA	360	540	180	3150	6530	480	630	145	5,0	0,34	1,99	2,96	2,00
23172 CA	360	600	192	3750	7000	560	700	255	5,0	0,30	2,30	3,40	2,20
23172 CA	360	600	192	3740	7010	600	800	220	5,0	0,31	2,18	3,24	2,20
24172 CA	360	600	243	5600	8400	300	380	270	5,0	0,37	1,80	2,70	1,80
22272 CA	360	650	170	3630	6200	380	480	253	6,0	0,26	2,60	3,87	2,54
22272 CA	360	650	170	3955	6435	360	750	255	6,0	0,27	2,50	3,72	2,50
23272 CA	360	650	232	4650	8300	400	500	335	6,0	0,35	1,90	2,90	1,80
22372 CA	360	750	224	4900	8600	400	500	460	7,5	0,31	2,21	3,29	2,16

Index other bore sizes  
BEARING STEEL 100Cr6

- 25-140
- 150-260
- 280-300
- 320-360
- 380-420
- 440-500
- 530-670
- 710-950
- 1000-1800



Deep Groove Ball Bearing	Self-Aligning Ball Bearing	Angular Contact Ball Bearing	
Cylindrical Roller Bearing	Tapered Roller Bearing	<b>Spherical Roller Bearing</b>	
Thrust Ball Bearing	Spherical Roller Thrust Bearing	Accessories Adapter & Withdrawal Sleeve	Technical & Related Information

# 4 5 1 0 1 b

## Spherical Roller Bearing



Click here for  
Technical & Related  
Information

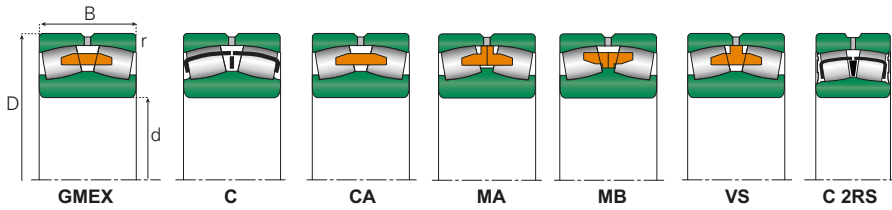

Part number	Principal dimensions			Basic load ratings		Speed limits		Weight	Radius	Calculation factors			
	Bore	Outer	Width	Dynamic	Static	Grease	Oil			rs min	e	Y1	Y2
	d	D	B	C	Co	rpm		Kg	mm	mm			
23976 CA	380	520	106	1730	3800	800	1000	69,5	4,0	0,17	4,00	5,90	4,00
23976 CA	380	520	106	1785	3750	630	850	70,0	4,0	0,20	3,38	5,03	3,50
23076 CA	380	560	135	2480	5000	630	800	130	5,0	0,22	3,00	4,60	2,80
23076 CA	380	560	135	2500	488	600	800	115	5,0	0,24	2,81	4,19	2,80
23076 MB	380	560	135	2225	4195	530	700	117	5,0	0,24	2,81	4,19	2,80
24076 CA	380	560	180	3150	6900	480	600	150	5,0	0,30	2,30	3,40	2,20
24076 CA	380	560	180	3150	6710	450	600	152	5,0	0,33	2,05	3,05	2,10
23176 CA	380	620	194	3900	7380	1100	1500	250	5,0	0,30	2,23	3,32	2,18
23176 CA	380	620	194	3740	7350	400	500	250	5,0	0,30	2,30	3,40	2,20
23176 CA	380	620	194	3740	7540	560	750	240	5,0	0,31	2,18	3,24	2,20
23176 MB	380	620	194	3535	6350	500	670	242	5,0	0,31	2,18	3,24	2,20
24176 CA	380	620	243	4400	9200	300	380	296	5,0	0,30	2,30	3,40	2,20
24176 CA	380	620	243	4500	9565	340	450	300	5,0	0,41	1,65	2,45	1,70
23276 CA	380	680	240	4800	9200	380	480	386	6,0	0,35	1,90	2,90	1,80
23276 CA	380	680	240	5050	9660	400	530	375	6,0	0,38	1,78	2,64	1,80
23276 MB	380	680	240	4880	8440	360	480	390	6,0	0,38	1,78	2,64	1,80
23980 CA	400	540	106	1750	3950	750	950	72,4	4,0	0,17	4,00	5,90	4,00
23980 CA	400	540	106	1850	3990	600	800	72,0	4,0	0,18	3,75	5,58	3,70
23080 CA	400	590	142	2650	5600	630	800	133	5,0	0,21	3,14	4,68	3,07
23080 CA	400	600	148	2855	5465	560	750	150	5,0	0,24	2,81	4,19	2,80
23080 MB	400	600	148	2645	4970	500	570	152	5,0	0,24	2,81	4,19	2,80
24080 CA	400	600	200	3600	7800	450	560	202	5,0	0,30	2,30	3,40	2,20
24080 CA	400	600	200	3610	7545	430	560	205	5,0	0,34	1,99	2,96	2,00
23180 CA	400	650	200	4240	8070	1100	1500	275	6,0	0,30	2,26	3,37	2,21
23180 CA	400	650	200	4100	7650	380	480	275	6,0	0,28	2,40	3,60	2,50
23180 CA	400	650	200	4100	7730	530	700	265	6,0	0,27	2,50	3,72	2,50
23180 MB	400	650	200	3920	7164	480	630	270	6,0	0,27	2,50	3,72	2,50
24180 CA	400	650	250	4800	9600	320	400	326	6,0	0,36	1,87	2,79	1,83
24180 CA	400	650	250	5230	10500	320	430	340	6,0	0,41	1,65	2,45	1,70
23280 CA	400	720	256	6150	11300	340	430	350	6,0	0,35	1,90	2,90	1,80
22380 CA	400	820	243	5400	9600	340	430	623	7,5	0,31	2,21	3,29	2,16
22380 CA	400	820	243	6960	11031	400	530	645	7,5	0,31	2,18	3,24	2,20
22380 MB	400	820	243	6570	10233	360	480	648	7,5	0,31	2,18	3,24	2,20
23884 CA	420	520	75	950,0	2630	750	950		2,1	0,12	5,60	8,40	5,60
23984 CA	420	560	106	1530	4050	700	900	72,4	4,0	0,16	4,20	6,30	4,00
23984 CA	420	560	106	1960	4130	600	800	75,0	4,0	0,18	3,75	5,58	3,70
23084 MB	420	560	106	1960	4130	600	670	75,0	4,0	0,18	3,75	5,58	3,70
23084 CA	420	620	150	2970	6400	450	560	150	5,0	0,22	3,00	4,60	2,80
23084 CA	420	620	150	3050	6055	560	750	155	5,0	0,25	2,70	4,02	2,70
23084 MB	420	620	150	2825	5480	500	670	160	5,0	0,25	2,70	4,02	2,70
24084 CA	420	620	200	3690	8450	380	480	202	5,0	0,30	2,30	3,40	2,20
24084 CA	420	620	200	3753	7910	430	560	210	5,0	0,33	2,05	3,05	2,10
23184 CA	420	700	224	4680	9200	360	450	353	6,0	0,30	2,30	3,40	2,20
23184 CA	420	700	224	4600	9000	500	670	363	6,0	0,34	1,99	2,96	2,00
23184 CA	420	700	224	4600	9000	500	670	363	2,0	0,34	1,99	2,96	2,00
24184 CA	420	700	280	5750	11100	300	380	436	6,0	0,38	1,80	2,60	1,70
24184 CA	420	700	280	5770	13065	300	400	445	6,0	0,43	1,57	2,34	1,60
23284 CA	420	760	272	6170	11900	320	400	550	7,5	0,35	1,90	2,90	1,80
23284 CA	420	760	272	6575	11717	360	480	540	7,5	0,38	1,78	2,64	1,80
23284 MB	420	760	272	6215	10720	320	430	553	7,5	0,38	1,78	2,64	1,80

Index other bore sizes  
BEARING STEEL 100Cr6

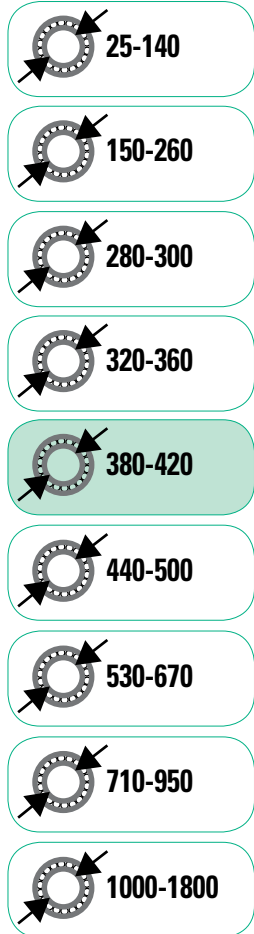



Deep Groove Ball Bearing	Self-Aligning Ball Bearing	Angular Contact Ball Bearing	
Cylindrical Roller Bearing	Tapered Roller Bearing	<b>Spherical Roller Bearing</b>	
Thrust Ball Bearing	Spherical Roller Thrust Bearing	Accessories Adapter & Withdrawal Sleeve	Technical & Related Information

# 4 5 1 0 1 c

## Spherical Roller Bearing



Click here for Technical & Related Information

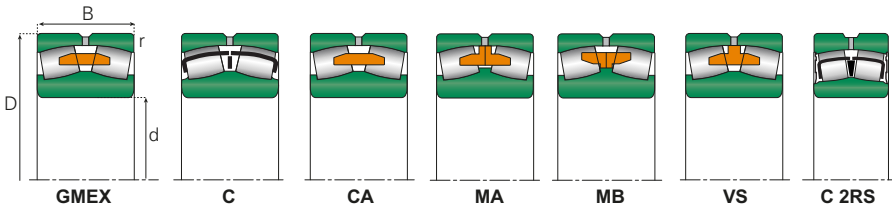

Part number	Principal dimensions			Basic load ratings		Speed limits		Weight Kg	Radius rs min mm	Calculation factors			
	Bore d	Outer D	Width B	Dynamic C	Static Co	Grease rpm	Oil rpm			e	Y1	Y2	Yo
	mm			kN		1 min <sup>-1</sup>				mm			
23988 CA	440	600	118	2030	4850	450	560	101	4,0	0,17	4,00	5,90	4,00
23988 CA	440	600	118	2100	4690	560	750	102	4,0	0,18	3,75	5,58	3,70
23088 CA	440	650	157	3150	6500	430	530	179	6,0	0,22	3,00	4,60	2,80
23088 CA	440	650	157	3345	6700	530	700	180	6,0	0,24	2,81	4,19	2,80
24088 CA	440	650	212	4150	9100	360	450	251	6,0	0,30	2,30	3,40	2,20
24088 CA	440	650	212	4100	8850	400	530	245	6,0	0,33	2,05	3,05	2,10
24088 MB	440	650	212	4100	8850	400	530	245	6,0	0,33	2,05	3,05	2,10
23188 CA	440	720	226	4950	10000	340	430	378	6,0	0,30	2,30	3,40	2,20
23188 CA	440	720	226	5250	10000	500	670	360	6,0	0,31	2,18	3,24	2,20
24188 CA	440	720	280	7300	13400	300	380	469	6,0	0,37	1,80	2,70	1,80
24188 CA	440	720	280	6000	12300	300	400	460	6,0	0,41	1,65	2,45	1,70
23288 CA	440	790	280	7600	12300	320	400	612	7,5	0,35	1,90	2,90	1,80
23288 CA	440	790	280	6700	12780	360	480	595	7,5	0,38	1,78	2,64	1,80
23289 CA	440	790	280	6700	12780	360	480	595	7,5	0,38	1,78	2,64	1,80
24892 CA	460	580	118	1730	4850	450	560	82,0	3,0	0,17	4,00	5,90	4,00
23992 CA	460	620	118	2120	5000	430	530	105	4,0	0,16	4,20	6,30	4,00
23992 CA	460	620	118	2305	5036	530	700	105	4,0	0,17	3,97	5,91	4,00
23092 CA	460	680	163	3280	6950	400	500	226	6,0	0,22	3,00	4,60	2,80
23092 CA	460	680	163	3300	6900	500	670	205	6,0	0,18	3,75	5,58	3,70
23092 MB	460	680	163	3200	6170	450	600	209	6,0	0,18	3,75	5,58	3,70
24092 CA	460	680	218	4200	9100	340	430	304	6,0	0,29	2,35	3,50	2,30
24092 CA	460	680	218	4370	9570	380	500	280	6,0	0,27	2,50	3,72	2,50
23192 CA	460	760	240	5500	10000	320	400	443	7,5	0,30	2,30	3,40	2,20
23192 CA	460	760	240	5760	11025	480	630	441	7,5	0,31	2,18	3,24	2,20
24192 CA	460	760	300	6890	14400	160	200	461	7,5	0,37	1,80	2,70	1,80
24192 CA	460	760	300	6720	13800	280	380	560	7,5	0,38	1,78	2,64	1,80
23292 CA	460	830	296	7350	13500	300	380	698	7,5	0,35	1,90	2,90	1,80
23292 CA	460	830	296	7560	13970	340	450	695	7,5	0,36	1,88	2,79	1,90
23896 CA	480	600	90	1420	4000	450	600	60,4	3,0	0,13	5,36	7,98	5,24
23996 CA	480	650	128	2370	5750	400	500	126	5,0	0,18	3,80	5,60	3,60
23996 MB	480	650	128	2525	5500	450	600	128	5,0	0,18	3,75	5,58	3,60
23096 CA	480	700	165	3300	6900	380	480	217	6,0	0,21	3,20	4,80	3,20
23096 CA	480	700	165	3300	6900	480	630	215	6,0	0,24	2,81	4,19	2,90
24096 CA	480	700	218	5250	10200	340	430	296	6,0	0,28	2,40	3,60	2,50
24096 CA	480	700	218	5023	11320	360	480	300	6,0	0,27	2,50	3,72	2,50
23196 CA	480	790	248	6100	12000	300	380	516	7,5	0,30	2,30	3,40	2,20
23196 CA	480	790	248	5800	11800	450	600	485	7,5	0,31	2,18	3,24	2,20
24196 CA	480	790	308	8000	14900	240	320	584	7,5	0,37	1,80	2,70	1,80
24196 CA	480	790	308	7820	16800	280	360	635	7,5	0,38	1,78	2,64	1,80
23296 CA	480	870	310	7750	15200	260	340	853	7,5	0,35	1,90	2,90	1,80
238/500 CA	500	620	90	1450	3800	420	520	66,0	3,0	0,12	5,60	8,40	5,60
239/500 CA	500	670	128	2530	6000	400	500	120	5,0	0,17	4,00	5,90	4,00
239/500 CA	500	670	128	2500	6090	480	630	130	5,0	0,17	3,97	5,91	4,00
230/500 CA	500	720	167	3470	7650	380	480	228	6,0	0,21	3,20	4,80	3,20
230/500 MB	500	720	167	3740	7815	430	560	225	6,0	0,21	3,21	4,79	3,20
240/500 CA	500	720	218	5400	10600	420	520	306	6,0	0,26	2,60	3,90	2,50
240/500 CA	500	720	218	4750	10610	360	480	295	6,0	0,27	2,50	3,72	2,50
231/500 CA	500	830	264	6100	13800	320	400	588	7,5	0,30	2,30	3,40	2,20
231/500 CA	500	830	264	5550	13200	430	560	580	7,5	0,31	2,18	3,24	2,20
241/500 CA	500	830	325	9600	16000	300	380	736	7,5	0,37	1,80	2,70	1,80
241/500 CA	500	830	325	8470	17100	450	600	745	7,5	0,38	1,78	2,64	1,80
232/500 CA	500	920	336	9460	18600	280	360	985	7,5	0,35	1,90	2,90	1,80

Index other bore sizes

BEARING STEEL 100Cr6

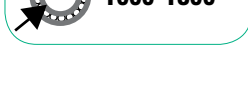
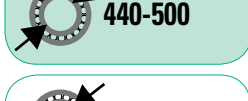



Deep Groove Ball Bearing	Self-Aligning Ball Bearing	Angular Contact Ball Bearing	
Cylindrical Roller Bearing	Tapered Roller Bearing	<b>Spherical Roller Bearing</b>	
Thrust Ball Bearing	Spherical Roller Thrust Bearing	Accessories Adapter & Withdrawal Sleeve	Technical & Related Information



# 4 5 1 0 1 d

## Spherical Roller Bearing



Click here for  
Technical & Related  
Information

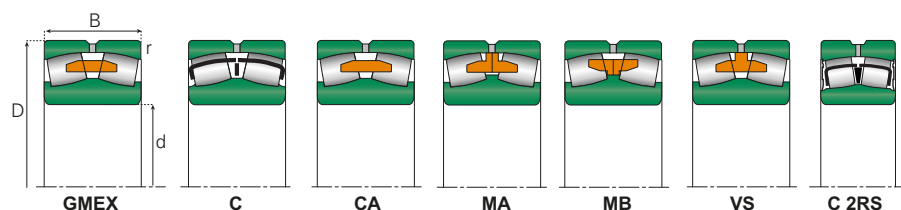

Part number	Principal dimensions			Basic load ratings		Speed limits		Weight	Radius	Calculation factors			
	Bore	Outer	Width	Dynamic	Static	Grease	Oil			rs min	e	Y1	Y2
	d	D	B	C	Co	rpm		Kg	mm				
mm			kN		1 min <sup>-1</sup>								
238/530 CA	530	650	90	1500	4200	400	500	64,2	3,0	0,12	5,60	8,40	5,60
248/530 CA	530	650	118	1820	5280	380	480	91,0	3,0	0,15	4,50	6,70	4,50
239/530 CA	530	710	136	2980	6755	450	600	150	5,0	0,17	3,97	5,91	4,00
239/530 CA	530	710	316	2900	6700	360	450	154	5,0	0,17	4,00	5,90	4,00
230/530 CA	530	780	185	4370	9650	340	430	339	6,0	0,22	3,00	4,60	2,80
230/530 CA	530	780	185	4985	10542	450	600	315	6,0	0,24	2,81	4,19	2,90
240/530 CA	530	780	250	5400	12700	280	360	416	6,0	0,29	2,30	3,50	2,40
240/530 CA	530	780	250	5640	12800	340	450	410	6,0	0,27	2,50	3,72	2,50
231/530 CA	530	870	272	8100	13200	260	340	665	7,5	0,30	2,30	3,40	2,20
231/530 CA	530	870	272	7525	15000	400	530	645	7,5	0,31	2,18	3,24	2,20
241/530 CA	530	870	335	10300	18700	190	280	846	7,5	0,37	1,80	2,80	1,80
241/530 CA	530	870	335	8630	18400	240	320	830	7,5	0,38	1,78	2,64	1,80
232/530 CA	530	980	335	10300	20300	210	290	1220	9,5	0,36	1,87	2,79	1,83
239/560 CA	560	750	140	3050	7200	340	430	177	5,0	0,16	4,20	6,30	4,00
239/560 CA	560	750	140	2980	7451	450	600	175	5,0	0,17	3,97	5,91	4,00
230/560 CA	560	820	195	4300	10500	320	410	363	6,0	0,22	3,14	4,67	3,07
230/560 CA	560	820	195	5245	11134	430	560	355	6,0	0,24	2,81	4,19	2,80
240/560 CA	560	820	258	5700	13200	220	300	471	6,0	0,28	2,40	3,60	2,50
240/560 CA	560	820	258	6200	14100	320	430	465	6,0	0,27	2,50	3,72	2,50
231/560 CA	560	750	140	2980	1500	400	530	175	5,0	0,31	2,18	3,24	2,20
231/560 CA	560	920	280	7590	15700	240	320	756	7,5	0,30	2,30	3,40	2,20
231/560 CA	560	920	280	8294	16295	380	500	740	7,5	0,31	2,18	3,24	2,20
241/560 CA	560	920	355	10000	20100	120	160	953	7,5	0,37	1,80	2,80	1,80
241/560 CA	560	920	355	9550	20600	220	300	985	7,5	0,38	1,78	2,64	1,80
232/560 CA	560	1030	365	11200	21000	190	260	1380	9,5	0,35	1,90	2,90	1,80
239/600 CA	600	800	150	3260	8400	320	400	220	5,0	0,17	4,00	5,90	4,00
239/600 CA	600	800	150	3640	8420	400	530	220	5,0	0,17	3,97	5,91	4,00
249/600 CA	600	800	200	4070	11200	320	400	287	5,0	0,22	3,00	4,60	2,80
230/600 CA	600	870	200	5170	11600	300	380	442	6,0	0,22	3,00	4,60	2,80
230/600 MB	600	870	200	5610	12020	360	480	409	6,0	0,24	2,81	4,19	2,80
240/600 CA	600	870	272	8100	16500	220	300	560	6,0	0,30	2,30	3,40	2,80
231/600 CA	600	980	300	8900	18800	180	250	894	7,5	0,29	2,30	3,50	2,40
241/600 CA	600	980	375	10000	21600	110	150	1140	7,5	0,36	1,90	2,82	1,85
241/600 CA	600	980	375	10850	22750	220	280	1200	7,5	0,38	1,78	2,64	1,80
232/600 CA	600	1090	388	12500	25000	190	260	1568	9,5	0,35	1,93	2,88	1,80
238/630 CA	630	780	112	2200	6300	300	380	124	4,0	0,12	5,60	8,40	5,60
239/630 CA	630	850	165	3550	9750	280	360	280	6,0	0,17	4,00	5,90	4,00
239/630 CA	630	850	165	1290	9910	380	500	280	6,0	0,17	3,97	5,91	4,00
230/630 CA	630	920	212	5670	12800	260	340	471	7,5	0,21	3,20	4,80	3,20
230/630 CA	630	920	212	6175	13173	380	500	485	7,5	0,21	3,21	4,79	3,20
231/630 CA	630	1030	315	10000	21000	180	250	1080	7,5	0,30	2,30	3,40	2,20
241/630 CA	630	1030	400	12500	27200	160	210	1440	7,5	0,37	1,80	2,70	1,80
238/670 CA	670	820	112	2210	6300	270	350	136	4,0	0,11	6,10	9,10	6,30
248/670 CA	670	820	150	3100	9600	270	350	178	4,0	0,16	4,20	6,30	4,00
239/670 CA	670	900	170	4400	10600	260	340	313	6,0	0,17	4,00	5,90	4,00
239/670 CA	670	900	170	4370	10300	360	480	315	6,0	0,17	3,97	5,91	4,00
230/670 CA	670	980	230	6900	15000	240	310	601	7,5	0,22	3,00	4,60	3,20
230/670 CA	670	980	230	6580	14400	340	450	600	7,5	0,21	3,21	4,79	3,20
240/670 CA	670	980	308	9500	20000	190	270	807	7,5	0,28	2,40	3,60	2,50
240/670 CA	670	980	308	8500	19500	260	340	790	7,5	0,27	2,50	3,72	2,50
231/670 CA	670	1090	336	11000	22500	175	240	1280	7,5	0,30	2,30	3,40	2,20
241/670 CA	670	1090	412	14000	31500	150	190	1560	7,5	0,36	1,87	2,79	1,83
232/670 CA	670	1220	438	15000	32000	160	210	2300	12	0,35	1,90	2,90	1,80

Index other bore sizes

BEARING STEEL 100Cr6

- 25-140
- 150-260
- 280-300
- 320-360
- 380-420
- 440-500
- 530-670
- 710-950
- 1000-1800





Deep Groove Ball Bearing	Self-Aligning Ball Bearing	Angular Contact Ball Bearing	
Cylindrical Roller Bearing	Tapered Roller Bearing	<b>Spherical Roller Bearing</b>	
Thrust Ball Bearing	Spherical Roller Thrust Bearing	Accessories Adapter & Withdrawal Sleeve	Technical & Related Information

# 4 5 1 0 1 e

## Spherical Roller Bearing



Click here for Technical & Related Information

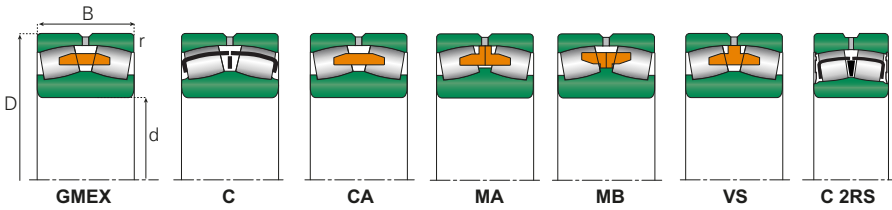

Part number	Principal dimensions			Basic load ratings		Speed limits		Weight	Radius	Calculation factors			
	Bore	Outer	Width	Dynamic	Static	Grease	Oil			rs min	e	Y1	Y2
	d	D	B	C	Co	rpm		Kg	mm				
238/710 CA	710	870	118	2680	7550	260	340	156	4,0	0,11	6,10	9,10	6,30
239/710 CA	710	950	180	5000	12000	240	310	364	6,0	0,17	4,00	5,90	4,00
239/710 CA	710	950	180	4680	12230	340	450	365	6,0	0,17	3,97	5,91	4,00
249/710 CA	710	950	243	6200	17000	200	280	500	6,0	0,22	3,00	4,60	2,80
230/710 CA	710	1030	236	6300	16200	220	300	669	7,5	0,21	3,20	4,80	3,20
230/710 CA	710	1030	236	6665	17000	320	430	670	7,5	0,21	3,21	4,79	3,20
240/710 CA	710	1030	315	9300	22500	180	250	910	7,5	0,27	2,50	3,70	2,50
240/710 CA	710	1030	315	8970	21700	240	320	895	7,5	0,27	2,50	3,72	2,50
231/710 CA	710	1150	345	12000	25800	170	220	1480	9,8	0,28	2,40	3,60	2,50
241/710 CA	710	1150	438	11900	29700	90	120	1791	9,5	0,35	1,90	2,90	1,80
232/710 CA	710	1280	450	17500	34400	160	210	2640	12	0,35	1,90	2,90	1,80
238/750 CA	750	920	128	2950	8600	240	310	188	5,0	0,11	6,10	9,10	6,30
239/750 CA	750	1000	185	5800	13500	210	290	426	6,0	0,16	4,20	6,30	4,00
239/750 CA	750	1000	185	5474	13085	320	430	420	6,0	0,17	3,97	5,91	4,00
249/750 CA	750	1000	250	7600	18200	180	250	566	6,0	0,22	3,00	4,60	2,80
230/750 CA	750	1090	250	7000	17900	200	280	789	7,5	0,21	3,20	4,80	3,20
240/750 CA	750	1090	335	10000	24800	170	220	1100	7,5	0,28	2,40	3,60	2,50
240/750 CA	750	1090	335	9960	23700	220	300	1065	7,5	0,27	2,50	3,72	2,50
231/750 CA	750	1220	365	13500	28800	160	210	1760	9,5	0,28	2,40	3,60	2,50
241/750 CA	750	1220	475	16000	37000	130	170	2195	9,5	0,35	1,90	2,90	1,80
232/750 CA	750	1360	475	16390	36000	90	120	3100	15	0,36	1,87	2,79	1,83
248/800 CA	800	980	180	4150	13000	170	220	330	5,0	0,15	4,50	6,70	4,50
239/800 CA	800	1060	195	6350	14200	190	270	480	6,0	0,16	4,20	6,30	4,00
239/800 MB	800	1060	195	6131	15016	280	360	478	6,0	0,17	3,97	5,91	4,00
249/800 CA	800	1060	258	7800	19500	175	240	648	6,0	0,21	3,20	4,80	3,20
230/800 MB	800	1150	28	9389	21295	260	340	895	7,5	0,21	3,21	4,79	3,20
230/800 CA	800	1150	258	8090	19100	170	220	894	7,5	0,20	3,40	5,00	3,20
240/800 CA	800	1150	345	10300	24600	170	220	1092	7,5	0,27	2,50	3,70	2,50
240/800 CA	800	1150	345	11305	27145	220	280	1200	7,5	0,27	2,50	3,72	2,50
231/800 CA	800	1280	375	14500	31000	150	190	1960	9,5	0,28	2,40	3,60	2,50
241/800 CA	800	1280	475	16300	37100	130	170	2350	9,5	0,35	1,90	2,90	1,80
238/850 CA	850	1030	136	3300	9800	180	250	244	5,0	0,11	6,10	9,10	6,30
239/850 CA	850	1120	200	5800	15500	180	250	570	6,0	0,16	4,20	6,30	4,00
239/850 CA	850	1120	200	6450	15880	280	380	560	6,0	0,17	3,97	5,91	4,00
249/850 CA	850	1120	272	8200	22500	170	220	750	6,0	0,22	3,00	4,60	2,80
230/850 CA	850	1220	272	8450	22500	180	240	1074	7,5	0,20	3,40	5,00	3,20
240/850 CA	850	1220	365	11400	29700	160	200	1410	7,5	0,27	2,50	3,70	2,50
240/850 CA	850	1220	365	12000	29500	220	280	1410	7,5	0,27	2,50	3,72	2,50
231/850 CA	850	1360	400	16000	34200	130	170	2260	12	0,28	2,40	3,60	2,50
241/850 CA	850	1360	500	20000	45100	105	140	2750	12	0,35	1,90	2,90	1,80
248/900 CA	900	1090	190	4890	15500	210	375	370	5,0	0,14	4,80	7,20	4,50
239/900 CA	900	1180	206	6050	16400	180	240	611	6,0	0,15	4,50	6,70	4,50
239/900 CA	900	1180	206	6930	17120	280	360	605	6,0	0,15	4,50	6,70	4,50
230/900 CA	900	1280	280	10200	23500	160	210	1220	7,5	0,20	3,40	5,00	3,20
240/900 CA	900	1280	375	13000	34200	140	190	1600	7,5	0,26	2,60	3,90	2,50
240/900 CA	900	1280	375	14400	35500	200	260	1570	7,5	0,27	2,50	3,72	2,50
241/900 CA	900	1420	515	21000	48500	95	140	3400	12	0,35	1,90	2,90	1,80
239/950 CA	950	1250	224	7350	19000	160	225	759	7,5	0,15	4,50	6,70	4,50
239/950 CAF	950	1250	224	7310	19500	260	340	755	7,5	0,15	4,50	6,70	4,50
249/950 CA	950	1250	300	9300	25500	135	180	1030	7,5	0,21	3,20	4,80	3,20
230/950 CA	950	1360	300	11000	26800	150	210	1440	7,5	0,20	3,40	5,00	3,20
240/950 CA	950	1360	412	15000	38500	125	160	2100	7,5	0,27	2,50	3,70	2,50
240/950 CAF	950	1360	412	15210	39375	180	240	1990	7,5	0,27	2,50	3,72	2,50
241/950 CA	950	1500	545	24000	54500	90	125	3600	7,5	0,35	1,90	2,90	1,80

Index other bore sizes

BEARING STEEL 100Cr6

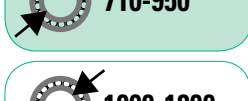



Deep Groove Ball Bearing	Self-Aligning Ball Bearing	Angular Contact Ball Bearing	
Cylindrical Roller Bearing	Tapered Roller Bearing	<b>Spherical Roller Bearing</b>	
Thrust Ball Bearing	Spherical Roller Thrust Bearing	Accessories Adapter & Withdrawal Sleeve	Technical & Related Information



# 4 5 1 0 1 f

## Spherical Roller Bearing



Click here for  
Technical & Related  
Information

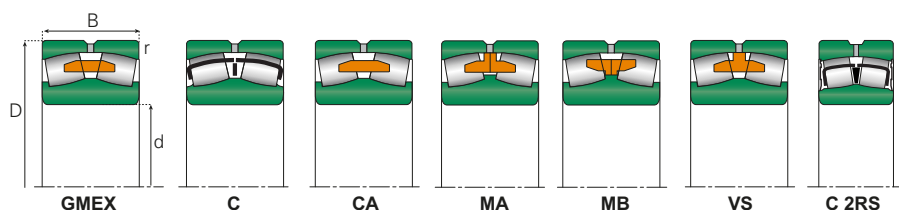

Part number	Principal dimensions			Basic load ratings		Speed limits		Weight Kg	Radius rs min mm	Calculation factors				
	Bore d	Outer D	Width B	Dynamic C	Static Co	Grease rpm	Oil rpm			e	Y1	Y2	Yo	
	mm			kN		1 min <sup>-1</sup>				mm				
238/1000 CA	1000	1220	165	4400	13600	125	160	402	6,0	0,11	5,92	8,81	5,78	
249/1000 CA	1000	1320	315	10200	29200	125	160	1220	7,5	0,21	3,20	4,80	3,20	
230/1000 CA	1000	1420	308	12700	30500	130	175	1590	7,5	0,19	3,60	5,30	3,60	
240/1000 CA	1000	1420	412	15200	40500	110	150	2130	7,5	0,26	2,60	3,90	2,50	
231/1000 CA	1000	1580	462	21500	48200	95	130	3520	12	0,28	2,40	3,50	2,50	
241/1000 CA	1000	1580	580	26500	62200	85	110	4350	12	0,35	1,90	2,90	1,80	
238/1060 CA	1060	1280	165	4700	14800	150	195	440	6,0	0,11	6,10	9,10	6,30	
248/1060 CA	1060	1280	218	6000	19500	125	160	576	6,0	0,14	4,80	7,20	4,50	
239/1060 CA	1060	1400	250	9350	25000	145	170	1041	7,5	0,16	4,20	6,30	4,00	
249/1060 CA	1060	1400	335	11000	32600	115	150	1420	7,5	0,21	3,20	4,80	3,20	
230/1060 CA	1060	1500	325	13500	33000	125	160	2300	9,5	0,19	3,60	5,30	3,60	
240/1060 CA	1060	1500	438	17000	46000	100	145	2530	9,5	0,26	2,60	3,90	2,50	
248/1120 CA	1120	1360	243	7150	23500	105	165	740	6,0	0,15	4,50	6,70	4,50	
249/1120 CA	1120	1460	335	12000	35200	90	135	1500	7,5	0,20	3,40	5,00	3,20	
230/1120 CA	1120	1580	345	15000	38100	90	125	2210	9,5	0,19	3,40	5,00	3,20	
240/1120 CA	1120	1580	462	18100	49500	90	125	2940	9,5	0,26	2,60	3,90	2,50	
238/1180 CA	1180	1420	180	5600	18000	150	190	577	6,0	0,11	6,28	9,35	6,14	
248/1180 CA	1180	1420	243	7700	27200	135	160	790	6,0	0,14	4,80	7,20	4,50	
239/1180 CA	1180	1540	272	10290	29600	110	150	1350	7,5	0,16	4,20	6,30	4,00	
249/1180 CA	1180	1540	355	13310	40000	110	150	1772	7,5	0,20	3,42	5,09	3,34	
230/1180 CA	1180	1660	355	10290	29600	110	150	2460	9,5	0,20	3,42	5,09	3,34	
230/1250 CA	1250	1750	375	17500	44800	95	125	2850	9,5	0,19	3,60	5,30	3,60	
248/1320 CA	1320	1600	280	9750	33400	85	115	1180	6,0	0,15	4,50	6,70	4,50	
249/1320 CA	1320	1720	400	16000	49200	80	105	2510	7,5	0,21	3,20	4,80	3,20	
240/1320 CA	1320	1850	530	23200	63300	70	85	4540	12	0,25	2,70	4,00	2,60	
249/1400 CA	1400	1820	425	20000	58500	70	85	2920	9,5	0,20	3,42	5,09	3,34	
248/1500 CA	1500	1820	315	12000	40000	65	83	1730	7,5	0,15	4,50	6,70	4,50	
248/1800 CA	1800	2180	375	17400	62800	62	70	2920	9,5	0,15	4,50	6,70	4,50	

Index other bore sizes

BEARING STEEL 100Cr6

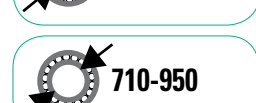
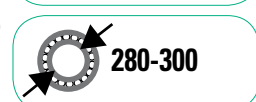



Deep Groove Ball Bearing	Self-Aligning Ball Bearing	Angular Contact Ball Bearing	
Cylindrical Roller Bearing	Tapered Roller Bearing	Spherical Roller Bearing	
<b>Thrust Ball Bearing</b>	Spherical Roller Thrust Bearing	Accessories Adapter & Withdrawal Sleeve	Technical & Related Information



# 5 0 0 1 0 a

## Thrust Ball Bearing

### Introduction



Click here for  
Technical & Related  
Information

Thrust ball bearings are available in single and double acting versions. They sustain axial loads only, and therefore should not be used where radial loads are present.

The thrust loading should not drop below a minimum axial load, maintaining contact between the balls and the track when centrifugal forces are present.

They are manufactured in the following series: 511, 512, 513, 514, 522, 523 and 524.

Dimensions in accordance with ISO 104-2002

Single-acting thrust ball bearings

Single acting thrust ball bearings are used to carry thrust loads in only one direction and cannot carry radial loads. They are made up of a shaft washer, a flat housing washer and a ball and cage assembly. These bearings can be easily mounted by separately fitting each washer.

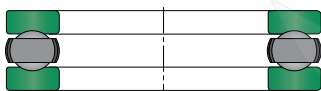

Prefix  
511, 512, 513, 514

Double-acting thrust ball bearing

These bearings can carry thrust loadings in both directions. They are fitted with an extra thrust washer and two ball and cage assemblies. See technical section for further information.

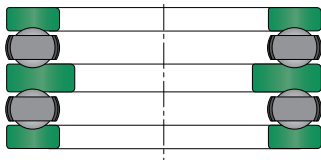

Prefix  
522, 523, 524

Minimum load

The thrust ball bearing requires a minimum axial load, so that the rolling elements maintain rolling contact and sliding is minimized. "Fam" can be obtained from formula:

$$F_{am} = M \left[ \frac{n \text{ Max}}{1000} \right]^2 \text{ [N]}$$

where:

- Fam = minimum thrust load (N)
- M = Factor for minimum load
- n = speed in RPM



Deep Groove Ball Bearing	Self-Aligning Ball Bearing	Angular Contact Ball Bearing	
Cylindrical Roller Bearing	Tapered Roller Bearing	Spherical Roller Bearing	
<b>Thrust Ball Bearing</b>	Spherical Roller Thrust Bearing	Accessories Adapter & Withdrawal Sleeve	Technical & Related Information

# 50100a

## Single Row Thrust Ball Bearing



Click here for  
Technical & Related  
Information

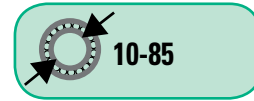
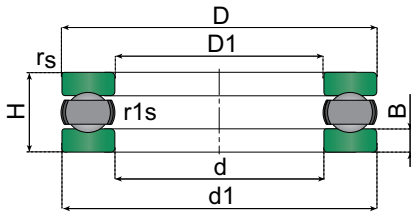

Part number	Principal dimensions			Basic load ratings		Speed limits		Weight Kg	Radius rs min mm	Dimensions				
	Bore	Outer	Height	Dynamic	Static	Grease	Oil			D1	d1	M		
	d	D	H	C	Co	rpm				mm				
mm											kN		1 min <sup>-1</sup>	
51100	10	24	9	10,0	14,0	6300	9000	0,02	0,3	11	24	0,001		
51101	12	26	9	10,2	15,2	6000	8500	0,02	0,3	13	26	0,001		
51201	12	28	11	13,2	19,0	5300	7500	0,03	0,6	14	28	0,002		
51102	15	28	9	10,5	16,8	5600	8000	0,02	0,3	16	28	0,001		
51202	15	32	12	16,5	24,8	4800	6700	0,04	0,6	17	32	0,004		
51103	17	30	9	10,8	18,2	5300	7500	0,02	0,5	18	30	0,002		
51203	17	35	12	17,0	27,2	4500	6800	0,05	0,6	19	35	0,004		
51104	20	35	10	14,2	24,5	4800	6700	0,04	0,3	21	35	0,003		
51204	20	40	14	22,2	37,5	3800	5300	0,08	0,6	22	40	0,008		
51105	25	42	11	15,2	30,2	4300	6000	0,06	1,0	26	42	0,005		
51205	25	47	15	27,8	50,5	3400	4300	0,11	0,6	27	47	0,013		
51305	25	52	18	35,5	61,5	3000	4300	0,17	1,0	27	52	0,019		
51106	30	47	11	16,0	34,2	4000	5600	0,06	0,6	32	47	0,007		
51206	30	52	16	28,0	54,2	3200	4500	0,13	0,6	32	52	0,014		
51306	30	60	21	42,8	78,5	2400	3600	0,26	1,0	32	60	0,028		
51107	35	52	12	18,2	41,5	3800	5300	0,08	0,6	37	52	0,009		
51207	35	62	18	39,2	78,2	2800	4000	0,21	1,0	37	62	0,028		
51307	35	68	24	55,2	105,0	2000	3200	0,37	1,0	37	68	0,050		
51108	40	60	13	26,8	62,8	3400	4800	0,11	0,6	42	60	0,016		
51208	40	68	19	44,8	91,8	2400	3600	0,26	1,5	42	68	0,050		
51308	40	78	26	69,2	135,0	1900	3000	0,53	1,0	42	78	0,080		
51109	45	65	14	27,0	66,0	3200	4500	0,14	0,6	47	65	0,020		
51209	45	73	20	47,8	105,0	2200	3400	0,30	1,0	47	73	0,043		
51309	45	85	28	75,8	150,0	1700	2600	0,66	1,0	47	85	0,120		
51110	50	70	14	27,2	69,2	3000	4300	0,15	0,6	52	70	0,024		
51210	50	78	22	48,5	112,0	2000	3200	0,37	1,0	52	78	0,070		
51310	50	95	31		202,0	1600	2400	0,92	1,1	52	95	0,180		
51111	55	78	16	33,8	89,2	2800	4000	0,22	1,0	57	78	0,038		
51211	55	90	25	67,5	158,0	1900	3000	0,58	1,0	57	90	0,110		
51311	55	105	35	115,0	242,0	1500	2200	1,28	1,1	57	105	0,260		
51112	60	85	17	40,2	108,0	2600	3800	0,27	1,0	62	85	0,053		
51212	60	95	26	73,5	178,0	1800	2800	0,66	1,0	62	95	0,120		
51312	60	110	35	118,0	262,0	1400	2000	1,37	1,1	62	110	0,280		
51113	65	90	18	40,5	112,0	2400	3600	0,31	1,0	67	90	0,060		
51213	65	100	27	74,8	188,0	1700	2600	0,72	1,0	67	100	0,140		
51313	65	115	36	115,0	262,0	1300	1900	1,18	1,1	67	115	0,320		
51114	70	95	18	40,8	115,0	2200	3400	0,33	1,5	72	95	0,067		
51214	70	105	27	73,5	188,0	1600	2400	0,75	1,0	72	105	0,160		
51314	70	125	40	148,0	340,0	1200	1800	1,98	1,1	72	125	0,530		
51115	75	100	19	48,2	140,0	2000	3200	0,38	1,0	77	100	0,095		
51215	75	110	27	74,8	198,0	1500	2200	0,82	1,0	77	110	0,180		
51315	75	135	44	162,0	380,0	1100	1700	2,58	1,5	77	135	0,750		
51116	80	105	19	48,5	145,0	1900	3000	0,40	1,0	82	105	0,100		
51216	80	115	28	83,8	222,0	1400	2000	0,90	1,0	82	115	0,220		
51316	80	140	44	160,0	380,0	1000	1600	2,69	1,5	82	140	0,800		
51117	85	110	19	49,2	150,0	1800	2800	0,42	1,0	87	110	0,120		
51217	85	125	31	102,0	280,0	1300	1900	1,21	1,0	88	125	0,180		
51317	85	150	49	208,0	495,0	950	1500	3,47	1,5	88	150	1,100		

Index other bore sizes

BEARING STEEL 100Cr6

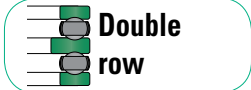





Deep Groove Ball Bearing	Self-Aligning Ball Bearing	Angular Contact Ball Bearing	
Cylindrical Roller Bearing	Tapered Roller Bearing	Spherical Roller Bearing	
<b>Thrust Ball Bearing</b>	Spherical Roller Thrust Bearing	Accessories Adapter & Withdrawal Sleeve	Technical & Related Information

# 50100b

## Single Row Thrust Ball Bearing



Click here for Technical & Related Information

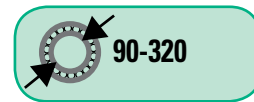
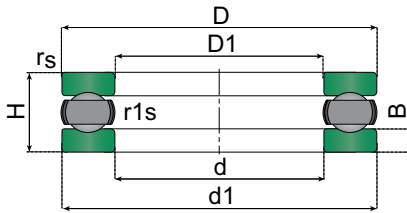

Part number	Principal dimensions			Basic load ratings		Speed limits		Weight	Radius	Dimensions			
	Bore	Outer	Height	Dynamic	Static	Grease	Oil			rs min	D1	d1	M
	d	D	H	C	Co	rpm							
mm			kN		1 min <sup>-1</sup>		Kg	mm					
51118	90	120	22	65,0	200,0	1700	2600	0,65	1,0	92	120	0,190	
51218	90	135	35	115,0	315,0	1200	1800	1,65	1,1	93	135	0,530	
51318	90	155	50	205,0	495,0	900	1400	3,69	1,5	93	155	1,200	
51120	100	135	25	85,0	268,0	1600	2400	0,95	1,0	102	135	0,360	
51220	100	150	38	132,0	375,0	1100	1700	2,21	1,1	103	150	0,670	
51320	100	170	55	235,0	595,0	800	1200	4,86	1,5	103	170	1,800	
51122	110	145	25	87,0	288	2500	2200	1,03	1,0	112	145	0,430	
51222	110	160	38	138,0	412	2000	1600	2,39	1,1	113	160	0,800	
51224M	120	170	39	135,0	412	950	1500	2,62	1,1	123	170	0,480	
51324 M	120	210	70	347,0	977	800	1100	10,71	2,1	123	205	1,000	
51126 M	130	170	30	111,0	316	1400	1900	1,86	1,0	170	170	0,750	
51226 M	130	190	45	212,0	620	950	1400	4,44	1,5	133	187	1,700	
51128 M	140	180	31	107,0	377	1300	1800	0,90	2,0	142	178	0,850	
51228 M	140	200	46	215,0	669	950	1400	2,00	4,5	143	197	1,900	
51130 M	150	190	31	109,0	402	1200	1700	1,00	2,2	152	188	0,900	
51230 M	150	215	50	257,0	795	900	1300	5,21	5,6	153	212	2,800	
51330 M	150	250	80	377,0	1200	670	900	9,00	15,7	154	245	9,000	
51430 M	150	300	120	668,0	2242	-	650	42,00	4,0	154	295	20,000	
51132 M	160	200	31	112,0	427	1200	1700	1,00	2,3	162	198	1,000	
51232 M	160	225	51	247,0	803	850	1200	3,20	6,5	163	222	3,200	
51134 M	170	215	34	134,0	512	1100	1600	1,40	3,3	172	213	1,400	
51234 M	170	240	55	269,0	874	800	1100	4,50	8,1	173	237	4,500	
51334 M	170	280	87	463,0	1570	600	800	13,00	22,0	174	275	13,000	
51136 M	180	225	34	135,0	528	1000	1500	1,50	3,4	183	222	1,500	
51236 M	180	250	56	294,0	986	800	1100	5,00	8,7	183	247	5,000	
51336 M	180	300	95	463,0	1580	560	750	28,10	3,0	184	295	18,000	
51138 M	190	240	37	170,0	657	950	1400	2,40	4,0	193	237	2,400	
51238 M	190	270	62	357,0	1019	750	1000	11,00	2,0	194	267	8,400	
51338 M	190	320	105	607,0	1662	700	800	33,50	4,0	195	315	30,000	
51140 M	200	250	37	169,0	602	950	1400	2,40	4,2	203	247	2,400	
51240 M	200	280	62	333,0	1207	750	1000	8,00	12,5	204	275	8,000	
51144 M	220	270	37	177,0	739	900	1300	3,00	4,7	223	267	3,000	
51244 M	220	300	63	342,0	1308	700	950	9,50	13,5	224	295	9,500	
51148 M	240	300	45	230,0	91	850	1200	5,00	7,5	243	297	5,000	
51248 M	240	340	78	463,0	1889	600	800	18,00	23,5	244	335	18,000	
51152 M	260	320	45	236,0	984	750	1000	5,60	8,1	263	317	5,600	
51252 M	260	360	79	473,0	1967	560	750	22,00	25,5	264	355	22,000	
51156 M	280	350	53	337,0	1435	700	950	10,00	12,0	283	347	10,000	
51256 M	280	380	80	506,0	2168	560	750	24,00	27,5	284	375	24,000	
51160 M	300	380	62	400,0	1530	630	850	14,00	17,5	304	376	14,000	
51260 M	300	420	95	625,0	2872	480	630	40,00	43,0	304	415	40,000	
51164 M	320	400	63	390,0	1580	600	800	16,00	19,0	324	396	16,000	

Index other bore sizes

BEARING STEEL 100Cr6

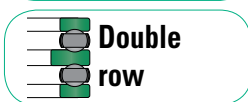



Deep Groove Ball Bearing	Self-Aligning Ball Bearing	Angular Contact Ball Bearing	
Cylindrical Roller Bearing	Tapered Roller Bearing	Spherical Roller Bearing	
<b>Thrust Ball Bearing</b>	Spherical Roller Thrust Bearing	Accessories Adapter & Withdrawal Sleeve	Technical & Related Information



### 50100C

## Double Row Thrust Ball Bearing

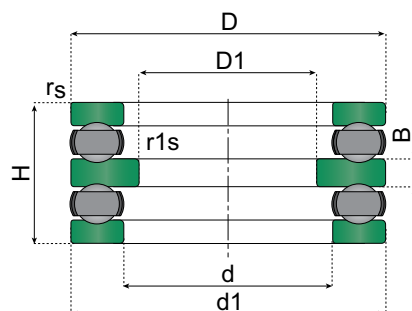

Click here for Technical & Related Information

[Index other bore sizes](#)

**BEARING STEEL 100Cr6**

**Single row**

Part number	Principal dimensions			Basic load ratings		Speed limits		Weight	Radius		Dimensions	
	Bore	Outer	Height	Dynamic	Static	Grease	Oil		rs min	r1s min	D1	B
	d	D	H	C	Co	rpm			mm		mm	
	mm			kN		1 min <sup>-1</sup>		Kg				
52202	10	32	22	17	25	5000	6700	0,09	0,6	0,3	17	5
52204	15	40	26	22	38	4300	5600	0,15	0,6	0,3	22	6
52405	15	60	45	56	89	2600	3600	0,63	1,0	0,3	27	11
52205	20	47	28	28	50	3800	5000	0,23	0,6	0,3	27	7
52305	20	52	34	36	61	3200	4300	0,33	1,0	0,3	27	8
52406	20	70	52	73	126	2000	3000	1,00	1,0	0,6	32	12
52206	25	52	29	28	54	3600	4800	0,27	0,6	0,3	32	7
52306	25	60	38	43	79	2800	3800	0,49	1,0	0,3	32	9
52407	25	80	59	87	155	1800	2600	1,44	1,1	0,6	37	14
52207	30	62	34	41	84	3000	4000	0,42	1,0	0,3	37	8
52208	30	68	36	47	98	2800	3800	0,54	1,0	0,6	42	9
52307	30	68	44	56	105	2400	3400	0,71	1,0	0,3	37	10
52308	30	78	49	69	135	2000	3000	1,06	1,0	0,6	42	12
52408	30	90	65	113	205	1700	2400	2,08	1,1	0,6	42	15
52209	35	73	37	48	105	2600	3600	0,62	1,0	0,6	47	9
52309	35	85	52	81	163	1900	2800	1,29	1,0	0,6	47	12
52409	35	100	72	130	242	1600	2200	2,71	1,1	0,6	47	17
52210	40	78	39	49	111	2400	3400	0,71	1,0	0,6	52	9
52310	40	95	58	92	186	1800	2600	1,86	1,1	0,6	52	14
52410	40	110	78	148	283	1500	2000	3,56	1,5	0,6	52	18
52211	45	90	45	69	159	1900	2800	1,12	1,0	0,6	57	10
52311	45	105	64	119	246	1600	2200	2,51	1,1	0,6	57	15
52411	45	120	87	178	359	1300	1800	4,70	1,5	0,6	57	20
52212	50	95	46	74	179	1900	2800	1,25	1,0	0,6	62	10
52312	50	110	64	124	267	1600	2200	2,68	1,1	0,6	62	15
52412	50	130	93	201	397	1100	1600	6,33	1,5	0,6	62	21
52413	50	140	101	232	493	1000	1500	8,03	2,0	1,0	68	23
52213	55	100	47	75	189	1800	2600	1,36	1,0	0,6	67	10
52214	55	105	47	74	189	1800	2600	1,48	1,0	1,0	72	10
52313	55	115	65	128	287	1500	2000	2,90	1,1	0,6	67	15
52314	55	125	72	148	339	1400	1900	3,90	1,1	1,0	72	16
52215	60	110	47	77	209	1700	2400	1,57	1,0	1,0	77	10
52315	60	135	79	171	396	1200	1700	4,83	1,5	1,0	77	18
52216	65	115	48	79	218	1700	2400	1,69	1,0	1,0	82	10
52316	65	140	79	176	424	1200	1700	5,06	1,5	1,0	82	18
52217	70	125	55	92	251	1600	2200	2,34	1,0	1,0	88	12
52317	70	150	87	206	489	1100	1600	6,43	1,5	1,0	88	19
52218	75	135	62	117	326	1500	2000	3,22	1,1	1,0	93	14
52318	75	155	88	213	524	1000	1500	6,60	1,5	1,0	93	19
52420	80	210	150	368	983	700	950	26,60	2,0	1,0	103	33
52220	85	150	67	147	410	1300	1800	4,29	1,1	1,0	103	15
52320	85	170	97	236	596	950	1400	8,90	1,5	1,0	103	21
52322	95	90	110	280	754	850	1200	13,80	2,0	1,0	113	24
52222	95	160	67	148	431	1200	1700	4,68	1,1	1,0	113	15
52224	100	170	68	154	472	1100	1600	5,24	1,1	1,1	123	15
52324	100	210	123	325	931	800	1100	17,20	2,1	1,1	123	27
52226	110	190	80	203	622	950	1400	7,74	1,5	1,1	133	18
52228M	120	200	81	215	669	950	1400	8,95	1,5	1,1	143	18
52230M	130	215	89	244	768	900	1300	10,60	1,5	1,1	153	20
52330M	130	250	140	377	1200	670	900	27,10	2,1	1,1	154	31
52232M	140	225	90	247	803	850	1200	12,20	1,5	1,1	163	20
62332M	140	250	140	470	1570	630	850	26,20	2,1	1,1	154	31
52234M	150	240	97	269	874	800	1100	15,20	1,5	1,1	173	21



Deep Groove Ball Bearing	Self-Aligning Ball Bearing	Angular Contact Ball Bearing	
Cylindrical Roller Bearing	Tapered Roller Bearing	Spherical Roller Bearing	
Thrust Ball Bearing	<b>Spherical Roller Thrust Bearing</b>	Accessories Adapter & Withdrawal Sleeve	Technical & Related Information



# 5 5 0 1 0 a

## Spherical Roller Thrust Bearing

### Introduction

These bearings are designed to accommodate heavy thrust loads. Due to raceways being inclined to the bearings axis, they can also accommodate radial loads up to a maximum of 55% of the thrust load and are suitable for taking high thrust loads at relatively high speed. Misalignment varies per series; figures are shown below.



Click here for  
Technical & Related  
Information

Dimensions in accordance with ISO 104-2002

Series	Misalignment
292	2°
293	2.5°
294	3°



The bearings are fitted with asymmetrical barrel-shaped rollers. Dimensions conform to ISO 104-2002. In general, lubrication of these bearings should be with oil except in certain exceptional cases. It is also essential that a minimum thrust load be present to avoid damage to the raceways by centrifugal forces (see formula below).

$$F_{a \text{ min}} = \frac{1.5 \text{ cor}}{1000} \quad [\text{KN}]$$

where:

Fa min = minimum thrust load [KN]

Cor = static capacity [KN]

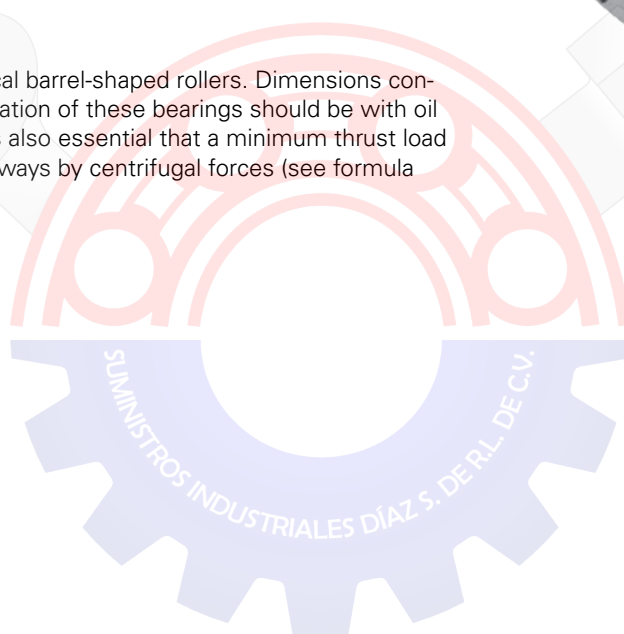
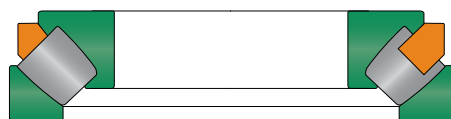



Deep Groove Ball Bearing	Self-Aligning Ball Bearing	Angular Contact Ball Bearing	
Cylindrical Roller Bearing	Tapered Roller Bearing	Spherical Roller Bearing	
Thrust Ball Bearing	<b>Spherical Roller Thrust Bearing</b>	Accessories Adapter & Withdrawal Sleeve	Technical & Related Information



Click here for Technical & Related Information

### 55100a

## Spherical Roller Thrust Bearing

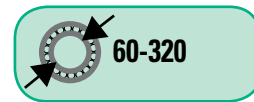
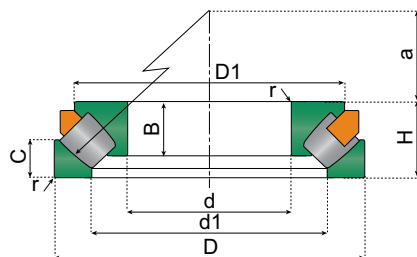

Part number	Principal dimensions			Basic load ratings		Speed limits		Weight	Radius	Dimensions									
	Bore	Outer	Height	Dynamic	Static	Grease	Oil			d	D1	B	C	a					
	d	D	H	C	Co	rpm		Kg	rs min	mm									
													1 min <sup>-1</sup>						
													mm						
29412 EM	60	130	42	364,5	9672	1650	2200	2,75	1,5	85,0	115	34	20,5	38					
29413 EM	65	140	45	418,2	1126	1550	2200	3,41	2	91,5	125	36	21,9	42					
29414 EM	70	150	48	467	1344	1450	2000	4,1	2	99,5	135	38,5	23,4	44					
29415 EM	75	160	51	546	1522	1450	1800	4,98	2	106,0	140	40,5	25	47					
29416 EM	80	170	54	610	1722	1450	1800	5,95	2,1	112,5	150	43,6	26	50					
29317 EM	85	150	39	300	1050	1500	2000	2,87	1,5	110,0	135	31	19,4	50					
29417 EM	85	180	58	653	1815	1200	1600	7,19	2,1	119,5	160	46	27,5	54					
29318 EM	90	155	39	370	1139	1500	2000	3,06	1,5	115,5	140	31	19,8	52					
29418 EM	90	190	60	747	2147	1200	1600	8,28	2,1	125,5	170	48,7	29,3	56					
29320 EM	100	170	42	440	1400	1400	1800	3,91	1,5	127,5	155	32,5	21,2	58					
29420 EM	100	210	67	883	2552	1000	1400	11,2	3	141,0	185	53	32,2	62					
29322 EM	110	190	48	542	1740	1200	1600	5,67	2	141,5	175	37	23,9	64					
29422 EM	110	230	73	1048	3079	900	1200	14,7	3	154,0	205	57	35,1	69					
29324 EM	120	210	54	685	2230	1000	1400	7,96	2,1	155,0	190	41	27,2	70					
29424 EM	120	250	78	1191	3566	900	1200	18,5	4	168,0	220	61	38,8	74					
29326 EM	130	225	58	770	2520	900	1400	9,45	2,1	167,0	205	44,5	28,3	76					
29426 EM	130	270	85	1382	4160	780	1100	23,6	4	181,0	240	66,5	41,1	81					
29328 EM	140	240	60	868	2940	850	1200	11,2	2,1	178,0	220	46,5	29,6	82					
29428 EM	140	280	85	1433	4436	780	1000	24,6	4	192,5	250	66,5	41,4	86					
29330 EM	150	250	60	884	3065	850	1200	11,7	2,1	188,0	230	46	30	87					
29430 EM	150	300	90	1624	5111	700	1000	29,6	4	205,0	270	70	44,3	92					
29332 EM	160	270	67	1021	3486	800	1100	15,5	3	204,0	245	51	33	92					
29432 EM	160	320	95	1750	5330	680	900	35,9	5	218,5	285	74	46,9	99					
29234 EM	170	240	42	439	1760		1600	5,54	1,5	199,0	225	32	20	92					
29334 EM	170	280	67	1044	3644	800	1000	16,3	3	214,5	255	51	32,9	96					
29434 EM	170	340	103	2062	6585	630	850	44	5	233,0	305	79,5	50,8	104					
29236 EM	180	250	42	420	2010	750	1300	7,05	1,5	208,0	236	32	22	96					
29336 EM	180	300	73	1244	4387		1000	20,7	3	227,5	275	55,2	35,8	103					
29436 EM	180	360	109	2275	7317	1760	5500	52,2	5	247,5	320	84,5	52,5	110					
29238 EM	190	270	48	518	2460		1300	7,95	2	220,0	255	36	25,4	102					
29338 EM	190	320	78	1398	4955	580	760	25,5	4	240,0	295	59,5	39,2	110					
29438 EM	190	380	115	2527	8205	750	800	61,4	5	260,5	340	88	56,3	117					
29240 EM	200	280	48	546	2518		1300	9,08	2	230,0	263	39	24	108					
29340 EM	200	340	85	1582	5566	650	800	32	4	253,5	310	64	42,7	116					
29440 EM	200	400	122	2785	9070	550	760	73	5	275,0	360	93,5	59	122					
29244 EM	220	300	48	694	2974		1200	9,84	2	249,5	285	36	25,4	117					
29344 EM	220	360	85	1608	5822	650	800	34,5	4	275,0	330	64	42,6	125					
29444 EM	220	420	122	2870	9634	500	680	74,2	6	275,0	360	93,5	59	122					
29248 EM	240	340	60	977	4077		1000	17,1	2,1	278,0	320	44	31,7	130					
29348 EM	240	380	85	1700	6412	630	800	36,3	4	297,0	350	64	42,1	135					
29448 EM	240	440	122	2978	10298	500	630	83	6	316,0	400	93,5	60,1	142					
29252 EM	260	360	60	1050	4598		1000	18,5	2,1	300,5	340	45,5	30,4	139					
29352 EM	260	420	95	2110	8050	550	710	51,5	5	323,0	385	71,8	48,2	148					
29452 EM	260	480	132	3200	12375	450	630	106	6	342,5	435	102	64,8	154					
29256 EM	280	380	60	1050	4598		900	19,5	2,1	321,0	360	45	31	150					
29356 EM	280	440	95	2220	8767	550	710	54	5	343,0	405	71,8	48	158					
29456 EM	280	520	145	4131	14645	430	560	137	6	370,5	470	110	72,4	166					
29260 EM	300	420	73	1466	6488		710	31	3	348,0	395	54,5	36,4	162					
29360 EM	300	480	109	2682	10400	500	700	69,6	5	370,5	440	81	55,9	168					
29460 EM	300	540	145	4250	15449	400	500	146	6	392,0	490	110	72,4	175					
29264 EM	320	440	73	1521	6893		630	32,8	3	368,5	415	54	37,4	172					
29364 EM	320	500	109	2833	11360	450	560	80	5	391,5	465	81	55,2	180					
29464 EM	320	580	155	4917	18167	380	500	179	7,5	417,5	525	118,5	76,7	191					

Index other bore sizes

BEARING STEEL 100Cr6





Deep Groove Ball Bearing	Self-Aligning Ball Bearing	Angular Contact Ball Bearing	
Cylindrical Roller Bearing	Tapered Roller Bearing	Spherical Roller Bearing	
Thrust Ball Bearing	<b>Spherical Roller Thrust Bearing</b>	Accessories Adapter & Withdrawal Sleeve	Technical & Related Information

# 5 5 1 0 0 b

## Spherical Roller Thrust Bearing



Click here for Technical & Related Information

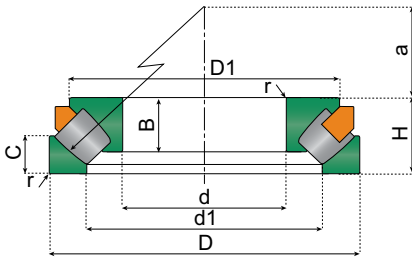

Index other bore sizes

BEARING STEEL 100Cr6



Part number	Principal dimensions			Basic load ratings		Speed limits		Weight	Radius	Dimensions					
	Bore	Outer	Height	Dynamic	Static	Grease	Oil			d	D1	B	C	a	
	d	D	H	C	Co	rpm		Kg	rs min	mm					
	mm			kN		1 min <sup>-1</sup>			mm						
29268 EM	340	460	73	1570	7304		630	34,5	3	389,0	435	54,5	36,5	183	
29368 EM	340	540	122	3373	13425	400	500	106	5	419,5	500	90,5	60,6	192	
29468 EM	340	620	170	5504	20070	340	450	228	7,5	446,0	560	128	84,5	201	
29272 EM	360	500	85	1989	9084		560	50,4	4	417,0	475	63	42,7	194	
29372 EM	360	560	122	3442	13990		500	140	5	440,0	520	91	60,8	202	
29472 EM	360	640	170	5682	21212		450	234	7,5	467,5	580	129	83,1	210	
29276 EM	380	520	85	2002	9307		560	52,8	4	437,5	490	65	43,1	202	
29376 EM	380	600	132	3962	16164		500	140	6	466,0	555	98,5	66,9	216	
29476 EM	380	670	175	6025	22737		430	263	7,5	490,5	610	130	85,9	230	
29280 EM	400	540	85	2065	9839		700	55,1	4	457,5	510	63,3	42,6	212	
29380 EM	400	620	132	4040	16810		450	146	6	487,5	575	98	66,9	225	
29480 EM	400	710	185	6757	25820		380	314	7,5	517,5	645	140	94	236	
29284 EM	420	580	95	2536	12067		560	74,9	5	483,5	550	72	49,7	225	
29384 EM	420	650	140	4434	18466		420	170	6	512,5	600	103,5	70,7	235	
29484 EM	420	730	185	6969	27200		370	325	7,5	538,0	665	142	92,1	244	
29288 EM	440	600	95	2618	12747		560	79	5	503,5	570	72	49,6	235	
29388 EM	440	680	145	4757	20018		400	192	6	536,5	630	108	73,7	245	
29488 EM	440	780	206	8073	31032		350	421	9,5	570,0	710	152	105	260	
29292 EM	460	620	95	2644	13085		500	80,9	5	524,5	590	72	49,4	245	
29392 EM	460	710	150	5205	22264		400	216	6	558,5	660	112	76,6	257	
29492 EM	460	800	206	8325	32668		350	435	9,5	592,5	730	149	107	272	
29296 EM	480	650	103	2982	14620		480	98	5	549,0	620	76,5	52,1	259	
29396 EM	480	730	150	5214	22550		400	224	6	579,5	675	112	76	270	
29496 EM	480	850	224	9419	36691		320	534,2	9,5	623,0	770	166,5	111,8	280	
292/500 EM	500	670	103	3012	14987		450	101	5	569,5	640	76,5	52	268	
293/500 EM	500	750	150	5322	23422		360	231	6	600,0	700	112	76,2	280	
294/500 EM	500	870	224	9520	40000		320	559	9,5	643,0	790	170	109,1	290	
292/530 EM	530	710	109	3356	16859		400	108	5	603,0	675	81	55,2	288	
293/530 EM	530	800	160	6057	26973		320	270	7,5	639,5	745	119,5	81	295	
294/530 EM	530	920	236	10703	42908		300	650	9,5	682,0	840	177	118,5	309	
292/560 EM	560	750	115	3100	8600		350	140	5	640,0	715	84	56,8	302	
293/560 EM	560	850	175	5790	29700		280	320	7,5						
294/560 EM	560	980	250	10210	47800		250	740	12	890,0	727	92	120	328	
292/600 EM	600	800	122	3420	20100		300	172	5	688,0	760	39	60	321	
293/600 EM	600	900	180	6350	32600		250	368	7,5	731,0	870	61	87	335	
294/600 EM	600	1030	258	12730	52273		200	880	12	766,0	940	200	128,7	347	
292/630 EM	630	850	132	4770	24500		250	218	6	728,0	814,5	94	67,3	338	
293/630 EM	630	950	190	7070	37000		200	438	9,5						
294/630 EM	630	1090	280	13700	58200		200	1000	12						
292/670 EM	670	900	140	4900	26000		380	225	6	773,0	855	93	74	364	
293/670 EM	670	1000	200	7720	40300		150	501	9,5						
292/710 EM	710	950	145	4840	29400		-	261	6						
293/710 EM	710	1060	212	8570	45100		-	260	620	9,5	995,0	857,5	150	103,5	724
294/710 EM	710	1220	308	16800	71000		220	1500	15	1130	910	113	148,5	415	
292/750 EM	750	1000	150	5180	31900		200	311	6	854,5	955	108	76	406	
293/750 EM	750	1120	224	9370	50600		250	696	9,5						
294/750 EM	750	1280	315	15000	76000		300	1536	18	972,0	1164	222	158	436	
292/800 EM	800	1060	155	5620	35300		340	339	7,5	1010,0	907,5	50	80	426	
293/800 EM	800	1180	230	10110	54900			780	9,5						
292/850 EM	850	1120	160	6080	38900			389	7,5						
294/850 EM	850	1440	354	28600	100000		150	2090	7,5	1098,0	1330	221	172	494	
292/900 EM	900	1180	170	6590	42000		250	444	7,5	1017,0	1129,5	122	86	477	
292/950 EM	950	1250	180	8430	46900		240	537	7,5	1081,0	1185	58	88	507	





Deep Groove Ball Bearing	Self-Aligning Ball Bearing	Angular Contact Ball Bearing	
Cylindrical Roller Bearing	Tapered Roller Bearing	Spherical Roller Bearing	
Thrust Ball Bearing	Spherical Roller Thrust Bearing	<b>Accessories Adapter &amp; Withdrawal Sleeve</b>	Technical & Related Information

# 6 0 0 1 0 a

## Accessories Adapter & Withdrawal Sleeve

### Introduction



Click here for  
Technical & Related  
Information

Adapter sleeves are used to locate tapered bore bearings on cylindrical shafts. This allows less accurate machining of the shafts and ease of location. Adapter sleeves are available in metric or inch bore sizes - the external taper is 1:12.

See pages from 90100a to 90100m for tolerances.

Hydraulic sleeves are available from 200mm bore diameter. Suffix: OH

Dimensions in accordance with ISO 2982-1995

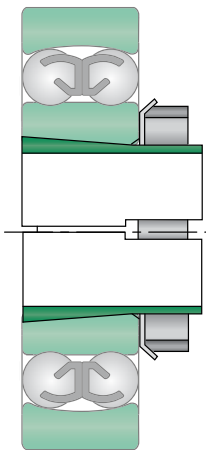

### 6 0 1 0 0 a

Adapter sleeve

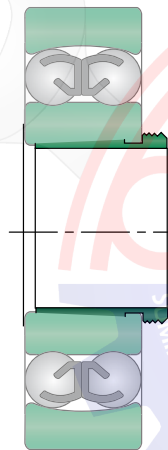

### 6 0 2 0 0 a

Withdrawal sleeve

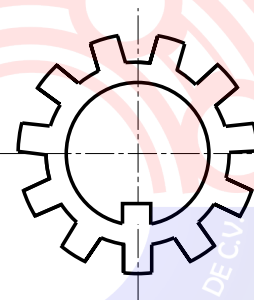

### 6 0 2 5 0 a

Locking device

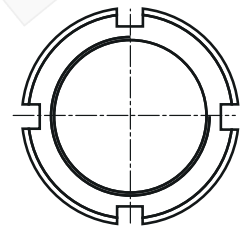

### 6 0 2 5 0 b

Locking nut

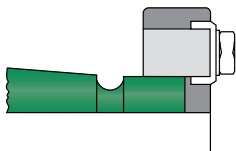

### Adapter sleeves

with bore size 220mm and larger can also be supplied with a locking clip.

Suffix MS



Deep Groove Ball Bearing	Self-Aligning Ball Bearing	Angular Contact Ball Bearing	
Cylindrical Roller Bearing	Tapered Roller Bearing	Spherical Roller Bearing	
Thrust Ball Bearing	Spherical Roller Thrust Bearing	<b>Accessories Adapter &amp; Withdrawal Sleeve</b>	Technical & Related Information



## 60100a

## Adapter Sleeve

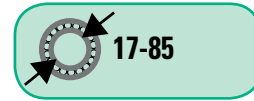
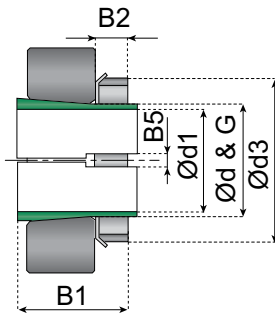

Click here for Technical & Related Information

Taper 1:12

Part number	Principal dimensions						Weight	Accessories included	
	d1	d	d3	B1	B2	G		Locking Nut	Locking Device
	mm						Kg	Part Number	Part Number
H 204	17	20	32	24	7	M 20x1	0,041	KM4	MB4
H 2304	17	20	32	31	7	M 20x1	0,049	KM4	MB4
H 304	17	20	32	28	7	M 20x1	0,045	KM4	MB4
H 205	20	25	38	26	8	M 25x1,5	0,070	KM5	MB5
H 2305	20	25	38	35	8	M 25x1,5	0,087	KM5	MB5
H 305	20	25	38	29	8	M 25x1,5	0,075	KM5	MB5
H 206	25	30	45	27	8	M 30x1,5	0,099	KM6	MB6
H 2306	25	30	45	38	8	M 30x1,5	0,126	KM6	MB6
H 306	25	30	45	31	8	M 30x1,5	0,109	KM6	MB6
H 207	30	35	52	29	9	M 35x1,5	0,125	KM7	MB7
H 2307	30	35	52	43	9	M 35x1,5	0,165	KM7	MB7
H 307	30	35	52	35	9	M 35x1,5	0,142	KM7	MB7
HE 308	31,75	40	58	36	10	M 40x1,5	0,220	KM8	MB8
H 208	35	40	58	31	10	M 40x1,5	0,174	KM8	MB8
H 2308	35	40	58	46	10	M 40x1,5	0,224	KM8	MB8
H 308	35	40	58	36	10	M 40x1,5	0,189	KM8	MB8
H 209	40	45	65	33	11	M 45x1,5	0,227	KM9	MB9
H 2309	40	45	65	50	11	M 45x1,5	0,280	KM9	MB9
H 309	40	45	65	39	11	M 45x1,5	0,248	KM9	MB9
H 210	45	50	70	35	12	M 50x1,5	0,274	KM10	MB10
H 2310	45	50	70	55	12	M 50x1,5	0,362	KM10	MB10
H 310	45	50	70	42	12	M 50x1,5	0,303	KM10	MB10
H 211	50	55	75	37	12,5	M 55x2	0,308	KM11	MB11
H 2311	50	55	75	59	12,5	M 55x2	0,420	KM11	MB11
H 311	50	55	75	45	12,5	M 55x2	0,345	KM11	MB11
H 212	55	60	80	38	13	M 60x2	0,346	KM12	MB12
H 2312	55	60	80	62	13	M 60x2	0,481	KM12	MB12
H 312	55	60	80	47	13	M 60x2	0,394	KM12	MB12
H 213	60	65	85	40	14	M 65x2	0,401	KM13	MB13
H 2313	60	65	85	65	14	M 65x2	0,557	KM13	MB13
H 313	60	65	85	50	14	M 65x2	0,458	KM13	MB13
H 214	60	70	92	41	14	M 70x2	0,593	KM14	MB14
H 2314	60	70	92	68	14	M 70x2	0,897	KM14	MB14
H 314	60	70	92	52	14	M 70x2	0,723	KM14	MB14
H 215	65	75	98	43	15	M 75x2	0,707	KM15	MB15
H 2315	65	75	98	73	15	M 75x2	1,050	KM15	MB15
H 315	65	75	98	55	15	M 75x2	0,831	KM15	MB15
H 216	70	80	105	46	17	M 80x2	0,882	KM16	MB16
H 2316	70	80	105	78	17	M 80x2	1,280	KM16	MB16
H 316	70	80	105	59	17	M 80x2	1,030	KM16	MB16
H 217	75	85	110	50	18	M 85x2	1,020	KM17	MB17
H 2317	75	85	110	82	18	M 85x2	1,450	KM17	MB17
H 317	75	85	110	63	18	M 85x2	1,180	KM17	MB17
H 218	80	90	120	52	18	M 90x2	1,190	KM18	MB18
H 2318	80	90	120	86	18	M 90x2	1,690	KM18	MB18
H 318	80	90	120	65	18	M 90x2	1,370	KM18	MB18
H 219	85	95	125	55	19	M 95x2	1,370	KM19	MB19
H 2319	85	95	125	90	19	M 95x2	1,920	KM19	MB19
H 319	85	95	125	68	19	M 95x2	1,560	KM19	MB19

Index other bore sizes



ACCESSORIES





Deep Groove Ball Bearing	Self-Aligning Ball Bearing	Angular Contact Ball Bearing	
Cylindrical Roller Bearing	Tapered Roller Bearing	Spherical Roller Bearing	
Thrust Ball Bearing	Spherical Roller Thrust Bearing	<b>Accessories Adapter &amp; Withdrawal Sleeve</b>	Technical & Related Information



# 60100b

## Adapter Sleeve

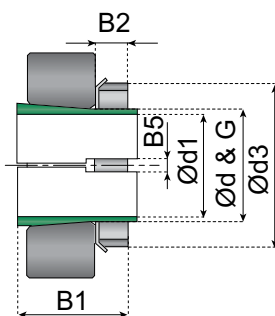

Click here for Technical & Related Information

Taper 1:12

Part number	Principal dimensions						Weight	Accessories included	
	d1	d	d3	B1	B2	G		Locking Nut	Locking Device
	mm						Kg	Part Number	Part Number
H 220	90	100	130	58	20	M 100x2	1,490	KM20	MB20
H 2320	90	100	130	97	20	M 100x2	2,150	KM20	MB20
H 3120	90	100	130	76	20	M 100x2	1,800	KM20	MB20
H 320	90	100	130	71	20	M 100x2	1,690	KM20	MB20
H 221	95	105	140	60	20	M 105x2	1,720	KM21	MB21
H 321	95	105	140	74	20	M 105x2	1,950	KM21	MB21
H 222	100	110	145	63	21	M 110x2	1,930	KM22	MB22
H 2322	100	110	145	105	21	M 110x2	2,740	KM22	MB22
H 3122	100	110	145	81	21	M 110x2	2,250	KM22	MB22
H 322	100	110	145	77	21	M 110x2	2,180	KM22	MB22
H 3024	110	120	145	72	22	M 120x2	1,930	KML24	MBL24
H 2324	110	120	155	112	22	M 120x2	3,190	KM24	MB24
H 3124	110	120	155	88	22	M 120x2	2,640	KM24	MB24
H 3026	115	130	155	80	23	M 130x2	2,850	KML26	MBL26
H 2326	115	130	165	121	23	M 130x2	4,600	KM26	MB26
H 3126	115	130	165	92	23	M 130x2	3,660	KM26	MB26
H 3028	125	140	165	82	24	M 140x2	3,160	KML28	MBL28
H 2328	125	140	180	131	24	M 140x2	5,550	KM28	MB28
H 3128	125	140	180	97	24	M 140x2	4,340	KM28	MB28
H 3030	135	150	180	87	26	M 150x2	3,890	KML30	MBL30
H 2330	135	150	195	139	26	M 150x2	6,630	KM30	MB30
H 3130	135	150	195	111	26	M 150x2	5,520	KM30	MB30
H 3032	140	160	190	93	27,5	M 160x3	5,210	KML32	MBL32
H 2332	140	160	210	147	28	M 160x3	9,140	KM32	MB32
H 3132	140	160	210	119	28	M 160x3	7,670	KM32	MB32
H 3034	150	170	200	101	28,5	M 170x3	5,990	KML34	MBL34
H 2334	150	170	220	154	29	M 170x3	10,200	KM34	MB34
H 3134	150	170	220	122	29	M 170x3	8,380	KM34	MB34
H 3036	160	180	210	109	29,5	M 180x3	6,830	KML36	MBL36
H 3036 OH	160	180	210	109	29,5	M 180x3	6,700	KML36	MBL36
H 3936	160	180	210	87	29,5	M 180x3	5,700	KML36	MBL36
H 2336	160	180	230	161	30	M 180x3	11,300	KM36	MB36
H 2336 OH	160	180	230	161	30	M 180x3	11,000	KM36	MB36
H 3136	160	180	230	131	30	M 180x3	9,500	KM36	MB36
H 3136 OH	160	180	230	131	30	M 180x3	9,150	KM36	MB36
H 3038	170	190	220	112	30,5	M 190x3	7,450	KML38	MBL38
H 3038 OH	170	190	220	112	30,5	M 190x3	7,250	KML38	MBL38
H 3938	170	190	220	89	30,5	M 190x3	6,190	KML38	MBL38
H 2338	170	190	240	169	31	M 190x3	12,600	KM38	MB38
H 2338 OH	170	190	240	169	31	M 190x3	12,000	KM38	MB38
H 3138	170	190	240	141	31	M 190x3	10,800	KM38	MB38
H 3138 OH	170	190	240	141	31	M 190x3	10,500	KM38	MB38
H 3040	180	200	240	120	31,5	M 200x3	9,190	KML40	MBL40
H 3040 OH	180	200	240	120	31,5	M 200x3	8,900	KML40	MBL40
H 3940	180	200	240	98	31,5	M 200x3	7,890	KML40	MBL40
H 2340	180	200	250	176	32	M 200x3	13,900	KM40	MB40
H 2340 OH	180	200	250	176	32	M 200x3	13,500	KM40	MB40
H 3140	180	200	250	150	32	M 200x3	12,100	KM40	MB40
H 3140 OH	180	200	250	150	32	M 200x3	12,000	KM40	MB40

Index other bore sizes



ACCESSORIES



Details part number:  
- Suffixes **OH**: sleeve including oil supply ducts and oil grooves.





Deep Groove Ball Bearing	Self-Aligning Ball Bearing	Angular Contact Ball Bearing	
Cylindrical Roller Bearing	Tapered Roller Bearing	Spherical Roller Bearing	
Thrust Ball Bearing	Spherical Roller Thrust Bearing	<b>Accessories Adapter &amp; Withdrawal Sleeve</b>	Technical & Related Information



# 60100c

## Adapter Sleeve

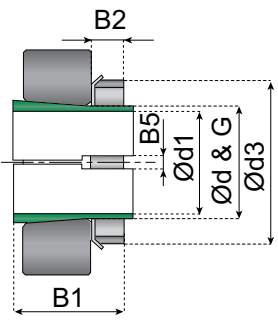

Click here for Technical & Related Information

Taper 1:12

Part number	Principal dimensions						Weight	Accessories included	
	d1	d	d3	B1	B2	G		Locking Nut	Locking Device
	mm						Kg	Part Number	Part Number
H 3044	200	220	260	126	30	M 220x4	10,300	HM3044	MS3044
H 3044 OH	200	220	260	126	30	M 220x4	9,900	HM3044	MS3044
H 3944	200	220	260	96	30	M 220x4	8,160	HM3044	MS3044
H 2344	200	220	280	186	35	M 220x4	17,000	HM44T	MB44
H 2344 OH	200	220	280	186	35	M 220x4	17,000	HM44T	MB44
H 3144	200	220	280	161	35	M 220x4	15,000	HM44T	MB44
H 3144 OH	200	220	280	161	35	M 200x3	15,000	HM44T	MB44
H 3048	220	240	290	133	34	M 240x4	13,200	HM3048	MS3048
H 3048 OH	220	240	290	133	34	M 240x4	12,000	HM3048	MS3052-48
H 3948	220	240	290	101	34	M 240x4	11,000	HM3048	MS3048
H 2348	220	240	300	199	37	M 240x4	20,000	HM48T	MB48
H 2348 OH	220	240	300	199	37	M 240x4	19,000	HM48T	MB48
H 3148	220	240	300	172	37	M 240x4	17,600	HM48T	MB48
H 3148 OH	220	240	300	172	37	M 240x4	16,500	HM48T	MB48

### Index other bore sizes

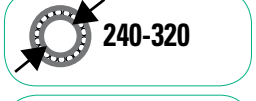

### ACCESSORIES



**Details part number:**  
 - Suffixes **OH**: sleeve including oil supply ducts and oil grooves.





Deep Groove Ball Bearing	Self-Aligning Ball Bearing	Angular Contact Ball Bearing	
Cylindrical Roller Bearing	Tapered Roller Bearing	Spherical Roller Bearing	
Thrust Ball Bearing	Spherical Roller Thrust Bearing	<b>Accessories Adapter &amp; Withdrawal Sleeve</b>	Technical & Related Information



# 60100d

## Adapter Sleeve

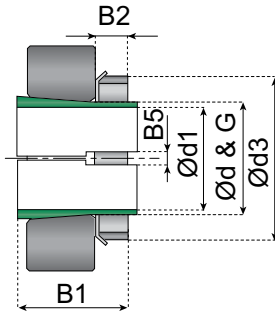

Click here for Technical & Related Information

Taper 1:12

Part number	Principal dimensions						Weight	Accessories excluded	
	d1	d	d3	B1	B2	G		Locking Nut	Locking Device
	mm						Kg	Part Number	Part Number
H 3052	240	260	310	145	34	M 260x4	15,300	HM3052	MS3052
H 3052 OH	240	260	310	145	34	M 260x4	13,500	HM3052	MS3052-48
H 3952	240	260	310	116	34	M 260x4	12,800	HM3052	MS3052
H 2352	240	260	330	211	39	M 260x4	24,500	HM52T	MB52
H 2352 OH	240	260	330	211	39	M 260x4	23,000	HM52T	MB52
H 3152	240	260	330	190	39	M 260x4	22,300	HM52T	MB52
H 3152 OH	240	260	330	190	39	M 260x4	21,000	HM52T	MB52
H 3056	260	280	330	152	38	M 280x4	17,700	HM3056	MS3056
H 3056 OH	260	280	330	152	38	M 280x4	16,000	HM3056	MS3056
H 3156 OH	260	280	330	195	41	M 280x4	19,300	HM3056	MS3056
H 3956	260	280	330	121	38	M 280x4	15,300	HM3056	MS3056
H 2356	260	280	350	224	41	M 280x4	28,400	HM56T	MB56
H 2356 OH	260	280	350	224	41	M 280x4	27,000	HM56T	MB56
H 3156	260	280	350	195	41	M 280x4	25,100	HM56T	MB56
H 3060	280	300	360	168	42	M 300x4	22,800	HM3060	MS3060
H 3060 OH	280	300	360	168	42	M 300x4	20,500	HM3060	MS3060
H 3960	280	300	360	140	42	M 300x4	20,000	HM3060	MS3060
H 3160	280	300	380	208	40	M 300x4	30,200	HM3160	MS3160
H 3160 OH	280	300	380	208	40	M 300x4	29,000	HM3160	MS3160
H 3260	280	300	380	240	40	M 300x4	34,100	HM3160	MS3160
H 3260 OH	280	300	380	240	40	M 300x4	32,000	HM3160	MS3160
H 3064	300	320	380	171	42	M 320x5	24,600	HM3064	MS3064
H 3064 OH	300	320	380	171	42	M 320x5	22,000	HM3064	MS3068-64
H 3964	300	320	380	140	42	M 320x5	21,500	HM3064	MS3064
H 3164	300	320	400	226	42	M 320x5	34,900	HM3164	MS3164
H 3164 OH	300	320	400	226	42	M 320x5	32,000	HM3164	MS3164
H 3264	300	320	400	258	42	M 320x5	39,300	HM3164	MS3164
H 3264 OH	300	320	400	258	42	M 320x5	35,000	HM3164	MS3164
H 3068	320	340	400	187	45	M 340x5	28,700	HM3068	MS3068
H 3068 OH	320	340	400	187	45	M 340x5	27,000	HM3068	MS3068-64
H 3968	320	340	400	144	45	M 340x5	24,500	HM3068	MS3068
H 3168	320	340	440	254	55	M 340x5	50,000	HM3168	MS3168
H 3168 OH	320	340	440	254	55	M 340x5	50,000	HM3168	MS3172-68
H 3268	320	340	440	288	55	M 340x5	54,600	HM3168	MS3168
H 3268 OH	320	340	440	288	55	M 340x5	51,500	HM3168	MS3172-68

Index other bore sizes



ACCESSORIES



Details part number:  
- Suffixes **OH**: sleeve including oil supply ducts and oil grooves.



Deep Groove Ball Bearing	Self-Aligning Ball Bearing	Angular Contact Ball Bearing	
Cylindrical Roller Bearing	Tapered Roller Bearing	Spherical Roller Bearing	
Thrust Ball Bearing	Spherical Roller Thrust Bearing	Accessories Adapter & Withdrawal Sleeve	Technical & Related Information



# 60100e

## Adapter Sleeve

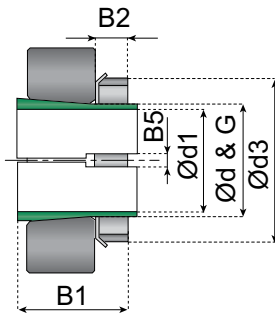

Click here for  
Technical & Related  
Information

### Taper 1:12

Part number	Principal dimensions						Weight	Accessories excluded	
	d1	d	d3	B1	B2	G		Locking Nut	Locking Device
	mm						Kg	Part Number	Part Number
H 3072	340	360	420	188	45	M 360x5	30,500	HM3072	MS3072
H 3072 OH	340	360	420	188	45	M 360x5	29,000	HM3072	MS3072
H 3972	340	360	420	144	45	M 360x5	25,200	HM3072	MS3072
H 3172	340	360	460	259	58	M 360x5	56,000	HM3172	MS3172
H 3172 OH	340	360	460	259	58	M 360x5	56,000	HM3172	MS3172-68
H 3272	340	360	460	299	58	M 360x5	60,600	HM3172	MS3172
H 3272 OH	340	360	460	299	58	M 360x5	60,500	HM3172	MS3172-68
H 3076	360	380	450	193	48	M 380x5	35,800	HM3076	MS3076
H 3076 OH	360	380	450	193	48	M 380x5	35,500	HM3076	MS3080-76
H 3976	360	380	450	164	48	M 380x5	31,500	HM3076	MS3076
H 3176	360	380	490	264	60	M 380x5	61,700	HM3176	MS3176
H 3176 OH	360	380	490	264	60	M 380x5	61,500	HM3176	MS3176
H 3276	360	380	490	310	60	M 380x5	69,600	HM3176	MS3176
H 3276 OH	360	380	490	310	60	M 380x5	69,500	HM3176	MS3176
H 3080	380	400	470	210	52	M 400x5	41,300	HM3080	MS3080
H 3080 OH	380	400	470	210	52	M 400x5	40,000	HM3080	MS3080-76
H 3980	380	400	470	168	52	M 400x5	35,000	HM3080	MS3080
H 3180	380	400	520	272	62	M 400x5	73,000	HM3180	MS3180
H 3180 OH	380	400	520	272	62	M 400x5	73,000	HM3180	MS3184-80
H 3280	380	400	520	328	62	M 400x5	81,000	HM3180	MS3180
H 3280 OH	380	400	520	328	62	M 400x5	87,000	HM3180	MS3184-80
H 3084	400	420	490	212	52	M 420x5	43,700	HM3084	MS3084
H 3084 OH	400	420	490	212	52	M 420x5	47,000	HM3084	MS3084
H 3984	400	420	490	168	52	M 420x5	36,600	HM3084	MS3084
H 3184	400	420	540	304	70	M 420x5	84,200	HM3184	MS3184
H 3184 OH	400	420	540	304	70	M 420x5	80,000	HM3184	MS3184-80
H 3284	400	420	540	352	70	M 420x5	96,000	HM3184	MS3184
H 3284 OH	400	420	540	352	70	M 420x5	96,000	HM3184	MS3184-80
H 3088	410	440	520	228	60	M 440x5	65,200	HM3088	MS3088
H 3088 OH	410	440	520	228	60	M 440x5	65,000	HM3088	MS3092-88
H 3988	410	440	520	189	60	M 440x5	58,000	HM3088	MS3088
H 3188	410	440	560	307	70	M 440x5	104,000	HM3188	MS3188
H 3188 OH	410	440	560	307	70	M 440x5	95,000	HM3188	MS3192-88
H 3288	410	440	560	361	70	M 440x5	118,000	HM3188	MS3188
H 3288 OH	410	440	560	361	70	M 440x5	117,000	HM3188	MS3192-88
H 3092	430	460	540	234	60	M 460x5	71,000	HM3092	MS3092
H 3092 OH	430	460	540	234	60	M 460x5	71,000	HM3092	MS3092-88
H 3992	430	460	540	189	60	M 460x5	60,000	HM3092	MS3092
H 3192	430	460	580	326	75	M 460x5	116,000	HM3192	MS3192
H 3192 OH	430	460	580	326	75	M 460x5	119,000	HM3192	MS3192-88
H 3292	430	460	580	382	75	M 460x5	134,000	HM3192	MS3192
H 3292 OH	430	460	580	382	75	M 460x5	134,000	HM3192	MS3192-88
H 3096	450	480	560	237	60	M 480x5	75,000	HM3096	MS30/96
H 3096 OH	450	480	560	237	60	M 480x5	75,000	HM3096	MS30/500-96
H 3996	450	480	560	200	60	M 480x5	66,000	HM3096	MS30/96
H 3196	450	480	620	335	75	M 480x5	135,000	HM3196	MS3196
H 3196 OH	450	480	620	335	75	M 480x5	135,000	HM3196	MS3196
H 3296	450	480	620	397	75	M 480x5	153,000	HM3196	MS3196
H 3296 OH	450	480	620	397	75	M 480x5	153,000	HM3196	MS3196

Index other bore sizes



ACCESSORIES



**Details part number:**  
- Suffixes **OH**: sleeve including oil supply ducts and oil grooves.



Deep Groove Ball Bearing	Self-Aligning Ball Bearing	Angular Contact Ball Bearing	
Cylindrical Roller Bearing	Tapered Roller Bearing	Spherical Roller Bearing	
Thrust Ball Bearing	Spherical Roller Thrust Bearing	<b>Accessories Adapter &amp; Withdrawal Sleeve</b>	Technical & Related Information



**60100f**

**Adapter Sleeve**

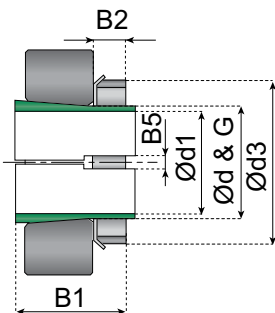

Click here for  
Technical & Related  
Information

**Taper 1:12**

Part number	Principal dimensions						Weight	Accessories excluded	
	d1	d	d3	B1	B2	G		Locking Nut	Locking Device
	mm						Kg	Part Number	Part Number
H 30/500	470	500	580	247	68	M 500x5	82,000	HM30/500	MS30/500
H 30/500 OH	470	500	580	247	68	M 500x5	82,000	HM30/500	MS30/500-96
H 39/500	470	500	580	208	68	M 500x5	74,300	HM30/500	MS30/500
H 31/500	470	500	630	356	80	M 500x5	145,000	HM31/500	MS31/500
H 31/500 OH	470	500	630	356	80	M 500x5	145,000	HM31/500	MS31/500
H 32/500	470	500	630	428	80	M 500x5	166,000	HM31/500	MS31/500
H 32/500 OH	470	500	630	428	80	M 500x5	170,000	HM31/500	MS31/500
H 30/530	500	530	630	265	68	M 530x6	105,000	HM30/530	MS30/530
H 30/530 OH	500	530	630	265	68	M 530x6	105,000	HM30/530	MS30/600-530
H 39/530	500	530	630	216	68	M 530x6	87,900	HM30/530	MS30/530
H 39/530 OH	500	530	630	216	68	M 530x6	87,900	HM30/530	MS30/600-530
H 31/530	500	530	670	364	80	M 530x6	161,000	HM31/530	MS31/530
H 32/530	500	530	670	447	80	M 530x6	192,000	HM31/530	MS31/530
H 30/560	530	560	650	282	75	M 560x6	112,000	HM30/560	MS30/560
H 30/560 OH	530	560	650	282	75	M 560x6	112,000	HM30/560	MS30/560
H 39/560	530	560	650	227	75	M 560x6	95,000	HM30/560	MS30/560
H 39/560 OH	530	560	650	227	75	M 560x6	95,000	HM30/560	MS30/560
H 31/560	530	560	710	377	85	M 560x6	185,000	HM31/560	MS31/560
H 32/560	530	560	710	462	85	M 560x6	219,000	HM31/560	MS31/560
H 30/600	560	600	700	289	75	M 600x6	147,000	HM30/600	MS30/600
H 30/600 OH	560	600	700	289	75	M 600x6	147,000	HM30/600	MS30/600-530
H 39/600	560	600	700	239	75	M 600x6	127,000	HM30/600	MS30/600
H 39/600 OH	560	600	700	239	75	M 600x6	127,000	HM30/600	MS30/600-530
H 31/600	560	600	750	399	85	M 600x6	234,000	HM31/600	MS31/600
H 32/600	560	600	750	487	85	M 600x6	278,000	HM31/600	MS31/600
H 30/630	600	630	730	301	75	M 630x6	138,000	HM30/630	MS30/630
H 30/630 OH	600	630	730	301	75	M 630x6	138,000	HM30/630	MS30/630
H 39/630	600	630	730	254	75	M 630x6	120,000	HM30/630	MS30/630
H 39/630 OH	600	630	730	254	75	M 630x6	124,000	HM30/630	MS30/630
H 31/630	600	630	800	424	95	M 630x6	254,000	HM31/630	MS31/630
H 32/630	600	630	800	521	95	M 630x6	300,000	HM31/630	MS31/630
H 30/670	630	670	780	324	80	M 670x6	191,000	HM30/670	MS30/670
H 30/670 OH	630	670	780	324	80	M 670x6	190,000	HM30/670	MS30/670
H 39/670	630	670	780	264	80	M 670x6	163,000	HM30/670	MS30/670
H 39/670 OH	630	670	780	264	80	M 670x6	162,000	HM30/670	MS30/670
H 31/670	630	670	850	456	106	M 670x6	340,000	HM31/670	MS31/670
H 32/670	630	670	850	558	106	M 670x6	401,000	HM31/670	MS31/670
H 30/710	670	710	830	342	90	M 710x7	223,000	HM30/710	MS30/710
H 30/710 OH	670	710	830	342	90	M 710x7	228,000	HM30/710	MS30/710
H 39/710	670	710	830	286	90	M 710x7	196,000	HM30/710	MS30/710
H 39/710 OH	670	710	830	286	90	M 710x7	183,000	HM30/710	MS30/710
H 31/710	670	710	900	467	106	M 710x7	378,000	HM31/710	MS31/710
H 32/710	670	710	900	572	106	M 710x7	444,000	HM31/710	MS31/710
H 30/750	710	750	870	356	90	M 750x7	246,000	HM30/750	MS30/750
H 39/750	710	750	870	291	90	M 750x7	211,000	HM30/750	MS30/750
H 31/750	710	750	950	493	112	M 750x7	451,000	HM31/750	MS31/750
H 32/750	710	750	950	603	112	M 750x7	507,000	HM31/750	MS31/750
H 30/800	750	800	920	366	90	M 800x7	300,000	HM30/800	MS30/800
H 39/800	750	800	920	303	90	M 800x7	259,000	HM30/800	MS30/800
H 31/800	750	800	1000	505	112	M 800x7	515,000	HM31/800	MS31/800
H 32/800	750	800	1000	618	112	M 800x7	610,000	HM31/800	MS31/800
H 30/900 OH	850	900	1030	400	100	M 900x7	387	HM30/900	MS30/900-850

**Index other bore sizes**

- 470-850**
- 17-85**
- 90-180**
- 200-220**
- 240-320**
- 340-450**

**ACCESSORIES**

- Locking nut**
- Locking device**

**Details part number:**  
- Suffixes **OH**: sleeve including oil supply ducts and oil grooves.



Click here for  
Technical & Related  
Information

Deep Groove Ball Bearing	Self-Aligning Ball Bearing	Angular Contact Ball Bearing	
Cylindrical Roller Bearing	Tapered Roller Bearing	Spherical Roller Bearing	
Thrust Ball Bearing	Spherical Roller Thrust Bearing	<b>Accessories Adapter &amp; Withdrawal Sleeve</b>	Technical & Related Information

## 60200a

## Withdrawal Sleeve

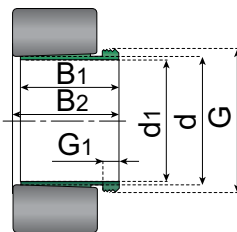

### Taper 1:12

Part number	Principal dimensions						Weight	Accessories included	
	d1	d	B1	B2	G	G1		Dismounting Nut	Locking Device
	mm						Kg	Part Number	Part Number
AH 308	35	40	29	32	M45x1,5	6	0,090	KM9	HMV9E
AH 2308	35	40	40	43	M45x1,5	7	0,130	KM9	HMV9E
AH 309	40	45	31	34	M50x1,5	6	0,110	KM10	HMV10E
AH 2309	40	45	44	47	M50x1,5	7	0,160	KM10	HMV10E
AH 310	45	50	35	38	M60x2	7	0,160	KM12	HMV12E
AH 2310	45	50	50	53	M60x2	8	0,240	KM12	HMV12E
AH 311	50	55	37	40	M65x2	7	0,190	KM13	HMV13E
AH 2311	50	55	54	57	M65x2	9	0,290	KM13	HMV13E
AH 312	55	60	40	43	M70x2	8	0,220	KM14	HMV14E
AH 2312	55	60	57	60	M70x2	10	0,340	KM14	HMV14E
AH 313	60	65	42	45	M75x2	8	0,250	KM15	HMV15E
AH 2313	60	65	61	64	M75x2	12	0,400	KM15	HMV15E
AH 314	65	70	43	47	M80x2	8	0,280	KM16	HMV16E
AH 2314	65	70	65	69	M85x2	10	0,530	KM17	HMV17E
AH 315	70	75	45	49	M85x2	8	0,310	KM17	HMV17E
AH 2315	70	75	69	53	M90x2	12	0,610	KM18	HMV18E
AH 316	75	80	48	52	M90x2	8	0,370	KM18	HMV18E
AH 2316	75	80	72	76	M95x2	12	0,670	KM19	HMV19E
AH 317	80	85	52	56	M100x2	9	0,480	KM20	HMV20E
AH 2317	80	85	75	79	M100x2	13	0,750	KM20	HMV20E
AH 318	85	90	53	57	M105x2	9	0,520	KM21	HMV21E
AH 2318	85	90	80	84	M105x2	14	0,850	KM21	HMV21E
AH 319	90	95	57	61	M110x2	10	0,590	KM22	HMV22E
AH 2319	90	95	85	89	M110x2	15	0,980	KM22	HMV22E
AH 320	95	100	59	63	M115x2	10	0,660	KM23	HMV23E
AH 2320	95	100	90	94	M120x2	15	1,230	KM24	HMV24E
AH 322	100	110	63	67	M130x2	12	1,260	KM26	HMV26E
AH 3122	100	110	68	72	M125x2	11	1,280	KM25	HMV25E
AH 2322	100	110	98	102	M130x2	16	2,110	KM26	HMV26E
AH 24122	105	110	82	91	M115x2	13	0,710	KM23	HMV23E
AH 3024	110	120	60	64	M130x2	13	1,150	KM26	HMV26E
AH 3124	110	120	75	79	M140x2	12	1,670	KM28	HMV28E
AH 2324	110	120	105	109	M140x2	17	2,470	KM28	HMV28E
AH 24024	115	120	73	82	M125x2	13	0,700	KM25	HMV25E
AH 24124	115	120	93	102	M130x2	13	1,000	KM26	HMV26E
AH 3026	120	130	67	71	M140x2	14	1,410	KM28	HMV28E
AH 3126	120	130	78	82	M150x2	12	1,870	KM30	HMV30E
AH 2326	120	130	115	119	M150x2	19	3,020	KM30	HMV30E
AH 24026	125	130	83	93	M135x2	14	0,880	KM27	HMV27E
AH 24126	125	130	94	104	M140x2	14	1,150	KM28	HMV28E
AH 3028	130	140	68	73	M150x2	14	1,550	KM30	HMV30E
AH 3128	130	140	83	88	M160x3	14	2,210	KM32	HMV32E
AH 2328	130	140	125	130	M160x3	20	3,600	KM32	HMV32E
AH 24028	135	140	83	93	M145x2	14	0,950	KM29	HMV29E
AH 24128	135	140	99	109	M150x2	14	1,300	KM30	HMV30E
AH 3030	140	150	72	5	M160x3	15	1,760	KM32	HMV32E
AH 3130	140	150	96	101	M170x3	15	2,700	KM34	HMV34E
AH 2330	140	150	135	140	M170x3	24	4,220	KM34	HMV34E
AH 24030	145	150	90	101	M155x3	15	1,050	KM31	HMV31E
AH 24130	145	150	115	126	M160x3	15	1,550	KM32	HMV32E

### Index other bore sizes



### ACCESSORIES



**Details part number:**  
- Suffixes **OH**: sleeve  
including oil supply  
ducts and oil grooves.



Deep Groove Ball Bearing	Self-Aligning Ball Bearing	Angular Contact Ball Bearing	
Cylindrical Roller Bearing	Tapered Roller Bearing	Spherical Roller Bearing	
Thrust Ball Bearing	Spherical Roller Thrust Bearing	<b>Accessories Adapter &amp; Withdrawal Sleeve</b>	Technical & Related Information

## 60200b

## Withdrawal Sleeve

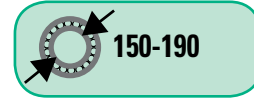
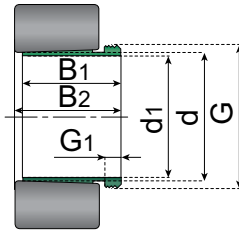

Click here for  
Technical & Related  
Information

### Taper 1:12

Part number	Principal dimensions						Weight	Accessories included	
	d1	d	B1	B2	G	G1		Dismounting Nut	Locking Device
	mm						Kg	Part Number	Part Number
AH 3032	150	160	77	82	M170x3	16	2,060	KM34	HMV34E
AH 24032	150	160	95	106	M170x3	15	2,300	KM34	HMV34E
AH 3132	150	160	103	108	M180x3	16	3,210	KM36	HMV36E
AH 24132	150	160	124	135	M170x3	15	3,000	KM34	HMV34E
AH 3232	150	160	124	130	M180x3	20	4,080	KM36	HMV36E
AH 2332	150	160	140	146	M180x3	24	4,720	KM36	HMV36E
AH 3034	160	170	85	90	M180x3	17	2,430	KM36	HMV36E
AH 3134	160	170	104	109	M190x3	16	3,400	KM38	HMV38E
AH 24034	160	170	106	117	M180x3	16	2,700	KM36	HMV36E
AH 24134	160	170	125	136	M180x3	16	3,250	KM36	HMV36E
AH 3234	160	170	134	140	M190x3	24	4,800	KM38	HMV38E
AH 2334	160	170	146	152	M190x3	24	5,250	KM38	HMV38E
AH 3136	160	180	116	122	M200x3	19	4,220	KM40	HMV40E
AH 3036	170	180	92	98	M190x3	17	2,810	KM38	HMV38E
AH 3036 OH	170	180	92	98	M190x3	17	2,800	KM38	HMV38E
AH 2236	170	180	105	110	M200x3	17	3,730	KM40	HMV40E
AH 24036	170	180	116	127	M190x3	16	3,200	KM38	HMV38E
AH 3136 OH	170	180	116	122	M200x3	19	3,900	KM38	HMV38E
AH 24136	170	180	134	145	M190x3	16	3,750	KM38	HMV38E
AH 3236	170	180	140	146	M200x3	24	5,320	KM40	HMV40E
AH 3236 OH	170	180	140	146	M200x3	24	4,850	KM38	HMV38E
AH 2336	170	180	154	160	M200x3	26	5,830	KM40	HMV40E
AH 2336 OH	170	180	154	160	M200x3	26	6,050	KM40	HMV40E
AH 3038	180	190	96	102	TR205x4	18	3,320	HML41T	HMV41E
AH 3038 OH	180	190	96	102	M205x3	18	3,300	KM40	HMV40E
AH 2238	180	190	112	117	TR210x4	18	4,250	HM42T	HMV42E
AH 24038	180	190	118	131	M200x3	18	3,550	KM40	HMV40E
AH 3138	180	190	125	131	TR210x4	20	4,890	HM42T	HMV42E
AH 3138 OH	180	190	125	131	TR210x4	20	4,500	KM40	HMV40E
AH 3238	180	190	145	152	TR210x4	25	5,900	KM42T	HMV42E
AH 3238 OH	180	190	145	152	TR210x4	25	5,900	KM40	HMV40E
AH 24138	180	190	146	159	M200x3	18	4,450	KM40	HMV40E
AH 2338	180	190	160	167	TR210x4	26	6,630	HM42T	HMV42E
AH 2338 OH	180	190	160	167	TR210x4	26	6,700	HM42T	HMV42E
AH 3940	190	200	77	83	TR210x4	16	2,620	KM40	HMV40E
AH 3040	190	200	102	108	TR215x4	19	3,800	HML43T	HMV43E
AH 3040 OH	190	200	102	108	TR215x4	19	3,700	HM42T	HMV42E
AH 2240	190	200	118	123	TR220x4	19	4,680	HM44T	HMV44E
AH 24040	190	200	127	140	TR210x4	18	4,000	HM42T	HMV42E
AH 3140	190	200	134	140	TR220x4	21	5,490	HM44T	HMV44E
AH 3140 OH	190	200	134	140	TR220x4	21	5,650	HM3044	HMV44E
AH 3240	190	200	153	160	TR220x4	25	6,680	HM44T	HMV44E
AH 3240 OH	190	200	153	160	TR220x4	25	6,600	HM3044	HMV44E
AH 24140 OH	190	200	158	171	TR210x4	18	5,050	HM42T	HMV42E
AH 2340	190	200	170	177	TR220x4	30	7,540	HM44T	HMV44E
AH 2340 OH	190	200	170	177	TR220x4	30	7,600	HM44T	HMV44E

### Index other bore sizes



### ACCESSORIES



**Details part number:**  
- Suffices **OH:** sleeve  
including oil supply  
ducts and oil grooves.



Deep Groove Ball Bearing	Self-Aligning Ball Bearing	Angular Contact Ball Bearing	
Cylindrical Roller Bearing	Tapered Roller Bearing	Spherical Roller Bearing	
Thrust Ball Bearing	Spherical Roller Thrust Bearing	<b>Accessories Adapter &amp; Withdrawal Sleeve</b>	Technical & Related Information



# 60200c

## Withdrawal Sleeve

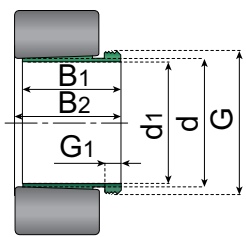

Click here for Technical & Related Information

Taper 1:12

Part number	Principal dimensions						Weight	Accessories included	
	d1	d	B1	B2	G	G1		Dismounting Nut	Locking Device
	mm						Kg	Part Number	Part Number
AH 3044	200	220	111	117	TR235x4	20	7,400	HML47T	HMV47E
AH 3044 OH	200	220	111	117	TR235X4	20	7,300	HM46T	HMV46E
AH 2244	200	220	130	136	TR240x4	20	9,100	HM48T	HMV48E
AH 3144	200	220	145	151	TR240x4	23	10,400	HM48T	HMV48E
AH 3144 OH	200	220	145	151	TR240x4	23	9,300	HM3048	HMV48E
AH 24144 OH	200	220	170	184	TR230x4	20	10,500	HM46T	HMV46E
AH 2344	200	220	181	189	TR240x4	30	13,500	HM48T	HMV48E
AH 2344 OH	200	220	181	189	TR240x4	30	13,500	HM48T	HMV48E
AH 3048	220	240	116	123	TR260x4	21	8,750	HM52T	HMV52E
AH 3048 OH	220	240	116	123	TR260x4	21	7,950	HM3052	HMV52E
AH 2248	220	240	144	150	TR260x4	21	11,100	HM52T	HMV52E
AH 2248 OH	220	240	144	150	TR260x4	21	11,500	HM3052	HMV52E
AH 3148	220	240	154	161	TR260x4	25	12,000	HM52T	HMV52E
AH 3148 OH	220	240	154	161	TR260x4	25	12,000	HM3052	HMV52E
AH 2348	220	240	189	197	TR260x4	30	15,500	HM52T	HMV52E
AH 2348 OH	220	240	189	197	TR260x4	30	14,000	HM52T	HMV52E

### Index other bore sizes



### ACCESSORIES



**Details part number:**  
- Suffixes **OH**: sleeve including oil supply ducts and oil grooves.



Deep Groove Ball Bearing	Self-Aligning Ball Bearing	Angular Contact Ball Bearing	
Cylindrical Roller Bearing	Tapered Roller Bearing	Spherical Roller Bearing	
Thrust Ball Bearing	Spherical Roller Thrust Bearing	<b>Accessories Adapter &amp; Withdrawal Sleeve</b>	Technical & Related Information



# 60200d

## Withdrawal Sleeve

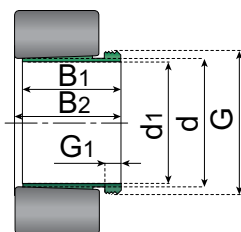

Click here for Technical & Related Information

### Taper 1:12

Part number	Principal dimensions						Weight	Accessories excluded	
	d1	d	B1	B2	G	G1		Dismounting Nut	Locking Device
	mm						Kg	Part Number	Part Number
AH 3052	240	260	128	135	TR280x4	23	10,700	HM56T	HMV56E
AH 3052 H	240	260	128	135	TR280x4	23	9,600	HM3056	HMV56E
AH 3052 OH	240	260	128	135	TR280x4	23	9,600	HM3056	HMV56E
AH 3952 G	240	260	155	100	TR280x4	18	7,700	HM58T	HMV58E
AH 2252	240	260	155	161	TR290x4	23	14,000	HM58T	HMV58E
AH 2252 OH	240	260	155	161	TR290x4	23	12,500	HM58T	HMV58E
AH 3152	240	260	172	179	TR290x4	26	16,200	HM58T	HMV58E
AH 3152 OH	240	260	172	179	TR290x4	26	15,500	HM3056	HMV56E
AH 2352	240	260	205	213	TR290x4	30	19,600	HM58T	HMV58E
AH 2352 OH	240	260	205	219	TR290x4	30	17,500	HM58T	HMV58E
AH 3056	260	280	131	139	TR300x4	24	12,000	HM3060	HMV60E
AH 3056 OH	260	280	131	139	TR300x4	24	11,000	HM3060	HMV60E
AH 2256	260	280	155	163	TR310x5	24	15,200	HM62T	HMV62E
AH 2256 OH	260	280	155	163	TR300x4	24	15,000	HM3160	HMV60E
AH 3156	260	280	175	183	TR310x5	28	17,500	HM62T	HMV62E
AH 3156 OH	260	280	175	183	TR310x5	28	17,000	HM3160	HMV60E
AH 24156 OH	260	280	202	219	TR300x4	22	16,3	HM60T	HMV60
AH 2356	260	280	212	220	TR310x5	30	17,100	HM3160	HMV60E
AH 2356 OH	260	280	212	220	TR310x5	30	19,500	HM62T	HMV62E
AH 3060	280	300	145	153	TR320x5	26	14,400	HM3064	HMV64E
AH 3060 OH	280	300	145	153	TR320x5	26	13,000	HM3064	HMV64E
AH 2260	280	300	170	178	TR330x5	26	18,100	HM66T	HMV66E
AH 2260 OH	280	300	170	178	TR330x5	26	18,000	HM3164	HMV64E
AH 3160	280	300	192	200	TR330x5	30	20,800	HM66T	HMV66E
AH 3160 OH	280	300	192	200	TR330x5	30	20,500	HM3164	HMV64E
AH 3260	280	300	228	236	TR330x5	34	26,000	HM66T	HMV66E
AH 3260 OH	280	300	228	236	TR330x5	34	23,500	HM3164	HMV64E
AH 3064	300	320	149	157	TR345x5	27	17,000	HM3068	HMV68E
AH 3064 OH	300	320	149	157	TR345x5	27	17,000	HM3068	HMV68E
AH 2264	300	320	180	190	TR350x5	27	20,200	HM70T	HMV70E
AH 2264 OH	300	320	180	190	TR350x5	27	20,000	HM3168	HMV68E
AH 3164	300	320	209	217	TR350x5	31	24,500	HM70T	HMV70E
AH 3164 OH	300	320	209	217	TR350x5	31	24,500	HM3168	HMV68E
AH 3264	300	320	246	254	TR350x5	36	30,600	HM70T	HMV70E
AH 3264 OH	300	320	246	254	TR350x5	36	27,500	HM3168	HMV68E
AH 3068	320	340	162	171	TR365x5	28	19,000	HM3072	HMV72E
AH 3068 OH	320	340	162	171	TR365x5	28	19,000	HM3072	HMV72E
AH 3168	320	340	225	234	TR370x5	33	29,000	HM74T	HMV74E
AH 3168 OH	320	340	225	234	TR370x5	33	28,500	HM3172	HMV72E
AH 3268	320	340	264	273	TR370x5	38	35,400	HM74T	HMV74E
AH 3268 OH	320	340	264	273	TR370x5	38	32,000	HM3172	HMV72E
AH 24168 OH	320	340	269	288	TR360x5	26	27,100	HM72T	HMV72

### Index other bore sizes

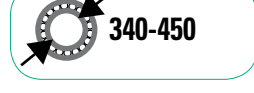

### ACCESSORIES



**Details part number:**  
- Suffixes **OH**: sleeve including oil supply ducts and oil grooves.





Deep Groove Ball Bearing	Self-Aligning Ball Bearing	Angular Contact Ball Bearing	
Cylindrical Roller Bearing	Tapered Roller Bearing	Spherical Roller Bearing	
Thrust Ball Bearing	Spherical Roller Thrust Bearing	<b>Accessories Adapter &amp; Withdrawal Sleeve</b>	Technical & Related Information



# 60200e

## Withdrawal Sleeve

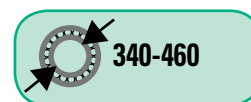
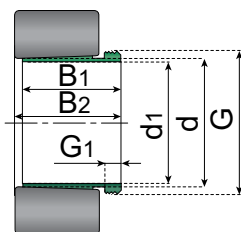

Click here for Technical & Related Information

### Taper 1:12

Part number	Principal dimensions						Weight	Accessories excluded	
	d1	d	B1	B2	G	G1		Dismounting Nut	Locking Device
	mm						Kg	Part Number	Part Number
AH 3072	340	360	167	176	TR385X5	30	21,000	HM3076	HMV76E
AH 3072 OH	340	360	167	176	TR385X5	30	21,000	HM3076	HMV76E
AH 3172	340	360	229	238	TR400X5	33	30,500	HM3180	HMV80E
AH 3172 OH	340	360	229	238	TR400X5	35	30,500	HM3176	HMV76E
AH 24172 OH	340	360	269	289	TR380X5	26	30,800	HM3176	HMV76E
AH 3272	340	360	274	283	TR400X5	40	41,500	HM3180	HMV80E
AH 3272 OH	340	360	274	283	TR380X5	40	35,500	HM3176	HMV76E
AH 3076	360	380	170	180	TR410X5	31	22,500	HM3080	HMV80E
AH 3076 OH	360	380	170	180	TR410X5	31	22,500	HM3080	HMV80E
AH 3176	360	380	232	242	TR420X5	36	35,700	HM3184	HMV84E
AH 3176 OH	360	380	232	242	TR420X5	36	33,000	HM3180	HMV80E
AH 3276	360	380	284	294	TR420X5	42	45,600	HM3184	HMV84E
AH 3276 OH	360	380	284	294	TR420X5	42	42,000	HM3180	HMV80E
AH 3080	380	400	183	193	TR430X5	33	26,000	HM3080	HMV84E
AH 3080 OH	380	400	183	193	TR430X5	33	26,000	HM3080	HMV84E
AH 3180	380	400	240	250	TR440X5	38	39,500	HM3188	HMV88E
AH 3180 OH	380	400	240	250	TR440X5	38	36,000	HM3184	HMV84E
AH 3280	380	400	302	312	TR440X5	44	51,700	HM3188	HMV88E
AH 3280 OH	380	400	302	312	TR440X5	44	48,000	HM3184	HMV84E
AH 3084	400	420	186	196	TR450X5	34	28,000	HM3088	HMV88E
AH 3084 OH	400	420	186	196	TR450X5	34	28,000	HM3088	HMV88E
AH 3184	400	420	266	276	TR460X5	40	27,900	HM3088	HMV88E
AH 3184 OH	400	420	266	276	TR460X5	40	43,000	HM3188	HMV88E
AH 3284	400	420	321	331	TR460X5	46	46,500	HM3192	HMV92E
AH 3284 OH	400	420	321	331	TR440X5	46	54,500	HM3188	HMV88E
AH 3088	420	440	194	205	TR470X5	35	31,000	HM3092	HMV92E
AH 3088 OH	420	440	194	205	TR470X5	35	31,000	HM3092	HMV92E
AH 3188	420	440	270	281	TR480X5	42	49,800	HM3196	HMV96E
AH 3188 OH	420	440	270	281	TR480X5	42	46,000	HM3192	HMV92E
AH 3288	420	440	330	341	TR460X5	48	64,500	HM3192	HMV92E
AH 3288 OH	420	440	330	341	TR460X5	48	64,500	HM3192	HMV92E
AH 3092	440	460	202	213	TR490X5	37	34,000	HM3096	HMV96E
AH 3092 OH	440	460	202	213	TR490X5	37	34,000	HM3096	HMV96E
AH 3192	440	460	285	296	TR510X6	43	51,500	HM3196	HMV96E
AH 3192 OH	440	460	285	296	TR510X6	43	51,500	HM3196	HMV96E
AH 3292	440	460	349	360	TR480X5	50	80,000	HM3196	HMV96E
AH 3292 OH	440	460	349	360	TR480X5	50	80,000	HM3196	HMV96E
AH 3996 OH	460	480	158	157	TR500X5	28	25,800	HM31/500	HMV100E
AH 3096	460	480	205	217	TR520X6	38	34,000	HM30/500	HMV100E
AH 3096 OH	460	480	205	217	TR520X6	38	34,000	HM30/500	HMV100E
AH 3196	460	480	295	307	TR530X6	45	63,000	HM31/500	HMV100E
AH 3196 OH	460	480	295	307	TR530X6	45	63,000	HM31/500	HMV100E
AH 3296	460	480	364	376	TR500X5	52	81,000	HM31/500	HMV100E
AH 3296 OH	460	480	364	376	TR500X5	52	81,000	HM31/500	HMV100E

### Index other bore sizes

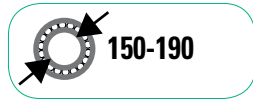

### ACCESSORIES



**Details part number:**  
 - Suffixes **OH**: sleeve including oil supply ducts and oil grooves.



Deep Groove Ball Bearing	Self-Aligning Ball Bearing	Angular Contact Ball Bearing	
Cylindrical Roller Bearing	Tapered Roller Bearing	Spherical Roller Bearing	
Thrust Ball Bearing	Spherical Roller Thrust Bearing	<b>Accessories Adapter &amp; Withdrawal Sleeve</b>	Technical & Related Information



# 60200f

## Withdrawal Sleeve

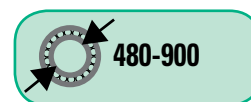
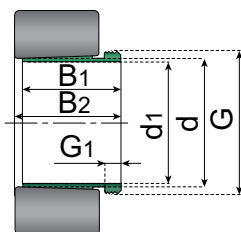

Click here for Technical & Related Information

### Taper 1:12

Part number	Principal dimensions						Weight	Accessories excluded	
	d1	d	B1	B2	G	G1		Dismounting Nut	Locking Device
	mm						Kg	Part Number	Part Number
AH 30/500	480	500	209	221	TR530X6	40	41,000	HM30/530	HMV106E
AH 30/500 OH	480	500	209	221	TR530X6	40	41,000	HM30/530	HMV106E
AH 31/500	480	500	313	325	TR530X6	47	66,500	HM31/530	HMV106E
AH 31/500 OH	480	500	313	325	TR530X6	47	66,500	HM31/530	HMV106E
AH 30/530	500	530	230	242	TR560X6	45	61,900	HM30/560	HMV112E
AH 30/530 OH	500	530	230	242	TR560X6	45	63,500	HM30/560	HMV112E
AH 31/530	500	530	325	337	TR560x6	53	93,400	HM31/560	
AH 32/530	500	530	412	424	TR580x6	57	133,000	HM116T	HMV16E
AH 30/560	530	560	240	252	TR600X6	45	73,500	HM30/600	HMV120E
AH 30/560 OH	530	560	240	252	TR600X6	45	73,500	HM30/600	HMV120E
AH 31/560	530	560	335	347	TR600x6	55	108,000	HM31/600	
AH 30/600	560	600	245	259	TR630X6	45	77,000	HM30/630	HMV126E
AH 30/600 OH	560	600	245	259	TR630X6	45	77,000	HM30/630	HMV126E
AH 30/630	600	630	258	272	TR670X6	46	89,700	HM30/670	HMV134E
AH 30/630 OH	600	630	258	272	TR670X6	46	88,500	HM30/670	HMV134E
AH 31/630	600	630	375	389	TR670x6	60	140,000	HM31/670	
AH 32/630	600	630	475	489	TR680x6	63	191,000	HM136T	HMV36E
AH 30/670 OH	630	370	280	294	TR710X7	50	125,000	HM30/710	HMV142E
AH 30/670	630	670	280	294	TR710X7	50	127,000	HM30/710	HMV142E
AH 32/670	630	670	500	514	TR720x7	62	256,000	HM144T	HMV44E
AH 30/710	670	710	286	302	TR750X7	50	138,000	HM30/750	HMV150E
AH 30/710 OH	670	710	286	302	TR750X7	50	138,000	HM30/750	HMV150E
AH 32/710	670	710	500	516	TR760x7	65	282,000	HM31/750	
AH 30/750	710	750	300	316	TR800x7	50	159,000	HM30/800	
AH 31/750	710	750	425	441	TR800x7	60	238,000	HM31/800	
AH 32/750	710	750	540	556	TR800x7	65	320,000	HM31/800	
AH 30/800	750	800	308	326	TR850x7	50	204,000	HM30/850	
AH 31/800	750	800	438	456	TR850x7	63	305,000	HM31/850	
AH 32/800	750	800	550	568	TR850x7	67	401,000	HM31/850	
AH 30/850	800	850	325	343	TR900x7	53	230,000	HM30/900	
AH 31/850	800	850	462	480	TR900x7	62	345,000	HM31/900	
AH 32/850	800	850	585	603	TR900x7	70	461,000	HM31/900	
AH 30/900	850	900	335	355	TR950x8	55	253,000	HM30/950	
AH 31/900	850	900	475	495	TR950x8	63	379,000	HM31/950	
AH 32/900	850	900	585	605	TR950x8	70	489,000	HM31/950	
AH 32/900	850	900	585	605	TR950x8	70	489,000	HM31/950	
AH 30/950	900	950	355	375	TR1000x8	55	285,000	HM30/1000	
AH 31/950	900	950	500	520	TR1000x8	62	426,000	HM31/1000	
AH 32/950	900	950	600	620	TR1000x8	70	533,000	HM31/1000	

### Index other bore sizes

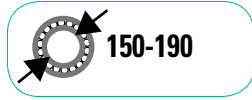
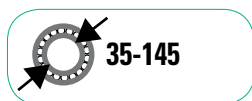

### ACCESSORIES



**Details part number:**  
 - Suffixes **OH**: sleeve including oil supply ducts and oil grooves.



Deep Groove Ball Bearing	Self-Aligning Ball Bearing	Angular Contact Ball Bearing	
Cylindrical Roller Bearing	Tapered Roller Bearing	Spherical Roller Bearing	
Thrust Ball Bearing	Spherical Roller Thrust Bearing	<b>Accessories Adapter &amp; Withdrawal Sleeve</b>	Technical & Related Information



# 60250a

## Accessories

### Locking device for adapter sleeves



Click here for Technical & Related Information

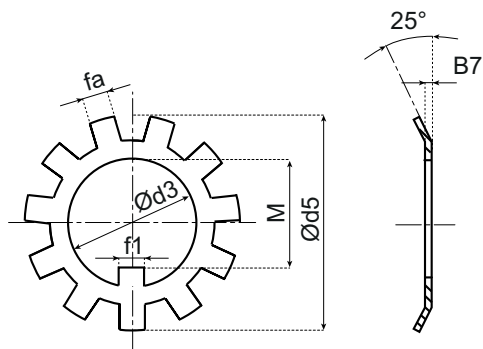

Locking device	Principal dimensions			Inner lip		outer lip		weight	Suitable for use with locking device type (not included)
	bore	outer	thickness	width	depth	width	number	Kg	
Part number	d3	d5	B7	f1	M	fa	lips	m	
MB 0	10	21	1	3	8,5	3	9	0,001	KM 0
MB 1	12	25	1	3	10,5	3		0,002	KM 1
MB 2	15	28	1	4	13,5	4	11	0,003	KM 2
MB 3	17	32	1	4	15,5	4		0,003	KM 3
MB 4	20	36	1	4	18,5	4		0,004	KM 4
MB 5	25	42	1,25	5	23	5		0,006	KM 5
MB 6	30	49	1,25	5	27,5	5		0,008	KM 6
MB 7	35	57	1,25	6	32,5	5	13	0,011	KM 7
MB 8	40	62	1,25	6	37,5	6		0,013	KM 8
MB 9	45	69	1,25	6	42,5	6		0,015	KM 9
MB 10	50	74	1,25	6	47,5	6		0,016	KM 10
MB 11	55	81	1,5	8	52,5	7		0,022	KM 11
MB 12	60	86	1,5	8	57,5	7		0,024	KM 12
MB 13	65	92	1,5	8	62,5	7		0,03	KM 13
MB 14	70	98	1,5	8	66,5	8		0,032	KM 14
MB 15	75	104	1,5	8	71,5	8		0,035	KM 15
MB 16	80	112	1,8	10	76,5	8		0,046	KM 16
MB 17	85	119	1,8	10	81,5	8		0,053	KM 17
MB 18	90	126	1,8	10	86,5	10		0,061	KM 18
MB 19	95	133	1,8	10	91,5	10		0,066	KM 19
MB 20	100	142	1,8	12	96,5	10		0,077	KM 20
MB 21	105	145	1,8	12	100,5	12		0,083	KM 21
MB 22	110	154	1,8	12	105,5	12	17	0,091	KM 22
MB 23	115	159	2	12	110,5	12		0,11	KM 23
MBL 24	120	-	2	14	115	12		0,07	KML 24
MB 24	120	164	2	14	115	12		0,11	KM 24
MB 25	125	170	2	14	120	12		0,12	KM 25
MBL 26	130	161	2	14	125	12		0,08	KML 26
MB 26	130	175	2	14	125	12		0,12	KM 26
MB 27	135	185	2	14	130	14		0,14	KM 27
MBL 28	140	171	2	16	135	12		0,09	KML 28
MB 28	140	192	2	16	135	14		0,14	KM 28
MB 29	145	202	2	16	140	14		0,17	KM 29
MBL 30	150	-	2	16	145	14		0,1	KML 30
MB 30	150	205	2	16	145	14		0,18	KM 30
MB 31	155	212	2,5	16	147,5	16		0,2	KM 31
MBL 32	160	199	2,5	18	154	14		0,14	KML 32
MB 32	160	217	2,5	18	154	16		0,22	KM 32
MB 33	165	222	2,5	18	157,5	16		0,24	KM 33
MBL 34	170	211	2,5	18	164	16		0,15	KML 34
MB 34	170	232	2,5	18	164	16		0,24	KM 34
MBL 36	180	221	2,5	20	174	16		0,16	KML 36
MB 36	180	242	2,5	20	174	18		0,26	KM 36
MBL 38	190	231	2,5	20	184	16		0,17	KML 38
MB 38	190	252	2,5	20	184	18	19	0,26	KM 38
MBL 40	200	-	2,5	20	194	18		0,22	KML 40
MB 40	200	262	2,5	20	194	18		0,28	KM 40
MB 44	220	292	3	24	213	20		0,35	HM 44
MB 48	240	312	3	24	233	20		0,45	HM 48
MB 52	260	342	3	28	253	24		0,65	HM 52
MB 56	280	362	3	28	273	24		0,74	HM 56

**Adapter sleeves**

**Withdrawal sleeves**

**Locking nut**



Deep Groove Ball Bearing	Self-Aligning Ball Bearing	Angular Contact Ball Bearing	
Cylindrical Roller Bearing	Tapered Roller Bearing	Spherical Roller Bearing	
Thrust Ball Bearing	Spherical Roller Thrust Bearing	<b>Accessories Adapter &amp; Withdrawal Sleeve</b>	Technical & Related Information

# 60250b

## Accessories

### Locking nut for adapter & withdrawal sleeves



Click here for Technical & Related Information

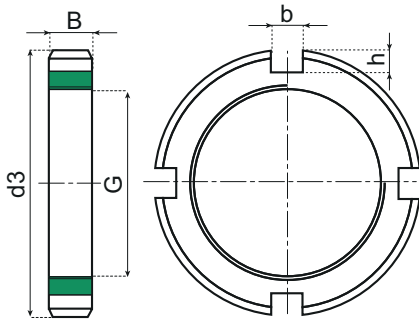

NUT	Principal dimensions				lock		weight	Suitable for use with locking device type (not included)
	bore	outer	width	thread	width	depth		
	mm						Kg	
Part number	d	d3	B	G	b	h	-	
KM 0	10	18	4	M 10x0.75	4	3	0,004	MB 0
KM 1	12	22	4	M 12x1	4	3	0,006	MB 1
KM 2	15	25	5	M 15x1	5	4	0,009	MB 2
KM 3	17	28	5	M 17x1	5	4	0,015	MB 3
KM 4	20	32	6	M 20x1	6	4	0,025	MB 4
KM 5	25	38	7	M 25x1.5	7	5	0,028	MB 5
KM 6	30	45	7	M 30x1.5	7	5	0,039	MB 6
KM 7	35	52	8	M 35x1.5	8	5	0,059	MB 7
KM 8	40	58	9	M 40x1.5	9	6	0,078	MB 8
KM 9	45	65	10	M 45x1.5	10	6	0,11	MB 9
KM 10	50	70	11	M 50x1.5	11	6	0,14	MB 10
KM 11	55	75	11	M 55x2	11	7	0,15	MB 11
KM 12	60	80	11	M 60x2	11	7	0,16	MB 12
KM 13	65	85	12	M 65x2	12	7	0,19	MB 13
KM 14	70	92	12	M 70x2	12	8	0,23	MB 14
KM 15	75	98	13	M 75x2	13	8	0,27	MB 15
KM 16	80	105	15	M 80x2	15	8	0,36	MB 16
KM 17	85	110	16	M 85x2	16	8	0,41	MB 17
KM 18	90	120	16	M 90x2	16	10	0,51	MB 18
KM 19	95	125	17	M 95x2	17	10	0,55	MB 19
KM 20	100	130	18	M 100x2	18	10	0,64	MB 20
KM 21	105	140	18	M 105x2	18	12	0,79	MB 21
KM 22	110	145	19	M 110x2	19	12	0,87	MB 22
KM 23	115	150	19	M 115x2	19	12	0,91	MB 23
KML 24	120	145	20	M 120x2	20	12	0,69	MBL 24
KM 24	120	155	20	M 120x2	20	12	0,97	MB 24
KM 25	125	160	21	M 125x2	21	12	1,09	MB 25
KML 26	130	155	21	M 130x2	21	12	0,8	MBL 26
KM 26	130	165	21	M 130x2	21	12	1,09	MB 26
KM 27	135	175	22	M 135x2	22	14	1,39	MB 27
KML 28	140	165	22	M 140x2	22	12	0,92	MBL 28
KM 28	140	180	22	M 140x2	22	14	1,4	MB 28
KM 29	145	190	24	M 145x2	24	14	1,8	MB 29
KML 30	150	180	24	M 150x2	24	14	1,25	MBL 30
KM 30	150	195	24	M 150x2	24	14	1,88	MB 30
KM 31	155	200	25	M 155x3	25	16	2,09	MB 31
KML 32	160	190	25	M 160x3	25	14	1,39	MBL 32
KM 32	160	210	25	M 160x3	25	16	2,29	MB 32
KM 33	165	210	26	M 165x3	26	16	2,31	MB 33
KML 34	170	200	26	M 170x3	26	16	1,56	MBL 34
KM 34	170	220	26	M 170x3	26	16	2,54	MB 34
KML 36	180	210	27	M 180x3	27	16	1,78	MBL 36
KM 36	180	230	27	M 180x3	27	18	2,78	MB 36
KML 38	190	220	28	M 190x3	28	16	1,84	MBL 38
KM 38	190	240	28	M 190x3	28	18	3,05	MB 38
KML 40	200	240	29	M 200x3	29	18	2,61	MBL 40
KM 40	200	250	29	M 200x3	29	18	3,37	MB 40
KM 42	210	270	30	M 210x4	20	10		MB 42
KM 44	220	280	32	M 220x4	20	10		MB 44
KM 46	230	290	34	M 230x4	20	10		MB 46
KM 48	240	300	34	M 240x4	20	10		MB 48
KM 50	250	320	36	M 250x4	20	10		MB 50
KM 52	260	330	36	M 260x4	24	12		MB 52
KM 56	280	350	38	M 280x4	24	12		MB 56

**Adapter sleeves**

**Withdrawal sleeves**

**Locking nut**



Deep Groove Ball Bearing	Self-Aligning Ball Bearing	Angular Contact Ball Bearing	
Cylindrical Roller Bearing	Tapered Roller Bearing	Spherical Roller Bearing	
Thrust Ball Bearing	Spherical Roller Thrust Bearing	Accessories Adapter & Withdrawal Sleeve	Technical & Related Information



# 90000a

## Related information index

### Related & technical information section

#### BEARING CHARACTERISTICS AND THEIR TYPICAL APPLICATIONS

Deep groove ball bearings .....	<b>90010a</b>
Angular contact ball bearings .....	<b>90010b</b>
Double row self aligning ball bearings .....	<b>90010c</b>
Cylindrical roller bearings .....	<b>90010d</b>
Tapered roller bearings.....	<b>90010e</b>
Spherical roller bearings .....	<b>90010f</b>
Thrust ball bearings .....	<b>90010h</b>

#### BEARING SELECTION

Selection criteria .....	<b>90020a</b>
Bearing size .....	<b>90030a</b>
Safety factor & life rating .....	<b>90030c</b>
Life equation .....	<b>90030e</b>
Life table .....	<b>90030h</b>
Nomogram nominal life .....	<b>90030k</b>
Nominal life calculation .....	<b>90030m</b>
Life factors fV and fL .....	<b>90030n</b>
Adjusted rating life .....	<b>90030r</b>
Life adjustment factors .....	<b>90030s</b>
Service Life .....	<b>90030t</b>

#### DYNAMIC & STATIC LOAD CALCULATIONS

Deep groove ball bearings .....	<b>90031a</b>
Double row self aligning ball bearings .....	<b>90032a</b>
Single row angular contact ball bearings .....	<b>90033a</b>
Cylindrical roller bearings .....	<b>90034a</b>
Tapered roller bearings .....	<b>90035a</b>
Spherical roller bearings .....	<b>90036a</b>
Thrust ball bearings .....	<b>90037a</b>
Spherical roller thrust bearings .....	<b>90038a</b>

#### GENERAL INFORMATION

Limited Speed .....	<b>90040a</b>
Materials .....	<b>90050a</b>
Suffixes and prefixes legenda .....	<b>90060a</b>
Lubrication .....	<b>90070a</b>
Handling, storage, dismantling and replacement .....	<b>90080a</b>

#### FITS AND CLEARANCES

Introduction .....	<b>90090a</b>
Deep groove ball bearings .....	<b>90090c</b>
Angular contact ball bearings .....	<b>90090e</b>
Double row self aligning ball bearings .....	<b>90090h</b>
Cylindrical roller bearings .....	<b>90090m</b>
Spherical roller bearings .....	<b>90090r</b>
Tapered roller bearings .....	<b>90090t</b>

#### TOLERANCES

Shaft tolerances for cylindrical bore bearings .....	<b>90100a</b>
Shaft tolerances for thrust bearings .....	<b>90100a</b>
Shaft tolerances for adapter sleeves and withdrawal sleeves .....	<b>90100c</b>
Housing tolerances for radial bearings .....	<b>90100c</b>
Housing tolerances for thrust bearings .....	<b>90100c</b>
Shaft and Housing machining tolerances.....	<b>90100h</b>
ISO Standard.....	<b>90100r</b>

#### PRECISION CLASS

Introduction and legenda symbols .....	<b>90355a</b>
Radial bearings, metric size, class P0 .....	<b>90355c</b>
Radial bearings, metric size, class P6-P5-P4 .....	<b>90355e</b>
Tapered roller bearings, metric size, class P0 .....	<b>90355f</b>
Tapered roller bearings, metric size, class P4-P5 .....	<b>90355h</b>
Tapered roller bearings, inch size, AFBMA standard .....	<b>90355k</b>
Thrust bearings, metric size, class P5-P6 .....	<b>90355m</b>

#### ABUTMENTS

Introduction & guidelines .....	<b>90370a</b>
Deep groove ball bearings, series .....	<b>90372a</b>
Deep groove ball bearings, series .....	<b>90372c</b>
Self aligning ball bearings, series .....	<b>90374d</b>
Single row cylindrical roller bearings .....	<b>30374f</b>
Single row angular contact bearings .....	<b>30374h</b>

#### SNAP RING

Groove dimensions .....	<b>90400a</b>
Snap ring dimensions .....	<b>90401a</b>

Contact us

To contact your local Technical Support check our website: [www.RegalBeloit.com/Rollway](http://www.RegalBeloit.com/Rollway) or send an email to [info-belgium@regalbeloit.com](mailto:info-belgium@regalbeloit.com)  
 We cannot take responsibility for imperfections, damage or injuries due to wrong conveyor design, poor installation or improper use of our products made with or without reference to the information in this manual. We appreciate your suggestions to improve this Related information.



Deep Groove Ball Bearing	Self-Aligning Ball Bearing	Angular Contact Ball Bearing	
Cylindrical Roller Bearing	Tapered Roller Bearing	Spherical Roller Bearing	
Thrust Ball Bearing	Spherical Roller Thrust Bearing	Accessories Adapter & Withdrawal Sleeve	Technical & Related Information



# 9 0 0 1 0 a

## Bearing characteristics - types and application

### Deep groove Ball Bearing

Deep groove ball bearings are non-separable, comparatively rigid radial bearings, their balls are guided in deep radial running grooves. They are characterized by a high radial and axial load carrying capacity and can operate at very high speed. Combined loads are accommodated to an optimum degree - in fact, at higher speeds they are often better suited to transmit thrust loads than the ball thrust bearing. For these reasons and their economical price, it is the most widely used bearing. Deep groove ball bearings are also available with one or two non-rubbing metal shields (Z, ZZ) or rubbing seals (RS, 2RS) made from synthetic rubber. Bearings with two shields or two seals are pre-lubricated with the correct quantity of grease of a lithium base which permits operating temperatures of  $-30^{\circ}\text{C} + 120^{\circ}\text{C}$  ( $-22^{\circ}\text{F} + 248^{\circ}\text{F}$ ). Deep groove ball bearings with snap ring groove (N) and snap ring (R) in the outer ring enables a simple and space-saving axial location in the housing.



### Angular Misalignment

The following is an approximate guide to the misalignment that can be accommodated in the use of a single row ball bearing:

0.0010 radians

A greater degree of misalignment can sometimes be accommodated if pure radial load is applied, particularly if the misalignment results from occasional peak load, and if the bearing had sufficient radial internal clearance after mounting to avoid excessive stresses.

Open	ZZ 2 shields	2RS 2 seals	M			
				Brass cage Steel cage		
Special versions						
Z 1 shield	RS 1 seal	N circular groove for snap ring	ZZN 2 shields, circular groove for snap ring	ZNR 1 shield circular groove with snap ring	ZZNR 2 shields circular groove	ZN 1 shield circular groove for snap ring



Deep Groove Ball Bearing	Self-Aligning Ball Bearing	Angular Contact Ball Bearing	
Cylindrical Roller Bearing	Tapered Roller Bearing	Spherical Roller Bearing	
Thrust Ball Bearing	Spherical Roller Thrust Bearing	Accessories Adapter & Withdrawal Sleeve	Technical & Related Information



# 9 0 0 1 0 b

## Bearing characteristics - types and application

### Angular Contact Ball Bearing

There are single-row and double-row angular contact bearings and also duplex ( four point contact bearing). Single-row angular contact ball bearings are non-separable and the standard types feature a contact angle of 40°. They are suitable for the accommodation of combined (radial and axial) loads. Axial loads may be transmitted in the direction of the closed faced or high shoulder only.

Optimum load transmission starts with  $F_a \geq F_r$ . Radial forces induce internal axial forces which are absorbed by the opposed bearing. Such bearings should therefore be mounted in pairs, and should be adjusted against another bearing. In the case of length variations of the shaft caused by changes in temperature, which also affects the internal clearance, the distance between the bearings should be kept small.

The maximum permissible speed is somewhat lower than that of deep groove ball bearings. A slight angular deflection is still possible with the single bearing; if bearings are mounted in pairs, however, rigidity greatly increases together with the ability to prevent misalignment.

Single-row angular contact bearings can also be supplied with side faces ground for mounting side-by-side, Suffixes DF, DB, and DT are being used in the bearing designation, ie 7250 BG. They can be mounted in any of three combinations depending on the loading characteristics:

- A back-to-back arrangement (closed face together, load line of the bearings diverging towards the shaft axis) is used where rigidity and an ability to absorb fitting moment is required.
- A face-to-face arrangement (open faces together, load line of the bearings converging on shaft axis) is used where axial loads acting in both directions are to be catered for by one bearing in one direction.

Rigidity is better in the back-to-back arrangement. In the face-to-face arrangement, there is less ability to absorb fitting moments.

- A tandem arrangement (open face-to-closed-face load lines being parallel to each other) is used for thrust loads equally distributed over all bearings, absorbed in one direction only. Adjustment against another bearing which accommodates the opposed thrust load is necessary.

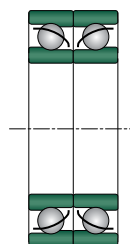

Back to Back DB

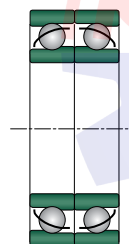

Face to Face DFT

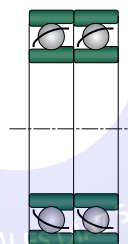

Tandem DT

### Double Row Angular Contact Bearings

The inner and outer ring of these bearings each have a double raceway, and the two rows of balls have contact angles that are similar to a back-to-back arrangement. Thrust loads can be accommodated in either directions as well as fitting moments.

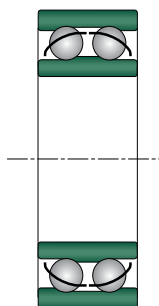

Face to Face DF

### Four Point (Duplex)

The 'four-point' contact bearings, or duplex bearings, are in principle angular contact bearings that accommodate axial loading in both directions. They usually have more axial movement than a pair of angular contact bearings correctly adjusted endwise; they are also able to carry combined radial and axial loading, providing the axial load exceeds the radial load at all times. Duplex bearings should not run unloaded, particularly at high speeds, for in this condition the balls contact the raceways at three or four points instead of two points necessary to correct running. Three or four point contact results in over-heating due to the balls skidding. When duplex bearings are required to carry axial loads only, then the outer rings must have radial clearance in the housing.

### Angular Misalignment

The following is an approximate guide to the misalignment that can be prevalent when fitting angular contact bearings: 0.0003 radians. Greater misalignment, particularly under pure axial load, can become critical.



Deep Groove Ball Bearing	Self-Aligning Ball Bearing	Angular Contact Ball Bearing	
Cylindrical Roller Bearing	Tapered Roller Bearing	Spherical Roller Bearing	
Thrust Ball Bearing	Spherical Roller Thrust Bearing	Accessories Adapter & Withdrawal Sleeve	Technical & Related Information

# 9 0 0 1 0 c

## Bearing characteristics - types and application

### Self Aligning Ball Bearing



This design of bearing utilizes two rows of balls, with the inner ring having two deep groove raceways and the outer ring a single continuous spherical raceway. This permits the inner and outer ring to be misaligned relative to each other through a comparatively large angle without imposing moment loads upon the balls. This bearing is frequently used when the inner ring is to be mounted upon an adapter sleeve or when conditions in the machine make it difficult to assure accurate alignment of the inner and outer rings.

Due to the small contact angle, the thrust capacity of these bearings is limited.

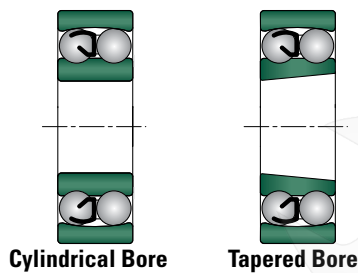

Cylindrical Bore

Tapered Bore

### Angular Misalignment

The following is an approximate guide to the misalignment that can be accommodated in a double row self aligning ball bearing: 0.04 radians between 2.5 and 3 degrees depending on which series is used.

Bearing series	Permissible Angular Misalignment Degrees
1200 – 1222	2.5
1302 – 1318	3
2200 – 2222	2.5
2300 – 2318	3





Deep Groove Ball Bearing	Self-Aligning Ball Bearing	Angular Contact Ball Bearing	
Cylindrical Roller Bearing	Tapered Roller Bearing	Spherical Roller Bearing	
Thrust Ball Bearing	Spherical Roller Thrust Bearing	Accessories Adapter & Withdrawal Sleeve	Technical & Related Information



# 9 | 0 | 0 | 1 | 0 | d

## Bearing characteristics - types and application

### Cylindrical Roller Bearing

The rollers of these bearings are essentially cylindrical in shape, providing modified line contact with the cylindrical inner and outer ring raceways. The rollers are accurately guided by ground ribs on either the inner ring or the outer ring, thus making these bearings suitable for heavy radial loads and high speed operation. For best results, these bearings should be accurately aligned. The cylindrical shape of the rollers allows the inner ring to have considerable axial movement relative to the outer ring. This feature is valuable in accommodating thermal expansion in applications where both the inner ring and outer ring must be press-fitted. Also, since the inner and outer rings are separable from each other, the assembly of equipment is frequently facilitated.



#### Single Row Cylindrical Roller Bearing

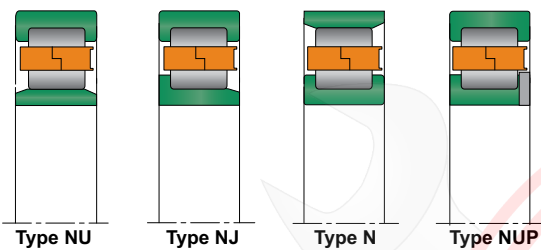

#### Double Row Cylindrical Roller Bearing

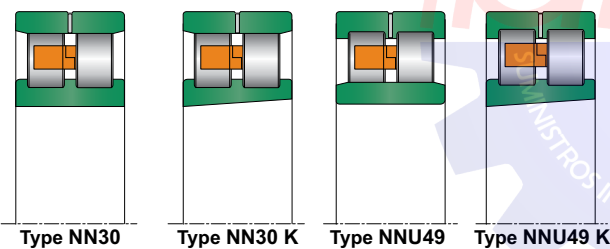

#### Single Row Full Cylindrical Roller Bearing

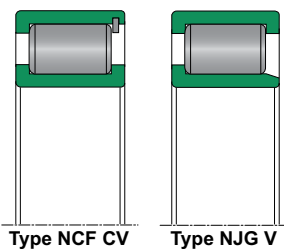

#### Double Row Full Cylindrical Roller Bearing

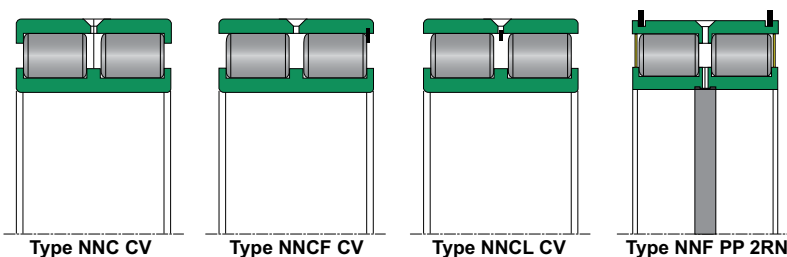

#### Angular Misalignment

the following is an approximate guide to the misalignment that can be accommodated in a cylindrical roller bearing:  
0.0004 radians

Greater misalignment under heavy radial load can be critical.



Deep Groove Ball Bearing	Self-Aligning Ball Bearing	Angular Contact Ball Bearing	
Cylindrical Roller Bearing	Tapered Roller Bearing	Spherical Roller Bearing	
Thrust Ball Bearing	Spherical Roller Thrust Bearing	Accessories Adapter & Withdrawal Sleeve	Technical & Related Information



# 9 | 0 | 0 | 1 | 0 | e

## Bearing characteristics - types and application

### Tapered Roller Bearing

This design utilizes conical rollers and raceways arranged so that all elements of the roller and raceway cones meet at a common apex on the axis of rotation. The rollers are guided by contact between the large end of the roller and a rib on the high capacity for radial loads and single direction thrust loads.

The bearings are usually mounted in pairs with axial adjustment to provide proper running clearance within the bearings. Being separable, inner and outer rings may be mounted individually. For heavy thrust loads, the type 30300 with large contact angle is desirable. Tapered roller bearings with two and four rows of rollers are used for special applications.



#### Matched

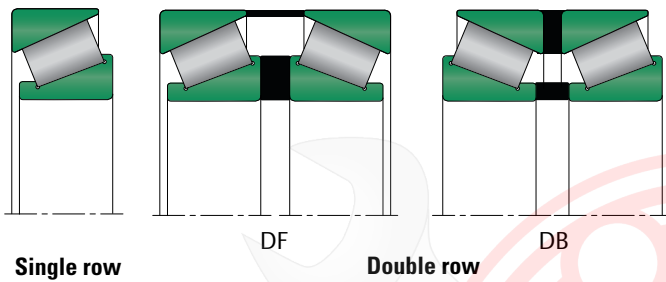

Single row

DF

Double row

DB

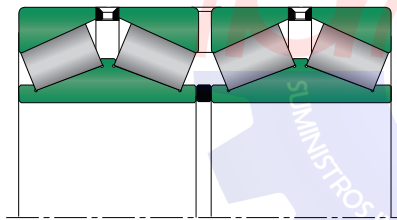

Four row

#### Angular Alignment

The following is an approximate guide to the misalignment that can be prevalent when fitting tapered roller bearings: 2 mins of arc. This is under normal loading conditions.



Deep Groove Ball Bearing	Self-Aligning Ball Bearing	Angular Contact Ball Bearing	
Cylindrical Roller Bearing	Tapered Roller Bearing	Spherical Roller Bearing	
Thrust Ball Bearing	Spherical Roller Thrust Bearing	Accessories Adapter & Withdrawal Sleeve	Technical & Related Information



# 9 | 0 | 0 | 1 | 0 | f

## Bearing characteristics - types and application

### Spherical Roller Bearing

In this design, two rows of rollers operate in separate raceways ground into the inner ring with guide rib to guide the rollers. The outer ring has a single spherical raceway, thus allowing the inner ring and rollers to freely compensate for angular errors due to inaccurate machine components or due to elastic deflection of the shaft or housing under load.

As a result of the line contact, a large number of rollers, and the substantial contact angle, these bearings have large radial and thrust load capacity. They are suitable for heavy shock and impact loads and thus are extensively used in steel mills, rock crushers, and heavy industrial equipment.



GMEX is the Excellence line for Rollway®'s Spherical Roller Bearings. Benefits are excellent load ratings, long service life, smooth running, low noise and vibrations and low maintenance cost. GMEX bearings are produced with a higher grade steel, enhanced heat treatment process, higher machining accuracy and better surface roughness.

C 2RS type is a sealed spherical roller bearing with a steel cage C and 2 NBR seals. High temperature seals 2VS are available as well. Sealed bearings are filled with lithium based grease. Due to the seal, misalignment is reduced. As well for some types the bearing with differs from the standard width.

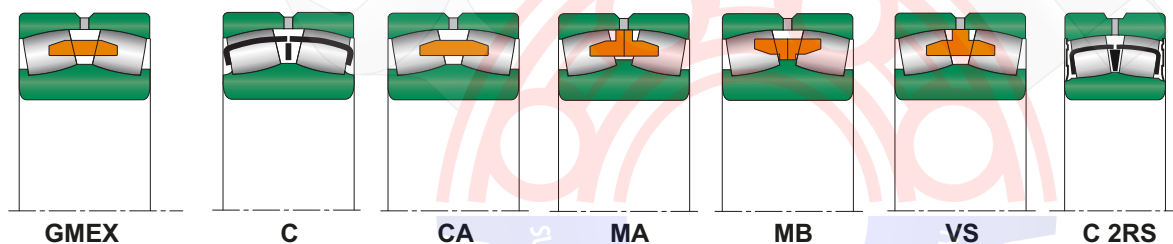

- GMEX** : 1 piece brass cage, roller guided between 2 inner ring flanges. Cage is guided on the rollers. Assymetrical roller position.
- C** : 2 pressed sheet steel cages, roller guided on a floating rings.
- CA** : 1 piece brass cage, roller guided between 2 inner ring flanges. Cage is guided on the rollers. Assymetrical roller position.
- MB** : 2 piece brass cage, roller guided between 2 inner ring flanges and one central rib. Cage is guided on the inner ring.
- VS C4 F80** : 1 piece brass cage, roller guided bür ring flanges. Cage is guided on the outer ring.
- MA C4 F80** : 2 piece brass cage, roller guided between 2 inner ring flanges and one central rib. Cage is guided on the outer ring.
- C 2RS** : Steel cage with 2 NBR seals

### Angular Misalignment

The following is an approximate guide to the misalignment that can be accommodated in a spherical roller bearing-between 1 and 2,5 degrees depending on which series is being used:

Bearing series	Permissible angular Misalignment degrees
213	1
222	1.5
223	2
230	1.5
231	1.5
232	2.5
240	2
241	2.5



Deep Groove Ball Bearing	Self-Aligning Ball Bearing	Angular Contact Ball Bearing	
Cylindrical Roller Bearing	Tapered Roller Bearing	Spherical Roller Bearing	
Thrust Ball Bearing	Spherical Roller Thrust Bearing	Accessories Adapter & Withdrawal Sleeve	Technical & Related Information



# 9 | 0 | 0 | 1 | 0 | h

## Bearing characteristics - types and application

### Thrust Ball Bearings

Thrust ball bearings are separable bearings. The single-acting thrust ball bearing consists of shaft washer, housing washer and ball set with cage, the double-acting type of a shaft washer (centre washer), two housing washer and two ball sets with cages.

Thrust ball bearings can be applied for high axial loads and low to medium speeds, they cannot, however, take radial loads. They are sensitive to angular deflection and characterized by extremely rigid guidance in axial direction. Depending on speed a minimum load is necessary to avoid sliding movements of the ball set, which are caused by centrifugal forces. To compensate for misalignments of the shaft, bearings with spherical housing washers and support washers should be used.

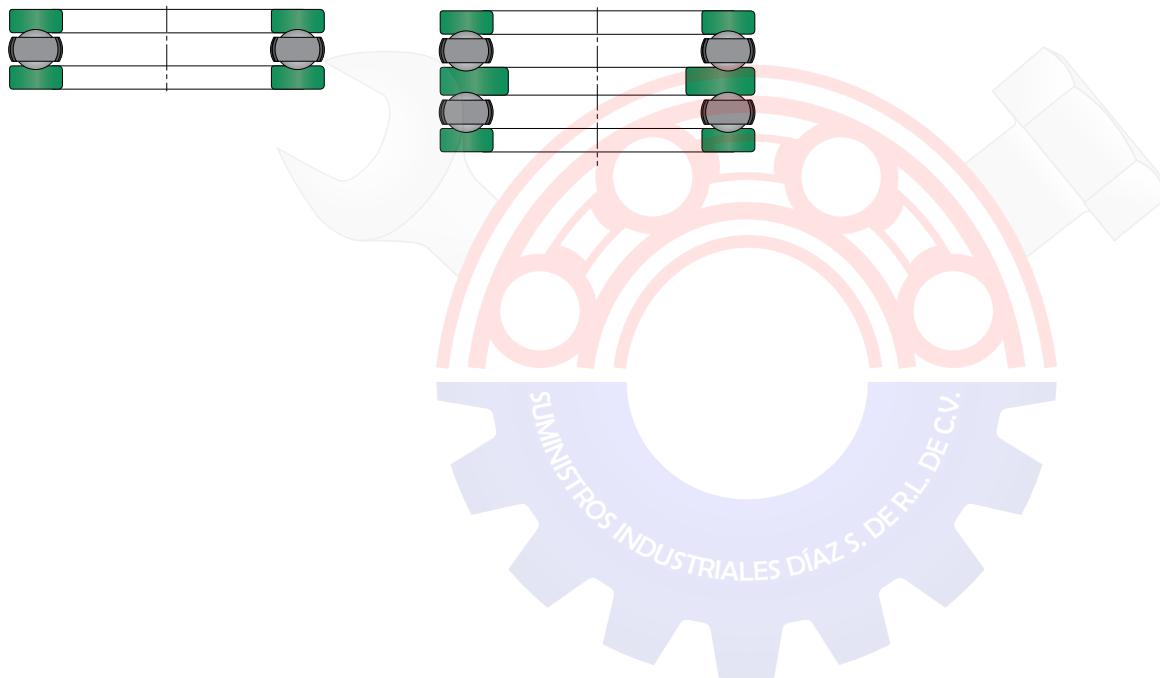



Deep Groove Ball Bearing	Self-Aligning Ball Bearing	Angular Contact Ball Bearing	
Cylindrical Roller Bearing	Tapered Roller Bearing	Spherical Roller Bearing	
Thrust Ball Bearing	Spherical Roller Thrust Bearing	Accessories Adapter & Withdrawal Sleeve	Technical & Related Information

# 9 0 0 2 0 a

## Bearing selection

Criteria



continue

The following procedure gives the steps to be followed when bearings are selected from the information contained in this catalog. It will be found satisfactory for most applications.

- Determine the speed of the bearing.  
Calculate the loads on the bearings.
- Establish if accurate alignment can be obtained between the bearing seatings. If it cannot, then bearings that accommodate misalignment should be selected.  
If the bearings rotate under load decide the life required, calculate the required dynamic load rating 'C' values, and then select suitable bearings that have comparable 'C' values.
- If the bearings do not rotate under load select them by using the static load rating 'C<sub>0</sub>'.
- Check if the bearings are suitable for the speed and decide of grease or oil is to be the lubricant.
- Select a suitable bearing arrangement of this is not already known; make sure that the seating fits required can be used with this arrangement.
- Decide if bearings to 'Standard' or 'Extra Precision' limits of accuracy are required.  
Select the most suitable range of radial clearance.  
Choose the abutment diameters.  
Choose suitable closures.  
Issue mounting and handling instructions for the bearings if necessary.

### Selecting Of Bearing Type

Each type of bearing has different properties, making it suitable for certain applications. The factors to be considered when choosing a bearing are numerous, so guidance is given to the main points when selecting a bearing. It must also be remembered that special consideration must be given to aspects relating to the running and operating, and to aspects relating to cases where at least one of the principal dimensions of the bearing has been determined by the machine design or shaft size.

### Load And Direction Of Load

The magnitude and direction of the external loads, along with built in factors of safety, are two of the main points which determine the bearing size - and in some instances - the bearing type to be used. The important factors are the speed of rotation, temperature, the amount of precision required, mounting conditions, and running noise.

The following illustrations indicate the magnitude and direction of the external loads which the bearings will provide for.

### Radial Loads

For light and medium radial loads, ball bearings are generally used; whereas for heavy loads and large shaft diameters, roller bearings are often the only choice.

Cylindrical roller bearings are available in several types. Types NU (with outer ring ribs), and N (with inner ring ribs) are only suitable for radial loads, whereas the NUP, NJ, and NJ with angle ring HJ can be used to a certain extent to take combined loads.

### Thrust Loads

Thrust ball bearings are only suitable for light or medium purely axial loads. Double-acting thrust ball bearings can carry thrust loads in either direction. Spherical roller thrust bearings are used where heavy thrust loads are to be absorbed, and in addition can carry a certain amount of radial load acting simultaneously.

### Combined Loads

If a radial and thrust load act on a bearing simultaneously, this is termed as a 'Combined Load'. The most important feature affecting the ability of carry axial loads is the angle of contact in relation to the shaft axis. The greater the angle, the more suitable the bearing is to accommodate axial loading. Combined loads are carried by deep groove ball bearings, self aligning ball bearings, four point bearings, single and double row angular contact bearings, spherical roller bearings, cylindrical roller bearing of the locating types and taper roller bearings.



Deep Groove Ball Bearing	Self-Aligning Ball Bearing	Angular Contact Ball Bearing	
Cylindrical Roller Bearing	Tapered Roller Bearing	Spherical Roller Bearing	
Thrust Ball Bearing	Spherical Roller Thrust Bearing	Accessories Adapter & Withdrawal Sleeve	Technical & Related Information

# 9 | 0 | 0 | 2 | 0 | b

## Bearing selection

Criteria

[◀ back](#)

### Limiting Speed

The speeds at which bearings can rotate are limited by the bearing type, the operating load and the permissible operating temperature of the lubricant.

Bearings with low frictional resistance, and correspondingly low internal heat generation, are most suitable for high speeds with proper attention being given to the correct bearing clearance after mounting.

For radial loads the bearings most suitable are deep groove ball bearings or cylindrical roller bearings. For combined loads angular contact bearings should be selected.

### Misalignment

Self aligning ball bearings, spherical roller bearings and spherical roller thrust bearings allow, at assembly, for the correction of misalignment where the shaft can be misaligned relative to the housing. Values for permissible angular misalignment are listed in the tables which precede the bearing sizes of those particular types.

### Low Noise Level

Even though the running noise of rolling bearings is so low that it is lost in the background noise of other moving parts. It is sometimes of prime importance to reduce this to a minimum level for electric motors used, for example, in lifts for hospitals and hotels, and other domestic appliances. Such applications usually demand the fitting of a deep-groove ball bearing selected for low noise level.

### Rigidity

This is sometimes a very important requirement, especially on machine tool spindles, where rigidity controls the bearing selection. In applications of this nature, single or double row cylindrical roller bearings or taper roller bearings are best suited, compared with the point contact of ball bearings. The stiffness can be further enhanced by pre-loading.

### Axial Movement

In a normal bearing arrangement supporting a shaft, it is usual to locate one bearing (fixed) and allow the non locating bearing (free) to float in the housing, thus preventing axial pre-load as a result of thermal expansion of the shaft. Axial movement produced by thermal expansion can be accommodated by the use of a cylindrical roller bearing of the N or NU pattern. This allows axial movement to occur by displacement of the rollers over the track.

### Tapered Bore And Sleeve Mounting

Tapered bore bearings are used for easier mounting and adjustments of the radial clearance. It is usual to fit sleeve bearings on a bright drawn steel bar, thus cutting machining costs and simplifying assembly. Withdrawal sleeves are used to ease the removal of the bearing. The residual clearance should be checked with the tables relating to the axial drive-up for spherical roller bearings and the bearing size.

### Precision

Rolling bearings with a higher degree of precision than normal are required for shafts where running accuracy is of prime importance - for example, machine tools spindles and shafts rotating at very high speeds (see section relating to bearing tolerances).



Deep Groove Ball Bearing	Self-Aligning Ball Bearing	Angular Contact Ball Bearing	
Cylindrical Roller Bearing	Tapered Roller Bearing	Spherical Roller Bearing	
Thrust Ball Bearing	Spherical Roller Thrust Bearing	Accessories Adapter & Withdrawal Sleeve	Technical & Related Information



# 9 0 0 3 0 a

## Bearing life calculation

### Introduction-bearing size

continue

### Determination Of Rolling Bearing Size

To determine the size of the bearing, static and dynamic load conditions and design life requirements must be considered. The load ratings for the size and type are given in the bearing tables on the appropriate pages.

#### Dynamic Loading

When a batch of apparently identical bearings is tested under identical load, speed, and operating conditions, a wide difference is obtained in the lives of the bearings. Typical results are plotted below - this graph shows the 'rating life' (sometimes called the 90% survival life). This is the calculated life obtained by following the procedure set out in this catalogue. Also shown is the average life, which is appreciably greater than the 'rating life'.

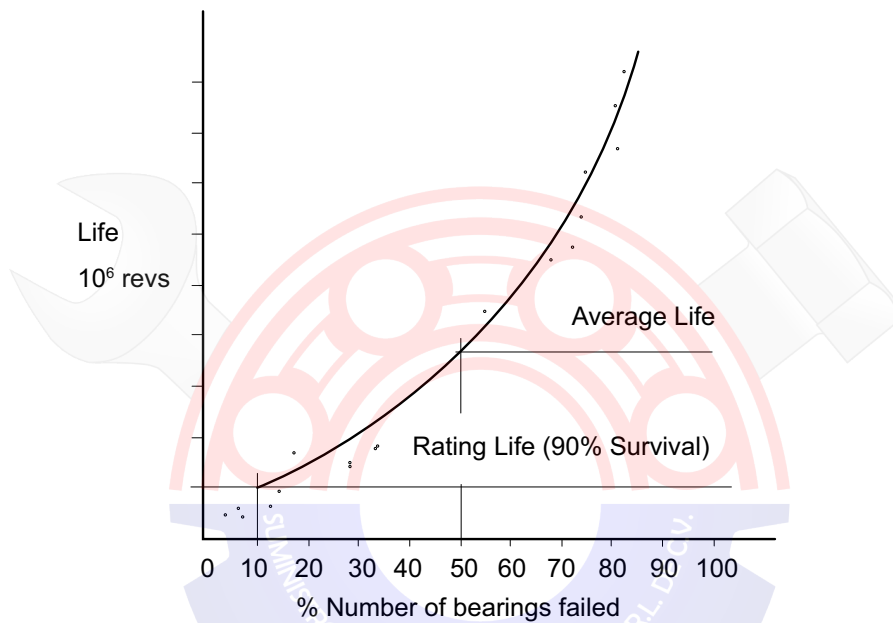

The required basic static load rating  $C_0$  of a bearing can be determined using the equation:

$$C_0 = S_0 P_0$$

where:

$C_0$  = basic load rating [kN]

$P_0$  = equivalent static load [kN]

$S_0$  = static safety factor

For bearings operating in elevated temperatures, the hardness of the bearing material will be reduced.

The reason for this difference is that even with the best steel, minute imperfections exist in the material. As the area of contact between the rolling elements and rings under load is very small, these imperfections upset the distribution and intensity of stress in the material variations in contact area, resulting from the manufacturing tolerances on the rings and rolling elements, also contribute towards this difference.

In addition to the load conditions on a bearing, failure can also result from other factors - notably, lack of attention to lubrication, protection, or accuracy of mounting. These cannot be included in the basic load/life formulae.



Deep Groove Ball Bearing	Self-Aligning Ball Bearing	Angular Contact Ball Bearing	
Cylindrical Roller Bearing	Tapered Roller Bearing	Spherical Roller Bearing	
Thrust Ball Bearing	Spherical Roller Thrust Bearing	Accessories Adapter & Withdrawal Sleeve	Technical & Related Information

# 90030C

## Bearing life calculation

### Introduction-safety factor & life rating



◀ back continue ▶

### Safety factor $S_o$

Values of  $S_o$  for a few typical non-rotating bearing applications are shown below and may be used as a guide.

Application	$S_o$ Factor
Variable pitch propeller	0.5
Dams on aircraft	1.0
Swing bridges	1.5
Crane hooks for large cranes without additional dynamic forces	1.5
Small cranes for bulk goods with large additional dynamic forces	1.6

On rotating bearings where the load fluctuates dramatically, or where heavy shock loads occur during a fraction of a revolution, it is necessary to check that the basic static load rating is adequate. Heavy shock loads could cause permanent deformation, in the form of indentation being unevenly distributed over the raceway. Shock loads are also generally such that they cannot be calculated exactly. In some cases, they may also cause deformation of the housing, producing unfavorable load distribution. Depending on the operating conditions, the maximum load should not exceed a value determined by the static safety factor  $S_o$ .

Operating Conditions	$S_o$ Factor (min)
Operation is smooth and vibration free	0.5
Operation is normal and vibration conditions normal	1.0
Pronounced shock loads	1.5 – 2
Demand on smooth running is of prime importance	2.0
For spherical roller thrust bearing	$\geq 4$

### Basic Dynamic Load Rating $C_r$

Basic dynamic load rating ( $C_r$ ) is defined as that constant radial load which a group of apparently identical radial ball bearings, angular contact ball bearings, and radial roller bearings can endure for a rating life of one million revolutions.

For thrust ball bearings the basic dynamic load rating is that constant, central, axial load which a group of apparently identical thrust bearings can endure for a rating life of one million revolutions.

### Static Load Rating $C_o$

The static load  $C_o$  is defined as a load acting on a non-rotating bearing. Permanent deformations appear in rolling elements and raceways under static load of moderate magnitude and increase gradually with increasing load. The permissible static load is, therefore, dependent upon the permissible magnitude of permanent deformation.

Experience shows that a total permanent deformation of 0.0001 of the rolling element diameter, occurring at the most heavily loaded rolling element and raceway contact, can be tolerated in most bearing applications without impairment of bearing operation.

### Rating Life

Rating life ( $L$ ) is defined as the number of revolutions (or hours at some constant speed) that 90% of a group of apparently identical bearings will exceed before the first evidence of fatigue develops. This may be referred to as B10 life.





Deep Groove Ball Bearing	Self-Aligning Ball Bearing	Angular Contact Ball Bearing	
Cylindrical Roller Bearing	Tapered Roller Bearing	Spherical Roller Bearing	
Thrust Ball Bearing	Spherical Roller Thrust Bearing	Accessories Adapter & Withdrawal Sleeve	Technical & Related Information



# 9 0 0 3 0 e

## Bearing life calculation

### Life equation

◀ back continue ▶

The expression  $L_u = (C/P)^p [10^6 \text{ revs}]$  is used to establish a mathematical relationship for the rating life as a function of the load where:

$L_u$  = rating life in millions of revolutions of the inner ring with constant direction of loading

$C$  = basic dynamic load rating in [kN]

$P$  = equivalent dynamic load rating in [kN]

$p$  = exponent for life equation, where as:

$p = 3$  for ball bearings

$p = 10/3$  for roller bearings

In most cases it is common practice to employ the rating life  $L_h$  (hours).  
The relationship between  $L_u$  and  $L_h$  with constant rotational speed  $n$  (rpm) is

$$L_u = \frac{L_h \cdot n \cdot 60}{10^6} [10^6 \text{ revs}]$$

If the rating life of  $1 \times 10^6$  revs, to which the basic load rating  $C$  refers, is resolved into a reference life  $L_h = 500$  hours, and a reference rotation speed of  $n = 33.1/3$  rpm it follows that:

For ball bearings:  $\left(\frac{C}{P}\right)^3$

$$L_u = \frac{L_h \cdot n \cdot 60}{500 \cdot 33.1/3 \cdot 60} = \left(\frac{C}{P}\right)^3 [10^6 \text{ revs}]$$

or: 
$$\sqrt[3]{\frac{L_h}{500}} = \sqrt[3]{\frac{33.1/3}{n} \cdot \frac{C}{P}}$$

letting: 
$$\sqrt[3]{\frac{33.1/3}{n}} = \text{speed factor } f_n \quad (\text{equation 1})$$

and: 
$$\sqrt[3]{\frac{L_h}{500}} = \text{life factor } f_L \quad (\text{equation 2})$$

The rating life equation may be obtained in the form life factor:  $f_L = \frac{C}{P} f_n$

Basic load rating required:  $C = \frac{P f_L}{f_n} [KG]$

The relationship of equation 1 and 2 are graphically represented the nomograms shown on page 90030K. Also on page 90030h are charts showing the  $L_{10}$  life in relation to  $C/P$  for ball and roller bearings.



Deep Groove Ball Bearing	Self-Aligning Ball Bearing	Angular Contact Ball Bearing	
Cylindrical Roller Bearing	Tapered Roller Bearing	Spherical Roller Bearing	
Thrust Ball Bearing	Spherical Roller Thrust Bearing	Accessories Adapter & Withdrawal Sleeve	Technical & Related Information

## 9 | 0 | 0 | 3 | 0 | h

## Bearing life calculation

Life table (millions of revolutions)



◀ back continue ▶

L <sub>10</sub>	C / P		L <sub>10</sub>	C / P		L <sub>10</sub>	C / P	
	Ball bearings	Roller bearings		Ball bearings	Roller bearings		Ball bearings	Roller bearings
0.5 0.75 1	0.793 0.909 1.00	0.812 0.917 1.00	240 260 280	6.21 6.38 6.54	5.18 5.30 5.42	2 000 2 200 2 400	12.6 13.0 13.4	9.78 10.1 10.3
1.5 2 3	1.14 1.26 1.44	1.13 1.24 1.39	300 320 340	6.69 6.84 6.98	5.54 5.61 5.75	2 600 2 800 3 000	13.8 14.1 14.4	10.6 10.8 11.0
4 5 6	1.59 1.71 1.82	1.52 1.62 1.71	360 380 400	7.11 7.24 7.37	5.85 5.94 6.03	3 200 3 400 3 600	14.7 15.0 15.3	11.3 11.5 11.7
8 10 12	2.00 2.15 2.29	1.87 2.00 2.11	420 440 460	7.49 7.61 7.72	6.12 6.21 6.29	3 800 4 000 4 500	15.6 15.9 16.5	11.9 12.0 12.5
14 16 18	2.41 2.52 2.62	2.21 2.30 2.38	480 500 550	7.83 7.94 8.19	6.37 6.45 6.64	5 000 5 500 6 000	17.1 17.7 18.2	12.9 13.2 13.6
20 25 30	2.71 2.92 3.11	2.46 2.63 2.77	60 650 700	8.43 8.66 8.88	6.81 6.98 7.14	6 500 7000 7500	18.7 19.1 19.6	13.9 14.2 14.5
35 40 45	3.27 3.42 3.56	2.91 3.02 3.13	750 800 850	9.09 9.28 9.47	7.29 7.43 7.56	8 000 8 500 9 000	20.0 20.4 20.8	14.8 15.1 15.4
50 60 70	3.68 3.91 4.12	3.23 3.42 3.58	900 950 1 000	9.65 9.83 10.0	7.70 7.82 7.94	9 500 10 000 12 000	21.2 21.5 22.9	15.6 15.8 16.7
80 90 100	4.31 4.48 4.61	3.72 3.86 3.98	1 100 1 200 1 300	10.3 10.6 10.9	8.17 8.39 8.59	14 000 16 000 18 000	24.1 25.2 26.2	17.5 18.2 18.9
120 140 160	4.93 5.19 5.43	4.20 4.40 4.58	1 400 1 500 1 60	11.2 11.4 11.7	8.79 8.97 9.15	20 000 25 000 30 000	27.1 29.2 31.1	19.5 20.9 22.0
180 200 220	5.65 5.85 6.04	4.75 4.90 5.04	1 700 1 800 1 900	11.9 12.2 12.4	9.31 9.48 9.63	- - -	- - -	- - -



Deep Groove Ball Bearing	Self-Aligning Ball Bearing	Angular Contact Ball Bearing	
Cylindrical Roller Bearing	Tapered Roller Bearing	Spherical Roller Bearing	
Thrust Ball Bearing	Spherical Roller Thrust Bearing	Accessories Adapter & Withdrawal Sleeve	Technical & Related Information



# 9 | 0 | 0 | 3 | 0 | k

## Bearing life calculation

### Nomogram nominal life

◀ back continue ▶

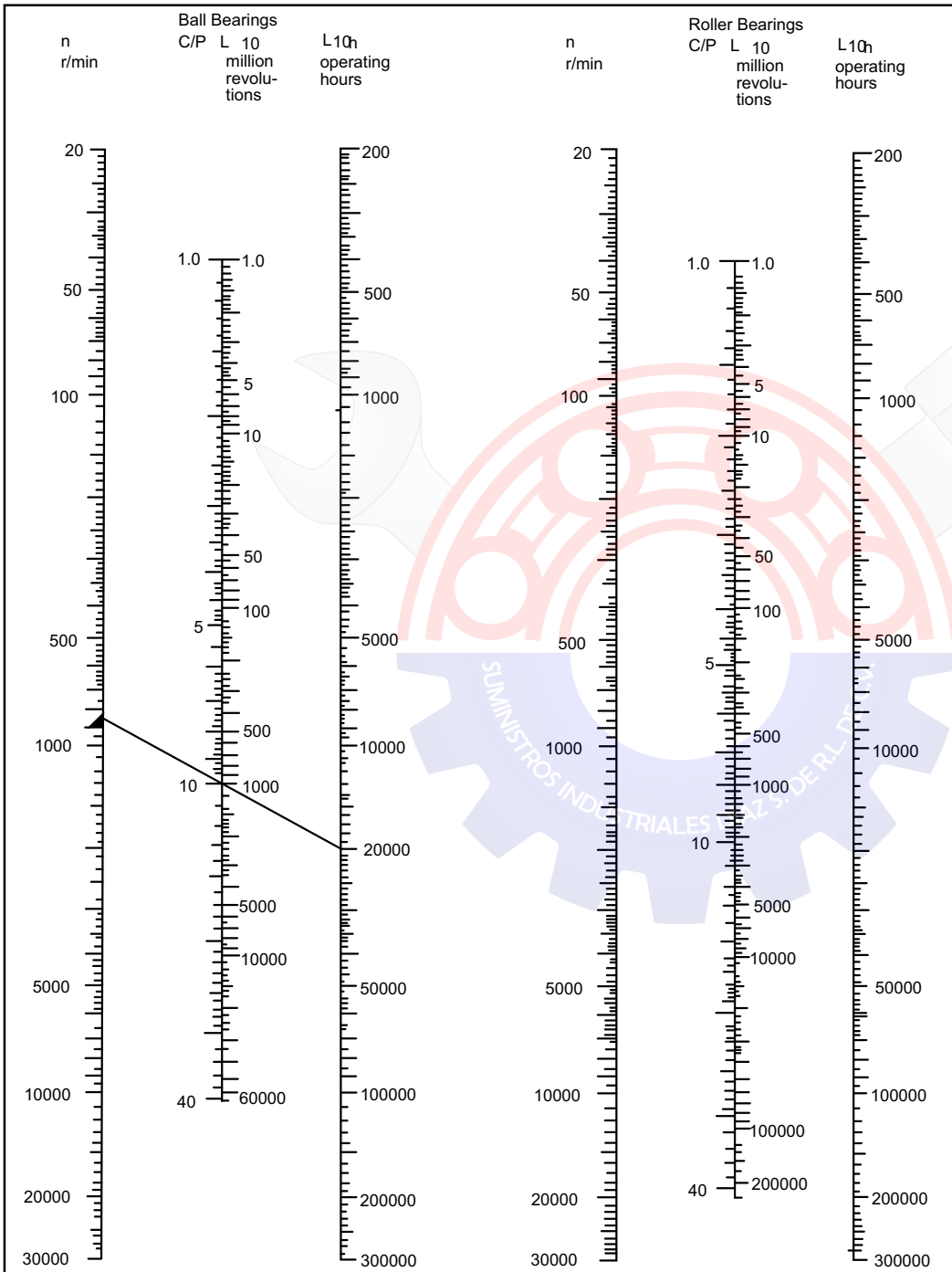



Deep Groove Ball Bearing	Self-Aligning Ball Bearing	Angular Contact Ball Bearing	
Cylindrical Roller Bearing	Tapered Roller Bearing	Spherical Roller Bearing	
Thrust Ball Bearing	Spherical Roller Thrust Bearing	Accessories Adapter & Withdrawal Sleeve	Technical & Related Information



## 9 | 0 | 0 | 3 | 0 | m

## Bearing life calculation

### Nominal life calculation

◀ back continue ▶

To determine the size of a rolling bearing for a particular field of operation, it is necessary to establish the nominal life corresponding to the field of application.

#### Example

A deep groove ball bearing is required to run at speed  $n=850$  RPM under constant radial load of  $f_r = 5$  kN and is to achieve a basic rating life  $L_{10h}$  of 20.000 hours.

From the nomogram (page 90030k) using the right hand column ( $L_{10}$ ), a line drawn from 20.000 to the left hand column ( $n$  RPM) passes through the centre column (C/P  $L_{10}$  10.6) at 10:1000. Therefore, a bearing is required with a basic load rating C of at least  $C = 10 \times 5$  kN. Reading from the tables relating to deep groove ball bearings, it can be seen that a bearing ref 6309 has a C value of 52.7 kN. Of course, the choice of bearing is also governed by the shaft and housing parameters.

For motor vehicles and rolling stock, the service life is expressed as a function of the wheel diameter and kilometers traveled as per formulae below:

$$L_{10} = \frac{1000}{\pi D} \cdot L_{10s}$$

or

$$L_{10s} = \frac{\pi D}{1000} L_{10}$$

where:

$L_{10}$  = nominal life in  $10^6$  RPM

$L_{10s}$  = life in  $10^6$  kilometers traveled

$D$  = diameter of wheel in meters. Values for selecting service life in kilometers covered are in table below.

Vehicle type	$L_{10s}/10^6$ km
Wheel bearings for motor vehicles:	
cars	0.2
trucks, buses	0.4
Axle boxes for rolling stock – freight cars	0.8
Suburban traffic	1.5
Long distance coaches	3
Rail cars	3 - 1
Diesel and electric locomotives	3 - 4

Depending on the working temperature of the bearings, their service life is reduced at elevated temperatures.

This is to be taken into consideration when the service life is established by the application of temperature factor  $f_t$  specified in the table below:

Working temperature °C	150	200	250	300
Working temperature °F	302	392	482	572
Symbol	S0	S1	S2	S3
$f_t$	1	0.73	0.42	0.22



Deep Groove Ball Bearing	Self-Aligning Ball Bearing	Angular Contact Ball Bearing	
Cylindrical Roller Bearing	Tapered Roller Bearing	Spherical Roller Bearing	
Thrust Ball Bearing	Spherical Roller Thrust Bearing	Accessories Adapter & Withdrawal Sleeve	Technical & Related Information

# 9 | 0 | 0 | 3 | 0 | n

## Bearing life calculation

### Life factors fv and fL



◀ back continue ▶

In the following table are some recommendations for factor fv along with typical applications and life factor fL

Application	Fields of operating conditions	Factor fv	Factor fL
Motor vehicles - gear boxes - axle drives - water pumps - wheel bearings	g – k h – k k h – l	3 – 8 3 – 6 5 – 7 4 – 6	1.7 – 2.2 2 – 3 1.5 – 2 1.6 – 2.5
Railbound vehicles - haulage trolleys - trams - passenger coaches and freight cars - motor coaches and locomotives - gears	f – h e – f c – d d – e c – d	12 – 15 8 – 12 8 – 12 6 – 10 3 – 6	2.5 – 3 3.5 – 4 3 – 3.5 3.5 – 4 3 – 4.5
Motors - electric motors for household appliances - traction motors and standard motors - large motors	i – k c – d b – d	3 – 5 3 – 5 3 – 5	1.5 – 2 3.5 – 4.5 4 – 4.5
Machine-tools - lathe spindles and milling spindles - boring and grinding machine spindles - machine tool gears - electric and pneumatic tools	a – b c – d c – d g – h	0.5 – 1.5 0.5 – 1 3 – 8 3 – 6	3 – 4.5 2.5 – 3.5 3 – 4 1.8 – 2.7
Woodworking machines - milling cutter and cutter shaft - main bearing - rod bearing	e – f e – g c – d	0.5 – 3 3 – 4 2 – 3	3 – 4 3 – 4 2 – 3
Gears general engineering - universal gears - large-sized gears, stationary	d – c c – d	3 – 1 2 – 3	2 – 3 2 – 3
Materials handling - belt drives opencast mining - medium-sized and large fans - centrifugal pumps and compressors	c – d c – l d – f	5 – 12 3 – 5 3 – 5	4 – 6 3 – 4.5 3 – 4.5
Crushers, mills, screens etc. - jaw crushers, roll crushers	f – g	8 – 12	3 – 3.5
Hammer mills - hammer mills and impact mills - tube mills - vibrating mills - vibrating screens	d – c f – g f – g e – f	5 – 8 12 – 18 3 – 5 4 – 6	3.5 – 4.5 3 – 5 2 – 3 2.5 – 3



Deep Groove Ball Bearing	Self-Aligning Ball Bearing	Angular Contact Ball Bearing	
Cylindrical Roller Bearing	Tapered Roller Bearing	Spherical Roller Bearing	
Thrust Ball Bearing	Spherical Roller Thrust Bearing	Accessories Adapter & Withdrawal Sleeve	Technical & Related Information



## 9 | 0 | 0 | 3 | 0 | r

### Bearing life calculation

#### Adjusted rating life

◀ back continue ▶

The wear life diagram indicates the operating conditions, with the least wear factor at curve A and the heaviest wear occurring at curve B. The area between A and B is subdivided into individual fields from a to k. It can be seen that the operating conditions deteriorate progressively.

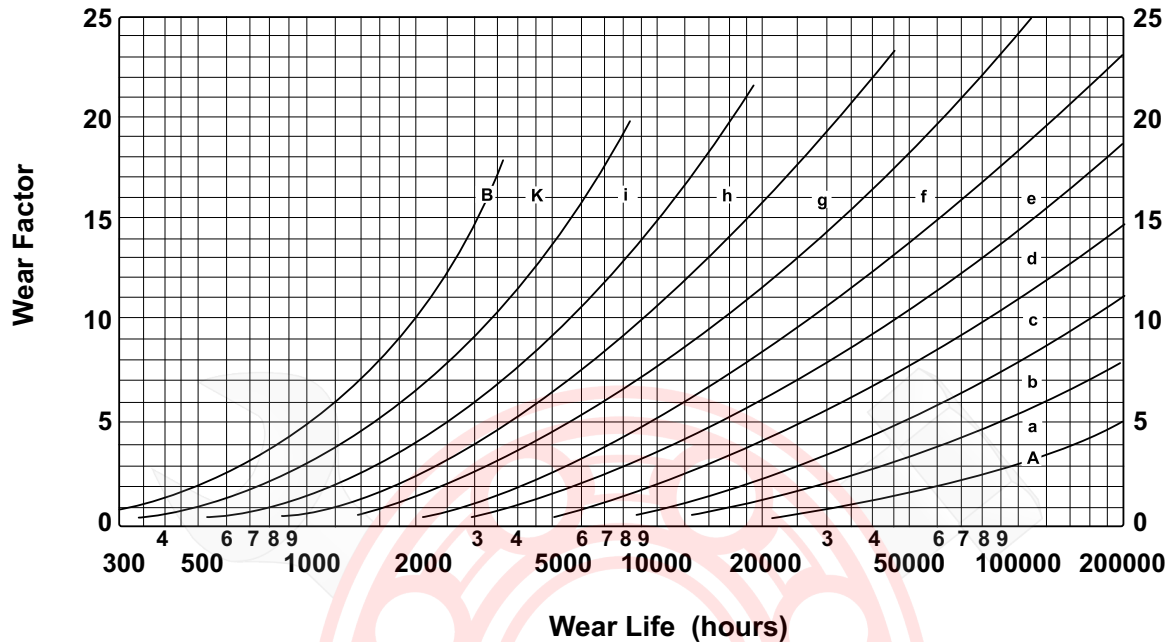

Adjusted rating life  
Adjustments to life equations

$$L_{10} = \left( \frac{C}{P} \right)^p$$

The above formula is adequate for conventional applications, but in exceptional cases other factors must be considered which influence the life of the bearing. To accommodate these factors, the ISO life equation is:

$$L_{na} = a_1 \cdot a_2 \cdot a_3 \cdot \left( \frac{C}{P} \right)^p$$

or

$$L_{na} = a_1 \cdot a_2 \cdot a_3 \cdot L_{10}$$

where:

$L_{na}$  = adjusted rating life in  $10^6$  revolutions the index being the difference between the specified probability life and 100%

$a_1$  = life adjustment factor for reliability

$a_2$  = life adjustment for material

$a_3$  = life adjustment for operating conditions

Calculations for the adjusted rating life are based on the pre-conditions mentioned in the above formulae; for example, that bearing loads can be calculated with accuracy considering all aspects of the loads involved along with shaft deflection etc.

Also, that reliability of the bearing materials are in accordance with the corresponding C values and that normal operating conditions  $a_1 = a_2 = a_3 = 1$  and that two life equations become identical.



Deep Groove Ball Bearing	Self-Aligning Ball Bearing	Angular Contact Ball Bearing	Technical & Related Information
Cylindrical Roller Bearing	Tapered Roller Bearing	Spherical Roller Bearing	
Thrust Ball Bearing	Spherical Roller Thrust Bearing	Accessories Adapter & Withdrawal Sleeve	



# 90030s

## Bearing life calculation

### Life adjustment factors

◀ back continue ▶

#### Life Adjustment Factor $a_1$ For Reliability

The  $a_1$  factor is used to determine lives which are obtained or exceeded with a greater probability than 90% (L10). The table below lists the factors for failure probability values between 10% and 1% L10 being the normal rating life.

Probability %	Failure probability %	Life before fatigue appears	Factor $a_1$
90	10	L10	1
95	5	L5	0.62
95	4	L4	0.53
97	3	L3	0.44
98	2	L2	0.33
99	1	L1	0.21

#### Life Adjustment Factor $a_2$ For Material

The factor  $a_2$  accounts for the properties of the material and its heat treatment.  $a_2=1$  is applicable to the high quality steels used in the production of normal bearing series.

#### Life Adjustment Factor $a_3$ For Operating Conditions

The operating condition factor  $a_3$  is primarily determined by bearing lubrication, providing bearing temperatures are not excessive. For elevated temperatures, see reduction in dynamic load rating in table below.

Working temperature °C	150	200	250	300
Working temperature °F	302	392	482	572
Symbol	S0	S1	S2	S3
ft	1	0.73	0.42	0.22

The efficiency of lubrication is determined primarily by the degree of separation between the rolling elements and raceways. The highest life values are reached when there is a hydrodynamic state of lubrication (where metal to metal contact does not exist between rolling elements and raceway), and under the cleanliness conditions which would normally prevail in an adequately sealed bearing arrangement. The  $a_3$  factor is based on the viscosity ratio K – this is defined as the ratio of the actual lubricant viscosity V for the viscosity  $v_1$  required for adequate lubrication. With thinner lubricating films, there is an increase in metal to metal contact and life expectancy decreases.

#### Life Adjustment Factor $a_{23}$

Since  $a_2$  and  $a_3$  factors are interdependent, the factor combination  $a_{23}$  is used.

$$a_{23} = a_2 \cdot a_3$$

and

$$Lna = a_1 \cdot a_{23} \cdot L [10^6 \text{ revs}]$$



Deep Groove Ball Bearing	Self-Aligning Ball Bearing	Angular Contact Ball Bearing	
Cylindrical Roller Bearing	Tapered Roller Bearing	Spherical Roller Bearing	
Thrust Ball Bearing	Spherical Roller Thrust Bearing	Accessories Adapter & Withdrawal Sleeve	Technical & Related Information

# 9 | 0 | 0 | 3 | 0 | t

## Bearing service life calculation

Service Life



◀ back

Since the fatigue life modified by the adjustment factors  $a_1$ ,  $a_2$ , and  $a_3$  only considers material fatigue as the cause of failure, the calculated life corresponds to the service life only if the following points are met:

- (a) Lubrication conditions are constant throughout.
- (b) Loads and speeds used for analysis are a true reflection of the actual operating conditions.
- (c) Operating viscosity is based on actual operating temperature.
- (d) Lubricant contamination is limited during the whole running time.
- (e) The service life limited by wear and break down of lubrication is not shorter than the fatigue life.

Wear of the acting surfaces is primarily caused by contamination which, over a period of time, may penetrate the bearing. The situation is made worse by inadequate lubrication and corrosion due to condensation. The amount of wear experienced in a bearing is dependant on the operating conditions, lubrication, and effective sealing arrangement.

### Wear Factor

$$fv = \frac{v}{e_0}$$

The permissible amount of wear is expressed by the wear factor  $fv$ .

where:

$v$  = permissible increase in radial clearance (mm)

$e_0$  = bearing constant depending on the bore diameter – see below for

$e_0$  values in relationship with bore diameter mm.







Deep Groove Ball Bearing	Self-Aligning Ball Bearing	Angular Contact Ball Bearing	Technical & Related Information
Cylindrical Roller Bearing	Tapered Roller Bearing	Spherical Roller Bearing	
Thrust Ball Bearing	Spherical Roller Thrust Bearing	Accessories Adapter & Withdrawal Sleeve	



# 9 0 0 3 1 a

## Equivalent load calculation

### Deep Groove Ball Bearings

#### Equivalent Dynamic Load

$$P = XFr + YF a \quad [kN]$$

The factors X and Y depend upon the ratio  $Fa/Co$ . (The relationship of the axial load to the basic static load) the values shown in the table are applicable to bearings mounted with normal fits – shafts machined to j5 or k5 and housings to J6.



Other dynamic & static load calculation  
Go to:



#### Equivalent Static Load

$$Po = Fr \quad \text{when} \quad Fa / Fr \leq 0.8 \quad [kN]$$

$$Po = 0.6Fr + 0.5Fa \quad \text{when} \quad Fa / Fr \geq 0.8 \quad [kN]$$

Calculation factors X and Y for deep groove ball bearings:

Fa/Co	Normal radial clearance					Radial clearance C3					Radial clearance C				
	Fa / Fr ≤ e			Fa / Fr > e		Fa / Fr ≤ e			Fa / Fr > e		Fa / Fr ≤ e			Fa / Fr > e	
	e	X	Y	X	Y	e	X	Y	X	Y	e	X	Y	X	Y
0.025	0.22	1	0	0.56	1.2	0.31	1	0	0.46	1.75	0.4	1	0	0.44	1.12
0.04	0.24	1	0	0.56	1.8	0.33	1	0	0.46	1.62	0.42	1	0	0.44	1.36
0.07	0.27	1	0	0.56	1.6	0.36	1	0	0.46	1.46	0.44	1	0	0.44	1.27
0.13	0.31	1	0	0.56	1.4	0.41	1	0	0.46	1.3	0.48	1	0	0.44	1.16
0.25	0.37	1	0	0.56	1.2	0.46	1	0	0.46	1.14	0.53	1	0	0.44	1.05
0.5	0.44	1	0	0.56	1	0.54	1	0	0.46	1	0.56	1	0	0.44	1

#### Axial Loading Capacity

If deep groove ball bearings are axially loaded this should generally not exceed 0.5 Co. For small bearings and light series the axial load should not exceed 0.25 Co.



Deep Groove Ball Bearing	Self-Aligning Ball Bearing	Angular Contact Ball Bearing	
Cylindrical Roller Bearing	Tapered Roller Bearing	Spherical Roller Bearing	
Thrust Ball Bearing	Spherical Roller Thrust Bearing	Accessories Adapter & Withdrawal Sleeve	Technical & Related Information



# 9 0 0 3 2 a

## Equivalent load calculation

### Double Row Self Aligning Ball Bearings

#### Equivalent Dynamic Load

$$P = Fr + Y_1 Fa \quad \text{when} \quad Fa/Fr \leq e$$

$$P = 0.65 Fr + Y_2 Fa \quad \text{when} \quad Fa/Fr > e$$

The values for  $Y_1$ ,  $Y_2$  and  $e$  are given in the bearing tables.

#### Equivalent Static Load

$$Po = Fr + Y_0 Fa$$

The  $Y_0$  values are given in the bearing tables.

#### Axial Load Capacity When Mounted On Adapter Sleeves

When double row self aligning ball bearings are mounted on adapter sleeves fitted on smooth shafts, the axial load the bearing will carry depends on the friction between the sleeve bore and the shaft. The allowable axial load can be calculated by the formula

$$Faz = 3 \cdot B \cdot d$$

where:

$Faz$  = maximum allowable axial load (N)

$B$  = bearing width (mm)

$d$  = bore diameter (mm)



Other dynamic & static load calculation  
Go to:



Deep Groove Ball Bearings



Angular Contact Ball Bearings



Cylindrical Roller Bearings



Tapered Roller Bearings



Spherical Ball Bearings



Thrust Ball Bearings



Thrust Spherical Roller Bearings

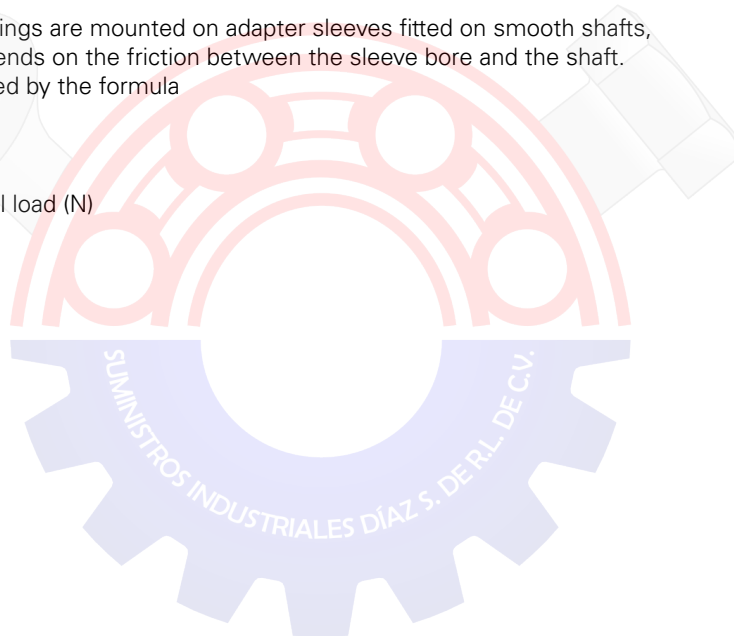



Deep Groove Ball Bearing	Self-Aligning Ball Bearing	Angular Contact Ball Bearing	Technical & Related Information
Cylindrical Roller Bearing	Tapered Roller Bearing	Spherical Roller Bearing	
Thrust Ball Bearing	Spherical Roller Thrust Bearing	Accessories Adapter & Withdrawal Sleeve	



# 9 0 0 3 3 a

## Equivalent load calculation

### Single Row Angular Contact Bearings

continue

For single row angular contact ball bearings (series 72B and 73B) with contact angle of 40°, the following relations apply:

#### Single and tandem mounted bearings:

$$P = F \quad \text{when: } Fa/Fr \leq 1.14$$

$$P = 0.35 Fr + 0.57 Fa \quad \text{when: } Fa/Fr > 1.14$$

#### Bearing pairs arranged back to back or face to face:

$$P = Fr + 0.55 Fa \quad \text{when: } Fa/Fr \leq 1.14$$

$$P = 0.57 Fr + 0.93 Fa \quad \text{when: } Fa/Fr > 1.14$$

Paired bearings, Fr and Fa are the loads acting on the pair.

Since the loads are transmitted from one raceway to the other in an inclined position, radial loads induce axial reaction forces which must be considered when calculating the equivalent dynamic load. For calculation purposes, the equations show where bearing A and bearing B are subjected to a radial load Fr A and Fr B, respectively, and are always considered positive even when they act in the opposite direction to that shown in the figures. The radial loads act at what is termed the "pressure center" of the bearings, which is given in the bearing tables as dimension "a". There is an external force Ka = 0; the equations are valid only if the bearings have been adjusted against each other to practically zero clearance and no preload.

#### Bearing arrangement and load equation

Face to Face	Back to Back
<p>1a) <math>F_{rA} \geq F_{rB}</math> <math>K_a \geq 0</math></p> <hr/> $F_{aA} = 1.14 F_{rA}$ $F_{aB} = F_{aA} + K_a$	<p>1b) <math>F_{rA} &lt; F_{rB}</math> <math>K_a = 1.14 (F_{rB} - F_{rA})</math></p> $F_{aA} = 1.14 F_{rA}$ $F_{aB} = F_{aA} + K_a$
<p>2a) <math>F_{rA} \leq F_{rB}</math> <math>K_a \geq 0</math></p> <hr/> $F_{aA} = F_{aB} + K_a$ $F_{aB} = 1.14 F_{rB}$	<p>1c) <math>F_{rA} &lt; F_{rB}</math> <math>K_a &lt; 1.14 (F_{rB} - F_{rA})</math></p> $F_{aA} = F_{aB} - K_a$ $F_{aB} = 1.14 F_{rB}$
<p>2b) <math>F_{rA} &gt; F_{rB}</math> <math>K_a \geq 1.14 (F_{rA} - F_{rB})</math></p> <hr/> $F_{aA} = F_{aB} + K_a$ $F_{aB} = 1.14 F_{rB}$	<p>2c) <math>F_{rA} &gt; F_{rB}</math> <math>K_a &lt; 1.14 (F_{rA} - F_{rB})</math></p> $F_{aA} = 1.14 F_{rA}$ $F_{aB} = F_{aA} - K_a$

Note: for double row angular contact ball bearings of 32 and 33 series with one piece inner ring:

$$P = Fr + 0.73 Fa \quad \text{when } Fa/Fr \leq 0.86$$

$$P = 0.62 Fr + 1.17 Fa \quad \text{when } Fa/Fr > 0.86$$

#### Equivalent Static Load

For single row angular contact ball bearings of the 72 B and 73 B series, for bearings mounted singly or paired in tandem:

$$P_o = 0.5 Fr + 0.26 Fa \quad \text{when } P_o < Fr \text{ } P_o = Fr \text{ should be used}$$

For bearing pairs arranged back to back or face to face:

$$P_o = Fr + 0.52 Fa \quad \text{when } Fr \text{ and } Fa \text{ are the loads acting on the pair of bearings}$$

Note: for double row angular contact bearings of 32 and 33 series with one piece inner ring:

$$P_o = Fr + 0.63 Fa$$



#### Other dynamic & static load calculation Go to:

- Deep Groove Ball Bearings
- Self Aligning Ball Bearings
- Cylindrical Roller Bearings
- Tapered Roller Bearings
- Spherical Ball Bearings
- Thrust Ball Bearings
- Thrust Spherical Roller Bearings



Deep Groove Ball Bearing	Self-Aligning Ball Bearing	Angular Contact Ball Bearing	
Cylindrical Roller Bearing	Tapered Roller Bearing	Spherical Roller Bearing	
Thrust Ball Bearing	Spherical Roller Thrust Bearing	Accessories Adapter & Withdrawal Sleeve	Technical & Related Information



# 9 0 0 3 3 b

## Equivalent load calculation

### Single Row Angular Contact Bearings

[back](#)

#### Equivalent Load Calculation Dynamic

Equivalent Dynamic Load $P = X Fr + Y Fa$			
Series	Contact angle	Single mounting / Tandem	Back to Back / Face to Face arrangement
7200/7300 (Single row)	40° Suffix B	$P = Fr$ when $Fa/Fr \leq 1,14$	$P = Fr + 0,55 Fa$ when $Fa/Fr \leq 1,14$
		$P = 0,35 Fr + 0,57 Fa$ when $Fa/Fr > 1,14$	$P = 0,57 Fr + 0,93 Fa$ when $Fa/Fr > 1,14$
	25° Suffix A	$P = Fr$ when $Fa/Fr \leq 0,68$	$P = Fr + 0,92 Fa$ when $Fa/Fr \leq 0,68$
		$P = 0,41 Fr + 0,87 Fa$ when $Fa/Fr > 0,68$	$P = 0,67 Fr + 0,41 Fa$ when $Fa/Fr > 0,68$
	15° Suffix C	$P = Fr$ when $Fa/Fr \leq e$	$P = Fr$ when $Fa/Fr \leq e$
		$P = 0,44 Fr + Y (1) Fa$ when $Fa/Fr > e$	$P = 0,72 Fr + Y (2) Fa$ when $Fa/Fr > e$
3200/3300 (Double row)	30°	$P = Fr + 0,73 Fa$ when $Fa/Fr \leq 0,86$	
		$P = 0,62 Fr + 1,17 Fa$ when $Fa/Fr > 0,86$	



Other dynamic & static load calculation Go to:

- Deep Groove Ball Bearings
- Self Aligning Ball Bearings
- Cylindrical Roller Bearings
- Tapered Roller Bearings
- Spherical Ball Bearings
- Thrust Ball Bearings
- Thrust Spherical Roller Bearings

#### Equivalent Load Calculation Static

Equivalent Static Load $P_o = X Fr + Y Fa$			
Series	Contact angle	Single mounting / Tandem	Back to Back / Face to Face arrangement
7200/7300 (Single row)	40° Suffix B	$P = Fr$ when $P_o \leq Fr$	$P = Fr + 0,52 Fa$
		$P = 0,5 Fr + 0,26 Fa$ when $P_o > Fr$	
	25° Suffix A	$P = Fr$ when $Fa/Fr \leq 1,3$	$P = Fr + 0,76 Fa$
		$P = 0,5 Fr + 0,38 Fa$ when $Fa/Fr > 1,3$	
	15° Suffix C	$P = Fr$ when $Fa/Fr \leq 1,09$	$P = Fr + 0,92 Fa$
		$P = 0,5 Fr + 0,46 Fa$ when $Fa/Fr > 1,09$	
3200/3300 (Double row)	30°	$P = Fr + 0,63 Fa$	

#### Thrust factors Y and e are dependant on given in tables below:

Single bearings and tandem mounted bearings:	For Back to Back & Face to Face arrangements																																																	
<p>The thrust factor Y and values of e are dependant on <math>\frac{Fa}{iCo}</math> given in tables below.</p> <p>where:</p> <p>Co = static load rating [kN] i = number of bearings</p> <table border="1"> <thead> <tr> <th><math>\frac{Fa}{iCo}</math></th> <th>e</th> <th>Y</th> </tr> </thead> <tbody> <tr><td>0.025</td><td>0.4</td><td>1.42</td></tr> <tr><td>0.04</td><td>0.42</td><td>1.36</td></tr> <tr><td>0.07</td><td>0.44</td><td>1.27</td></tr> <tr><td>0.13</td><td>0.48</td><td>1.16</td></tr> <tr><td>0.25</td><td>0.53</td><td>1.05</td></tr> <tr><td>0.50</td><td>0.56</td><td>1</td></tr> </tbody> </table>	$\frac{Fa}{iCo}$	e	Y	0.025	0.4	1.42	0.04	0.42	1.36	0.07	0.44	1.27	0.13	0.48	1.16	0.25	0.53	1.05	0.50	0.56	1	<p>The thrust factor Y and values of e are dependant on <math>\frac{Fa}{iCo}</math> given in table below.</p> <p>where:</p> <p>Co = static load rating of the single bearing kN.</p> <table border="1"> <thead> <tr> <th><math>\frac{Fa}{iCo}</math></th> <th>e</th> <th><math>Fa/Fr \leq e</math> Y</th> <th><math>Fa/Fr &gt; e</math> Y</th> </tr> </thead> <tbody> <tr><td>0.025</td><td>0.4</td><td>1.6</td><td>2.3</td></tr> <tr><td>0.04</td><td>0.42</td><td>1.5</td><td>2.2</td></tr> <tr><td>0.07</td><td>0.44</td><td>1.4</td><td>2.1</td></tr> <tr><td>0.13</td><td>0.48</td><td>1.3</td><td>1.9</td></tr> <tr><td>0.25</td><td>0.53</td><td>1.2</td><td>1.7</td></tr> <tr><td>0.50</td><td>0.56</td><td>1.1</td><td>1.6</td></tr> </tbody> </table>	$\frac{Fa}{iCo}$	e	$Fa/Fr \leq e$ Y	$Fa/Fr > e$ Y	0.025	0.4	1.6	2.3	0.04	0.42	1.5	2.2	0.07	0.44	1.4	2.1	0.13	0.48	1.3	1.9	0.25	0.53	1.2	1.7	0.50	0.56	1.1	1.6
$\frac{Fa}{iCo}$	e	Y																																																
0.025	0.4	1.42																																																
0.04	0.42	1.36																																																
0.07	0.44	1.27																																																
0.13	0.48	1.16																																																
0.25	0.53	1.05																																																
0.50	0.56	1																																																
$\frac{Fa}{iCo}$	e	$Fa/Fr \leq e$ Y	$Fa/Fr > e$ Y																																															
0.025	0.4	1.6	2.3																																															
0.04	0.42	1.5	2.2																																															
0.07	0.44	1.4	2.1																																															
0.13	0.48	1.3	1.9																																															
0.25	0.53	1.2	1.7																																															
0.50	0.56	1.1	1.6																																															



Deep Groove Ball Bearing	Self-Aligning Ball Bearing	Angular Contact Ball Bearing	Technical & Related Information
Cylindrical Roller Bearing	Tapered Roller Bearing	Spherical Roller Bearing	
Thrust Ball Bearing	Spherical Roller Thrust Bearing	Accessories Adapter & Withdrawal Sleeve	



# 9 | 0 | 0 | 3 | 4 | a

## Equivalent load calculation

### Cylindrical Roller Bearings

The equivalent dynamic radial load of a cylindrical roller bearing subjected to a pure radial load is:

$$P = Fr \text{ [kN]}$$

The equivalent static load of a cylindrical roller bearing subjected to a pure radial load is:

$$Po = Fr \text{ [kN]}$$

The axial dynamic capacity of a roller bearing having ribs on the outer or inner races (types NJ, NUP and HJ) is:

$$F_{az} = \frac{K_1 C \text{ or } 10^4}{n (d+D)} - K_2 Fr$$

where:

Faz = maximum allowable axial load [N]

Cor = static radial load [N]

Fr = radial component of loading [N]

n = speed [RPM]

d = inner diameter [mm]

D = outer diameter [mm]

K<sub>1</sub> = auxiliary factor, see table

K<sub>2</sub> = auxiliary factor, see table

Factor K<sub>1</sub> and K<sub>2</sub>

Lubrication		
Factor	grease	oil
K <sub>1</sub>	10.	6
K <sub>2</sub>	0.005	0.003



Other dynamic & static load calculation  
Go to:

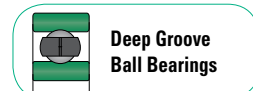

Deep Groove Ball Bearings



Self Aligning Ball Bearings



Angular Contact Ball Bearings



Tapered Roller Bearings



Spherical Ball Bearings



Thrust Ball Bearings



Thrust Spherical Roller Bearings

The permissible axial load depends on the ability of the roller ends to slide on the surface of the ribs (not fatigue values). It is therefore very important that adequate lubrication is present to assist this and dissipate heat generated by this action. The formula mentioned above is used as a guidance to calculate a suitable axial load along with the "k" factor mentioned in table 2. The formula is based on ideal conditions with (a) maximum temperature differential of up to 60°C (140°F) between ambient and bearing temperature (b) a specific heat elimination of 0.5 mW/mm<sup>2</sup> C (c) viscosity ratio k 1.5. "k" indicates an effective viscosity ratio v at working temperatures, against v1 viscosity required for a satisfactory lubrication of the bearing.

In case of grease lubrication for v ratio, the basic oil viscosity will be used. If viscosity ratio "K" is smaller than 1.5, friction and wear is generated. These can be reduced at lower speeds by use of oils with EP additives.

The thrust loads Faz obtained by the formulae are valid for constant axial loadings. For short duration the values can be doubled and may be trebled for shock loads.

For cylindrical roller bearings to function satisfactorily under thrust loads, there must also be radial loads present. The ratio of Fa/Fr should not exceed 0.4.

The axial loading of bearings has, of course, a certain influence upon their service life. This influence can be practically ignored if the Fa/Fr ratio is ≤ 0.2 in case of bearings in series 10, 2, 3, and 4, and Fa/Fr ≤ 0.4 for bearings in series 22 and 23.

In any case of thrust loads which act upon bearings, factor Fa (N) should not exceed the numerical value of 1.5 D<sup>2</sup> (D = outer diameter of the bearing in mm).

In case of certain high thrust loads (Fa ≥ D<sup>2</sup>), it is recommended to have the ribs of inner and outer rings completely supported by the integral parts of the shaft & housing.

NUP, NJ and HJ type bearings, which take thrust loads from both directions, should always be so arranged that – if the construction of the bearing permits it – main thrust loads are taken by the ribs.



Deep Groove Ball Bearing	Self-Aligning Ball Bearing	Angular Contact Ball Bearing	
Cylindrical Roller Bearing	Tapered Roller Bearing	Spherical Roller Bearing	
Thrust Ball Bearing	Spherical Roller Thrust Bearing	Accessories Adapter & Withdrawal Sleeve	Technical & Related Information



# 9 | 0 | 0 | 3 | 5 | a

## Equivalent load calculation

### Tapered Roller Bearings



Other dynamic & static load calculation  
Go to:

- Deep Groove Ball Bearings
- Self Aligning Ball Bearings
- Angular Contact Ball Bearings
- Cylindrical Roller Bearings
- Spherical Ball Bearings
- Thrust Ball Bearings
- Thrust Spherical Roller Bearings

**P = Fr**      wher     $F_a/F_r \leq e$

**P = 0.4 Fr + YFa**      wher     $F_a/F_r > e$

For paired single row tapered roller bearings:

**P = Fr + Y<sub>1</sub> Fa**      wher     $F_a/F_r \leq e$

**P = 0.67 Fr + Y<sub>2</sub> Fa**      wher     $F_a/F_r > e$

For paired bearings Fr and Fa are the loads acting on the pair.

Since the loads are transmitted from one raceway to the other in an inclined position, radial loads induce axial reaction forces which must be considered when calculating the equivalent dynamic load. For calculation purposes, the equations show where bearing A and bearing B are subjected to a radial load Fr A and Fr B, respectively, and are always considered positive even when they act in the opposite direction to that shown in the figures. The radial loads act at what is termed the "pressure center" of the bearings, which is given in the bearing tables as dimension "a". There is an external force Ka = 0; the equations are valid only if the bearings have been adjusted against each other to practically zero clearance and no preload.



Condition 1	Condition 1	Fa in A	Fa in B
$\frac{F_{rA}}{Y_A} \geq \frac{F_{rB}}{Y_B}$	$K_a \geq 0$	$F_{aA} = \frac{0.5F_{rA}}{Y_A}$	$F_{aB} = F_{aA} + K_a$
$\frac{F_{rA}}{Y_A} < \frac{F_{rB}}{Y_B}$	$K_a \geq 0.5 \left( \frac{F_{rB}}{Y_B} - \frac{F_{rA}}{Y_A} \right)$	$F_{aA} = \frac{0.5F_{rA}}{Y_A}$	$F_{aB} = F_{aA} + K_a$
$\frac{F_{rA}}{Y_A} < \frac{F_{rB}}{Y_B}$	$K_a < 0.5 \left( \frac{F_{rB}}{Y_B} - \frac{F_{rA}}{Y_A} \right)$	$F_{aA} = F_{aB} - K_a$	$F_{aB} = \frac{0.5F_{rB}}{Y_B}$



Condition 1	Condition 1	Fa in A	Fa in B
$\frac{F_{rA}}{Y_A} \leq \frac{F_{rB}}{Y_B}$	$K_a \geq 0$	$F_{aA} = F_{aB} + K_a$	$F_{aB} = \frac{0.5F_{rB}}{Y_B}$
$\frac{F_{rA}}{Y_A} > \frac{F_{rB}}{Y_B}$	$K_a \geq 0.5 \left( \frac{F_{rA}}{Y_A} - \frac{F_{rB}}{Y_B} \right)$	$F_{aA} = F_{aB} + K_a$	$F_{aB} = \frac{0.5F_{rB}}{Y_B}$
$\frac{F_{rA}}{Y_A} > \frac{F_{rB}}{Y_B}$	$K_a < 0.5 \left( \frac{F_{rA}}{Y_A} - \frac{F_{rB}}{Y_B} \right)$	$F_{aA} = \frac{0.5F_{rA}}{Y_A}$	$F_{aB} = F_{aA} - K_a$



Deep Groove Ball Bearing	Self-Aligning Ball Bearing	Angular Contact Ball Bearing	
Cylindrical Roller Bearing	Tapered Roller Bearing	Spherical Roller Bearing	
Thrust Ball Bearing	Spherical Roller Thrust Bearing	Accessories Adapter & Withdrawal Sleeve	Technical & Related Information



# 9 0 0 3 6 a

## Equivalent load calculation

### Spherical Roller Bearings

#### Equivalent Dynamic Load

$$P = Fr + Y1 Fa \quad \text{when } Fa/Fr \leq e$$

$$P = 0.67 \cdot Fr + Y2 \cdot Fa \quad \text{when } Fa/Fr > e$$

Values for Y1 , Y2 and e are given in the bearing tables.



Other dynamic & static load calculation  
Go to:



Deep Groove Ball Bearings



Self Aligning Ball Bearings



Angular Contact Ball Bearings



Cylindrical Roller Bearings



Tapered Roller Bearings



Thrust Ball Bearings



Thrust Spherical Roller Bearings

#### Equivalent Static Load

$$Po = Fr + Yo Fa$$

Values for Yo are given in the bearing tables.

#### Axial Load Capacity When Mounted On Adapter Sleeves

When spherical roller bearings are mounted on adapter sleeves fitted on smooth shafts, the axial load it will carry depends on the friction between the sleeve bore and the shaft.

The allowable axial load can be calculated by the formula

$$Faz = 3 Bd$$

Faz = maximum permissible axial load [N]

B = bearing width mm

d = bearing bore diameter mm

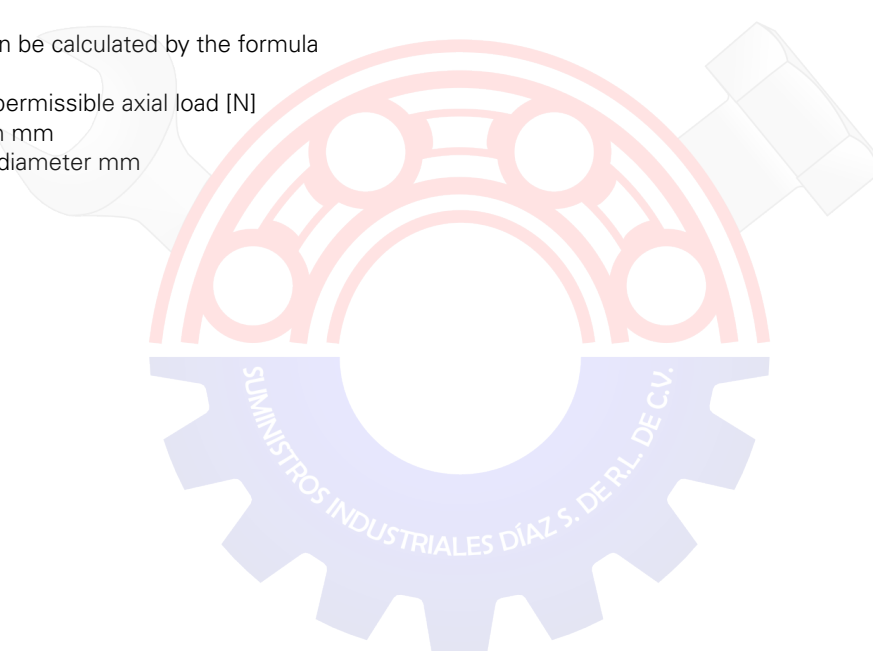



Deep Groove Ball Bearing	Self-Aligning Ball Bearing	Angular Contact Ball Bearing	
Cylindrical Roller Bearing	Tapered Roller Bearing	Spherical Roller Bearing	
Thrust Ball Bearing	Spherical Roller Thrust Bearing	Accessories Adapter & Withdrawal Sleeve	Technical & Related Information



# 9 0 0 3 7 a

## Equivalent load calculation

### Thrust Ball Bearings

Equivalent Dynamic Load

$$P = Fa$$

Where Fa is the axial load (ball thrust bearings can accommodate thrust loads only).



Other dynamic & static load calculation  
Go to:

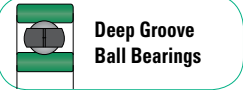

Deep Groove Ball Bearings



Self Aligning Ball Bearings



Angular Contact Ball Bearings



Cylindrical Roller Bearings



Tapered Roller Bearings



Spherical Ball Bearings



Thrust Spherical Roller Bearings

### Equivalent Static

$$Po = Fa$$

### Minimum Axial Load

Ball thrust bearings must have a minimum thrust load to function correctly.

This ensures that sliding does not occur due to centrifugal forces acting on the ball and cage assembly.

This can be calculated from:

$$F_{am} = M \left( \frac{n \text{ Max}}{1000} \right)^2 [N]$$

where:

F<sub>am</sub> = minimum thrust load [N]

M = factor for minimum load (see tables)

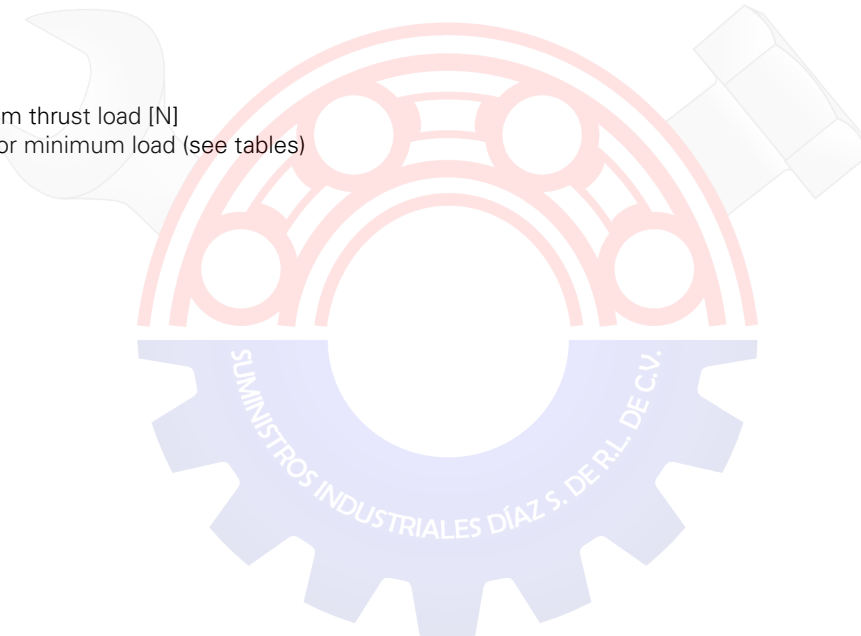





Deep Groove Ball Bearing	Self-Aligning Ball Bearing	Angular Contact Ball Bearing	
Cylindrical Roller Bearing	Tapered Roller Bearing	Spherical Roller Bearing	
Thrust Ball Bearing	Spherical Roller Thrust Bearing	Accessories Adapter & Withdrawal Sleeve	Technical & Related Information



# 9 0 0 3 8 a

## Equivalent load calculation

### Spherical Roller Thrust Bearings

#### Equivalent Dynamic Load

$$P = Fa + 1.2 Fr \quad \text{Providing } Fr \leq 0.55 Fa$$

#### Equivalent Static Load

$$Po = Fa + 2.7 Fr \quad \text{Providing } Fr \leq 0.55 Fa$$

#### Minimum Axial Load

This can be calculated from:

$$Fam = \frac{1.25 Co}{1000} [kN]$$

where:

- Fam = minimum axial load [kN]
- Fr = radial component of load for bearings subjected to combined load [kN]
- Co = basic static load [kN]

In many cases, the axial load acting on the bearing produced by the weight of the supporting component parts and external forces is greater than the required minimum load. If this is not the case, then bearings must be preloaded (for example, using springs).



Other dynamic & static load calculation  
Go to:

- Deep Groove Ball Bearings
- Self Aligning Ball Bearings
- Angular Contact Ball Bearings
- Cylindrical Roller Bearings
- Tapered Roller Bearings
- Spherical Ball Bearings
- Thrust Ball Bearings





Deep Groove Ball Bearing	Self-Aligning Ball Bearing	Angular Contact Ball Bearing	Technical & Related Information
Cylindrical Roller Bearing	Tapered Roller Bearing	Spherical Roller Bearing	
Thrust Ball Bearing	Spherical Roller Thrust Bearing	Accessories Adapter & Withdrawal Sleeve	

## 90040a

### Limited speed

The maximum rotational speed of ball and roller bearings depends upon various factors: the size and design of the bearing, type of lubrication (whether grease or oil), and type of cage fitted, along with the internal clearance of the bearing when mounted. If the radial run-out (which produces out of balance forces) is reduced, then higher speeds can be obtained. Reduction of cage weight will also reduce out of balance forces, such as when made from light alloy or plastic. Cages that are centered on the inner or outer races rather than the rolling elements are used for high speed applications. With the surface of the riding lips having been specially ground, lubrication between the sliding surfaces must be maintained. Heavier loads influence the speed and also affect the basic rating life of  $L_{10h} \leq 75000$  hours.

In such cases, the speeds listed in the tables should be multiplied by a factor  $f$  which you can obtain from the diagram below.

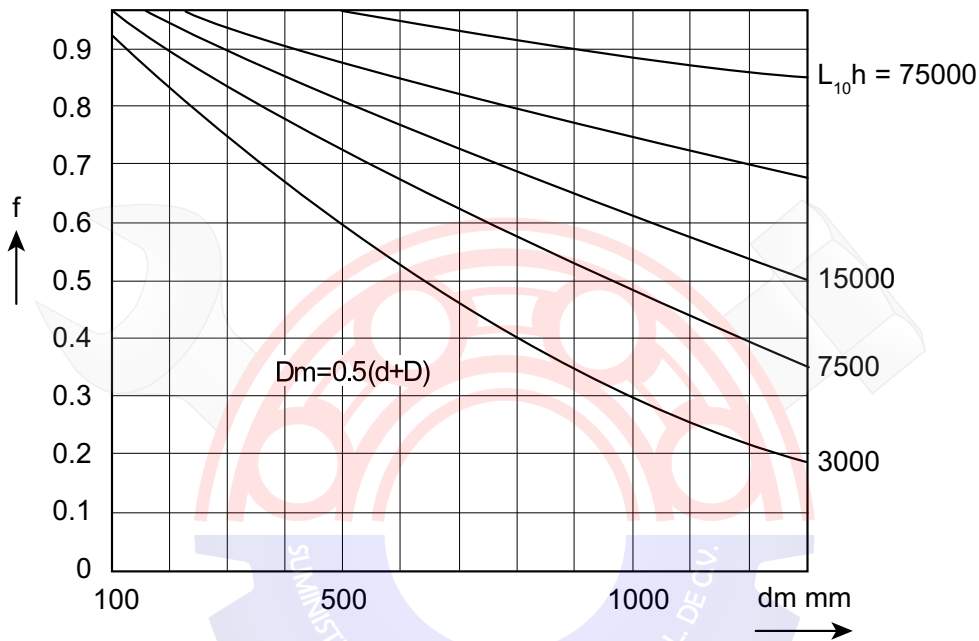

For combined loads, the speeds indicated in the bearing tables are to be multiplied by the reduction factor  $f_1$  given in diagram below.

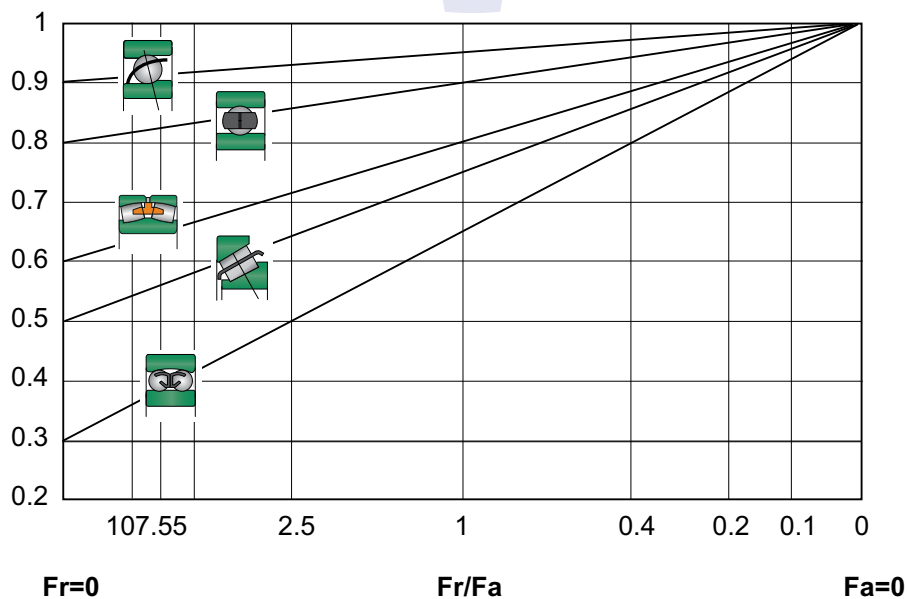

For ball thrust bearings, there must be a minimum load applied to counteract the centrifugal forces of the balls on rotation. Factor  $M$  is indicated in the bearing tables against the appropriate bearing size.



Deep Groove Ball Bearing	Self-Aligning Ball Bearing	Angular Contact Ball Bearing	
Cylindrical Roller Bearing	Tapered Roller Bearing	Spherical Roller Bearing	
Thrust Ball Bearing	Spherical Roller Thrust Bearing	Accessories Adapter & Withdrawal Sleeve	Technical & Related Information

# 9 0 0 5 0 a

## Materials used in the manufacturing of roller bearings

Bearing rings and rolling elements are subjected to high stresses on a very small contact area, and must have a high resistance to wear as well as high elastic and fatigue limits. Primarily these are manufactured from high-carbon chromium bearing steel with a chemical composition as indicated in table below, and are in accordance with SAE 52100 - 100Cr6.

### High carbon chromium bearing steel

Steel Grade		Chemical Composition %					
		C	Mn	Si	Cr	S	P
ROL1	100 Cr6	0.90..1.05	0.25..0.40	0.15..0.35	1.40..1.65	<0.025	<0.025
	100 CrMnSi6-4	0.90..1.05	1.00..1.20	0.50..0.70	1.40..1.60	0.020	<0.025
ROL2 (GMEX)		0.94~1.04	0.25~0.45	0.15~0.35	1.40~1.60	≤0.012	≤0.020

For large bearings that are subjected to high shock loads, carburized low carbon alloy steels are used. Such steels, when carburized to the correct depth, have the added advantage of having a hard surface - and because the core is softer, it is more energy absorbing.

### CAGE MATERIALS

Types of cages for bearings vary in accordance with the operating conditions. The most common are those made from pressed steel. Machined cages are made from high strength copper alloys or carbon steel, and for high speeds manufactured from plastic or phenolic resins.

### HEAT TREATMENT

Bearings are generally used up to a temperature of maximum + 150°C (+302°F). In case of higher temperatures, bearings with special heat treatments should be used. Sealed bearings, 2RS type, should be used at operating temperatures up to +80°C (+176°F). If this temperature is exceeded, the efficacy of lubricants is considerably reduced.

In order to use bearings at a higher operating temperature, the bearings have to be subjected to a special heat treatment. This will ensure the dimensional stability, but will reduce the lifetime by a factor (ft) as per the table below.

Operating temp °C	150	200	250	300
Working temperature °F	302	392	482	572
Symbol	S0	S1	S2	S3
ft	1	0.73	0.42	0.22



Deep Groove Ball Bearing	Self-Aligning Ball Bearing	Angular Contact Ball Bearing	
Cylindrical Roller Bearing	Tapered Roller Bearing	Spherical Roller Bearing	
Thrust Ball Bearing	Spherical Roller Thrust Bearing	Accessories Adapter & Withdrawal Sleeve	Technical & Related Information

# 9 0 0 6 0 a

## Suffixes and prefixes supplementary designation

### Prefixes

- S - Stainless steel components
- K - Cylindrical roller and cage thrust assembly
- L - Removable inner or outer ring
- R - Removable bearing with no inner ring
- F - Shaft washer of thrust ball bearing
- W - Housing washer of thrust ball bearing
- WS - Shaft washer of thrust roller bearing
- GS - Housing washer of thrust roller bearing

### Suffixes

Modifications to internal design of bearings.

#### Deep Groove Ball Bearings

- EMQ - Electric motor quality

#### Single Row Angular Contact Ball Bearings

- A - Contact angle of 25°
- B - Contact angle of 40°
- C - Contact angle of 15°

#### Tapered Roller Bearings

- A - Increased load capacity

#### Cylindrical Roller Bearings

- E - Increased load capacity
- NA - Non-interchangeable components
- M - Brass cage guided on the rollers
- EM - Increased load capacity and brass cage guided on the rollers
- EMA - Increased load capacity and brass cage guided on the outer ring

#### Spherical Roller Thrust Bearing

- EM - Increased load capacity and new brass cage

#### Spherical Roller Bearings

- C - Pressed steel cage and loose guide ring
- CA - one piece brass cage, guided on the rollers. Assymetrical roller position
- GMEX - Improved precision, roundness and surface finish, rings and rollers are manufactured in high grade ROL2 steel, one piece robust brass cage, guided on the rollers.
- MB - 2 piece brass cage , guided on the inner ring
- VS C4 F80 - Special bearing for vibration screen application, d<320
- MA C4 F80 - Special bearing for vibration screen application, d>320

#### Modifications to external design of bearings

- X - Boundary dimensions altered according to ISO
- K - Bearings with tapered bore 1:12
- K30 - Bearings with tapered bore 1:30
- R - Flange on outer ring of bearing
- N - Snap ring groove on outer ring of bearing
- NR - Snap ring groove with snap ring
- N2 - Diametrically opposed notches on outer ring corner
- RS - Seal on one side of bearing
- 2RS - Seals on both sides of bearing
- Z - Shield on one side of bearing
- ZZ - Shields on both sides of bearing
- TM - Polyamide cage



Deep Groove Ball Bearing	Self-Aligning Ball Bearing	Angular Contact Ball Bearing	
Cylindrical Roller Bearing	Tapered Roller Bearing	Spherical Roller Bearing	
Thrust Ball Bearing	Spherical Roller Thrust Bearing	Accessories Adapter & Withdrawal Sleeve	Technical & Related Information



# 90070a

## Lubrication

### General guidelines, rolling bearing lubrication

Grease & Oil  
lubrication

Systems oil  
lubrication

#### General Guidelines

The main duties of introducing lubricants into ball and roller bearings, apart from protecting the finely finished surfaces when rotating at high speeds, is to reduce friction between the rolling elements, the separator or cage, and the races at any point where true rolling is absent. Lubrication also assists in dissipating heat, and sealing the bearing against the entry of contaminants such as dust and moisture.

Rolling bearings may be lubricated with oil or grease. The choice of lubricant is usually decided by temperature, speed, load, and operating conditions along with bearing design. We summarise as follows:

#### Size of bearing

The size of bearing governs the viscosity of the lubricant – the larger the bearing the higher should be the viscosity. Regarding size, rolling bearings can be divided into four sizes depending on the outside diameter:

Very small bearings	$D \leq 22 \text{ mm}$
Small bearings	$D \leq 62 \text{ mm}$
Medium bearings	$62 \leq D \leq 240 \text{ mm}$
Large bearings	$D \geq 240 \text{ mm}$

#### 1. Speed

Speed has an influence upon the viscosity of the lubricant because the resisting force, opposed to the moving parts by the lubricant, depends on its viscosity. The higher the revolution speed, the lower the viscosity of the lubricant should be.

The revolution speed may be:

Normal  $n \leq 75\%$  of the limit speed specified in the tables

High  $75\% \leq 100\%$  of the limit speed specified in the tables

Very high  $n \geq 100\%$  of the limit speed specified in the tables. For very high revolution speeds, oil lubrication is required to transfer frictional heat or other sources of heat away from the bearing.

#### 2. Load

Equivalent loading capacity,  $P = XFr + YFa$ , conditions the viscosity grade of the lubricant, due to specific pressure which appears between the contact surfaces. The higher this is, the greater the resistance of the lubricant film should be, and the respective viscosity.

Loads may vary as follows:

normal loads where

$P/Cr \leq 0.1$  for bearings within diameter ranges 1, 2 and 3.

$P/Cr \leq 0.15$  for bearings within diameter range 4.

high loads where

$P/Cr \geq 0.1$  for bearings within diameter ranges 1, 2 and 3.

$P/Cr \geq 0.15$  for bearings within diameter range 4.

$P$  = equivalent dynamic load [kN]

$Cr$  = basic dynamic load [kN]

#### 3. Temperature

The operating temperature affects selection of lubricants, as it is an influence upon viscosity. Therefore, each lubricant is used only within the limits of certain clearly defined temperature ranges.



Deep Groove Ball Bearing	Self-Aligning Ball Bearing	Angular Contact Ball Bearing	Technical & Related Information
Cylindrical Roller Bearing	Tapered Roller Bearing	Spherical Roller Bearing	
Thrust Ball Bearing	Spherical Roller Thrust Bearing	Accessories Adapter & Withdrawal Sleeve	

# 9 | 0 | 0 | 7 | 0 | c

## Lubrication

### Grease & oil lubrication

General Guidelines

Systems oil lubrication

### Grease Lubrication

Although oil is the better lubricant, grease is often preferred because of the following natural advantages:

Grease helps to form an effective closure between the shaft and housing, thus preventing the ingress of dirt, moisture and other corrosive agents.

Grease protects the finely finished working surfaces of a bearing by clinging to them, particularly when the bearing is not in motion. Oil tends to drain away, leaving the surfaces open to attack.

Grease is easier to retain within the housing than oil. This is of great help in the food, printing, textile, chemical and other industries where contamination or staining can ruin the product.

Grease is convenient to handle, and re-lubrication of bearings is quick and clean. Planned lubrication cycles are often possible, resulting in smaller labour costs.

Whatever type of grease is used, it should have no tendency to separate under operating conditions. When separation occurs, the oil runs out of the bearing and leaves behind dry soap, which hardens and cakes. This interferes with the movement of the rolling element, which may result in overheating and mechanical failure. Excessive softening is also undesirable, because the grease might then leak out of the bearing and leave working surfaces unprotected.

The quantity of grease used for the lubrication of a rolling bearing should not be too great, as a tightly packed bearing is liable to overheat if operated at high speed. Relubrication intervals depend on the bearing type, inner diameter and revolution speed for filling with fresh grease. The quantity required is given in the following equation:

$$G = 0.005 \text{ DB grams}$$

where:

D = outer diameter (m/m)

B = width (m/m)

After a certain number of refills, it is necessary to remove old grease completely using a suitable solvent. Never mix two grades of grease.

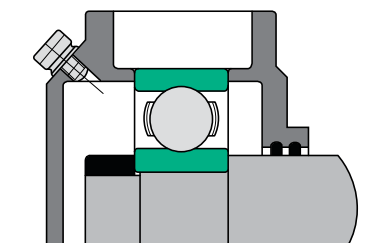

Typical Grease Lubrication

### Oil Lubrication

Oil is sometimes more convenient to use than grease, and there are circumstances when it is definitely preferred. These are as follows:

When frictional resistance in light machinery and instruments must be kept low.

Where either the speed or the temperature is too high for grease lubrication.

Where high temperature and heavy load occur together, with or without high speed.

Where the bearings are enclosed in a casing that contains other components lubricated by oil, e.g. a gearbox.

A good quality mineral oil should be used of a viscosity to suit the operating conditions involved. Vegetable or animal oils are not recommended as these can become rancid under certain conditions and cause corrosion problems. A small supply of oil is required to lubricate the bearings; a more copious supply should be used if the bearing must be kept cool, when it is often advantageous to use a synthetic oil to cope with the temperature conditions. Limiting temperature for mineral oil is about 150°C (302°F) and for synthetic oils about 220°C (428°F).



Deep Groove Ball Bearing	Self-Aligning Ball Bearing	Angular Contact Ball Bearing	Technical & Related Information
Cylindrical Roller Bearing	Tapered Roller Bearing	Spherical Roller Bearing	
Thrust Ball Bearing	Spherical Roller Thrust Bearing	Accessories Adapter & Withdrawal Sleeve	



# 9 | 0 | 0 | 7 | 0 | e

## Lubrication

### System of oil lubrication

**General Guidelines**

**Grease & Oil lubrication**

### Oil Bath

This method is suitable for horizontal shaft applications. The oil should reach the center of the bottom ball or roller in the bearing; a greater depth than this could cause overheating due to churning of the oil. The surface area and volume of the oil in the bath should be sufficiently large to maintain an adequate depth of oil for the cage to dip into when running. Sight oil level indicators can be used. Alternatively, a tapped and plugged hole can be provided at the correct level; when replenishing the oil, the plug is removed and oil added until it starts to escape through the hole. The plug should, of course, be replaced before the machine is started!

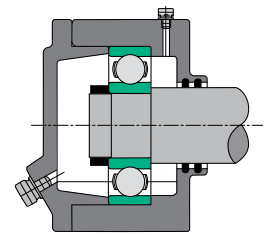

### Pump-Feed Lubrication

This is especially suitable for heavily loaded, high-speed bearings, since such conditions can result in bearing temperatures well in excess of 100°C (212°F). Oil is pump-fed to each bearing, being directed by jets on to the outside diameter of the inner ring so that some of it gains access to the internal parts of the bearing. Each bearing may require from 45 to 140 litres of oil per hour, although most of this only flushes the face of the bearing to keep it cool. A reservoir is often provided to lubricate the bearing during starting: alternatively, the pump can be started before the machine is set in motion so that the bearing never runs unlubricated.

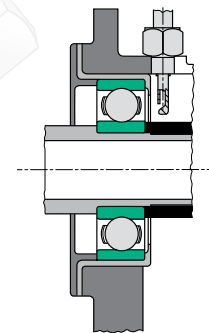

### Splash Lubrication

This is suitable when the bearings are enclosed in a casing, such as a gearbox, and the oil used to lubricate the gears is distributed sufficiently to lubricate the bearings. The oil is either splashed directly on to the bearings or collected in galleries and directed to the bearings. The drawing below illustrates how the oil is made to pass through the bearing before it returns to the gearbox casing.

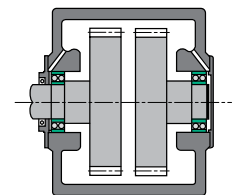

### Oil Mist System

One important advantage of this method of lubrication is that only a small quantity of oil is required, carried in a stream of compressed air. The oil mist equipment should be turned on before the machine is set in motion so as to ensure that the bearings are constantly covered by a thin film of oil when rotating.

Oil mist is advantageous for applications such as machine tools (where it can also be used to lubricate slideways, gears, chains and other components), since the air escaping from the bearing housing prevents the ingress of foreign matter. The flow of air also keeps the bearing cool. It is important that the compressed air used is absolutely clean and dry.

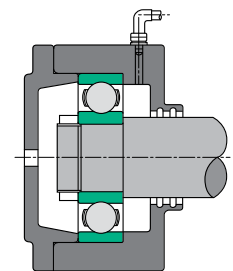



Deep Groove Ball Bearing	Self-Aligning Ball Bearing	Angular Contact Ball Bearing	
Cylindrical Roller Bearing	Tapered Roller Bearing	Spherical Roller Bearing	
Thrust Ball Bearing	Spherical Roller Thrust Bearing	Accessories Adapter & Withdrawal Sleeve	Technical & Related Information



# 9 | 0 | 0 | 8 | 0 | a

## Handling of bearings

### Care & fitting of bearings

continue

#### Storage

1. Store ball and roller bearings in a clean, dry place in their original wrappings. This will preserve them from deterioration.
2. Use older stock first.
3. Do not stack too many large bearings on top of each other. This can cause the protective oil to be squeezed out from between the bearing and its wrapping, thus leading to corrosion problems. Also, never store large bearings upright, but lay them flat.

#### Fitting

4. Absolute cleanliness is essential when handling bearings. They should not be removed from their wrappings until required for fitting. A smooth, metal-topped bench that can be wiped clean is a great advantage. All tools, shafts, housings and other components must be perfectly clean. If fitting operations are delayed or interrupted, the assembly should be wrapped with greaseproof paper to exclude dirt and dust.
5. Bearings are usually coated with a rust-preventative oil, unless pre-lubricated and/or packed to suit individual requirements. There is no need to remove this oil unless:
  - It is sufficient to cause serious dilution of the oil or grease used in the bearing. This normally applies to smaller bearings where the rust - preventative oil represents a large proportion of the required amount of lubricant.
  - Low torque is required.
  - A synthetic lubricant is used that may not be compatible with the protecting oil.

To remove the rust preventive oil, wash the bearing in a good quality cleaning fluid. Allow the bearings to drain thoroughly and dry them. The following are satisfactory methods for drying:

  - Place the bearing in an oven or on a hot plate with a temperature of 65-80°C (149-176°F).
  - Direct dry, clean, compressed air on to the bearings. The cage and rings of smaller bearings must be held firmly. A sudden blast of air can rapidly accelerate the free bearing parts, causing the balls to skid and damaging the highly finished internal surfaces of the bearing. The fitting of the rings on their seatings are very important. Therefore, ensure that the shaft and housing seatings are of correct size and of good shape.
6. All shoulders must be smooth and square with the axis of rotation.
7. Never drive one ring on to its seating by blows on the other. Such blows cause damage to the balls or rollers and raceways.
8. Apply pressure evenly around the rings. A press is better than a hammer.
9. Should a hammer be used, a mild steel or brass tube of suitable size should be interposed between it and the bearing. This will distribute the force of the taps, which should be given progressively around the ring.
10. When the inner ring, outer ring and rollers of a separable roller bearing are brought together, they must be properly in alignment with each other. When not aligned, the rollers are unable to slide freely, and force would need to be used to bring the parts together. Such force would result in the rollers and raceways becoming scored. This, in addition to causing noisy running, can cause early failure of the bearing.
11. Where the ring of a bearing is to be against an abutment, make sure it is properly seated.
12. For heavy interference fits, inner rings may be shrunk onto their seatings after heating in clean mineral oil at a temperature of approximately 100%. Confirm that the bearing is in contact with the abutment shoulder after it has cooled.
13. In the case of taper clamping sleeve and nut bearings, the clamping nut must not be over-tightened. This can expand the inner ring and eliminate all clearance within the bearing, or even fracture the inner ring.

It is recommended that when using pin spanners, they have a length of approximately five times the shaft diameter. After the nut has been tightened as much as possible by hand pressure, one or two light hammer blows should be given to the handle of the spanner; this should tighten the nut sufficiently. It is good practice, if possible, to check that the sleeve is still clamped firmly to the shaft after a few days running.

As an additional precaution it is recommended that, whenever possible, the bearings are fitted so that the rotation of the shaft tends to tighten the nut on the sleeve.

When using torque spanners, it is recommended that the following torques be applied to the clamping nut:

For LIGHT series bearings:

Shaft Diameter	Torque on Nut
1" and 25m/m	7.6 Kgm/M (55 lbs ft)
1 1/2" and 40 m/m	12.4 Kgm/M (90 lbs ft)
2" and 50 m/m	17.25 Kgm/M (125 lbs ft)
3" and 75 m/m	30.3 Kgm/m (220 lbs ft)

For MEDIUM series bearings, increase the above figures by approximately 50 percent.





Deep Groove Ball Bearing	Self-Aligning Ball Bearing	Angular Contact Ball Bearing	
Cylindrical Roller Bearing	Tapered Roller Bearing	Spherical Roller Bearing	
Thrust Ball Bearing	Spherical Roller Thrust Bearing	Accessories Adapter & Withdrawal Sleeve	Technical & Related Information



## 9 | 0 | 0 | 8 | 0 | c

## Handling of bearings

### Dismantling and replacement

[back](#)

14. Unnecessary removal of a bearing should be avoided, particularly where interference fits have been used. Removal can damage a bearing and, in some instances, cause deterioration of the interference fit. Very often it is sufficient to clean and relubricate the bearing in its fitted position.

Only remove a bearing if you need to inspect it closely. Symptoms that may require close inspection are the condition of the lubricant, the bearing temperature and noise level.

15. Sometimes a ball locating bearing is installed with roller journal bearings. This may be only push fit on the shaft, and therefore easily dismantled.

16. In certain applications, some form of extractor may be necessary. This must act directly on the ring to be removed. Never try to remove the inner ring by applying force to the outer ring, or vice versa.

17. Thrust bearings are usually installed with push fits, and should offer no difficulty. Take care to keep the rings aligned, however, to prevent them from binding.

18. Carefully protect bearings from dirt and moisture while they are out of their housings. It is advisable to wash them thoroughly immediately after removal, using the following procedure:

- Immerse in a washing fluid, such as clean white spirit or good-quality paraffin. The washing fluid must not attack the bearing components. After soaking, move each separate bearing around in the fluid, using a basket or other container if convenient. Occasional slow oscillations of the bearing rings will help to dislodge dried out grease and other matter.

- When clean, thoroughly drain and dry.

- Lubricate the bearing immediately and re-fit. Alternatively, completely coat all parts with a rust preventative oil, working it well into the internal parts of the bearing. Then wrap the bearing in greasproof paper and box until required for re-fitting, when the bearing will require re-lubricating.

19. Worn shafts, housings and abutments must have attention if creep has occurred. Do not resort to knurling, scoring, or distortion of the seating on which creep has occurred in order to simulate an interference fit. Such deceptive practices are ineffective, and creep will quickly return. In addition, even if the ring is prevented from creeping it will usually be distorted by the seating, resulting in bearing failure due to local overloading of the raceways and of the balls or rollers.

20. Worn shafts, housings and abutments must have attention if creep has occurred. Do not resort to knurling, scoring, or distortion of the seating on which creep has occurred in order to simulate an interference fit. Such deceptive practices are ineffective, and creep will quickly return. In addition, even if the ring is prevented from creeping it will usually be distorted by the seating, resulting in bearing failure due to local overloading of the raceways and of the balls or rollers.



Deep Groove Ball Bearing	Self-Aligning Ball Bearing	Angular Contact Ball Bearing	Technical & Related Information
Cylindrical Roller Bearing	Tapered Roller Bearing	Spherical Roller Bearing	
Thrust Ball Bearing	Spherical Roller Thrust Bearing	Accessories Adapter & Withdrawal Sleeve	



# 90090a

## Internal clearances

### Introduction

#### Radial clearance

Radial clearance is the total internal clearance between the balls or rollers in a bearing and their raceways, measured normal to the axis of the bearing. This clearance compensates for: expansion of the inner ring and/or contraction of the outer ring when interference fits are used for differential expansion of the two rings when the inner ring of a bearing operates at a higher temperature than the outer ring affects the end play of ball bearings and also affects their capacity for carrying axial loads – the greater the radial clearance, the greater the capacity for supporting axial load. When bearings with small radial clearances are used, special attention must be given to the selection of seating dimensions. Once ball and roller bearings are mounted and running, a small amount of radial or running clearance is normally desirable. In the case of bearings under radial load, quieter running is generally obtained when this clearance is at minimum. Radial clearance figures for ball and roller bearings mentioned in our tables are in accordance with I.S.O. recommendations. For normal applications, the general guide given in Table 1 below may be used. Excessive radial tightness in the bearing should be avoided under all conditions.

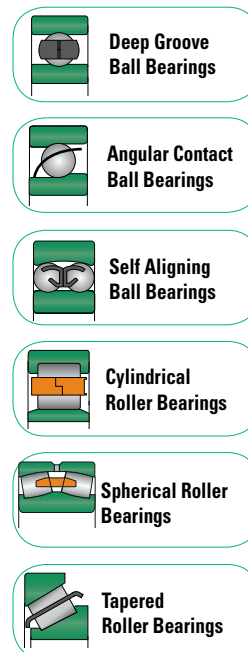

Table 1 – Summarizing The Correct Radial Clearance

Radial clearance of bearing	Fit of races on seating	Possibility of temperature changes reducing radial clearance
C2	No appreciable interference either race	absent
CN	One race only interference fit	absent
C3	One race only interference fit	present
C3	Both races interference fit	absent
C4	Both races interference fit	present

- C2 fit** These bearings have the smallest amounts of radial clearance. They should only be used where freedom from all play is required in the assembled bearing, and there is no possibility of the initial radial clearances being eliminated by external causes. Therefore, special attention must be given to the seating dimensions, as the expansion of the inner ring or contraction of the outer ring may cause tight bearings.
- CN fit** This grade of radial clearance is intended for use where only one ring is made interference fit, and there is no appreciable loss of clearance due to temperature differences. Ball and roller bearings for general engineering applications are usually of this clearance.
- C3 fit** This grade of radial clearance should be used when both rings of a bearing are made an interference fit, or when only one ring is an interference fit but there is likely to be some loss of clearance due to temperature differences. It is the grade normally employed for roller journal bearings on general engineering applications, especially where there is a tendency for "creep" to take place due to out-of-balance loading. It is also the grade normally used for ball bearings that take axial loading, but for some purposes even "C4" fit bearings may be required.
- C4 fit** This is the grade of radial clearance to adopt when there will be some loss of clearance due to temperature differences and both races must be an interference fit. One example of its use is in bearings for traction motors.

Where seating limits give an interference fit tighter than the recommended figures, or where temperature differences could cause radial tightness, the correct clearance can be established by calculating the maximum loss of clearance at both extremes of the following basis. A suitable clearance grade from the tables can then be selected.

Total lost of clearance = RI + RO + RT + RM

- RI = Expansion of inner ring raceway due to shaft interference. (See table below).
- RO = Contraction of outer ring raceway due to housing interference. (See table below).
- RT = Loss of clearance due to the inner ring being at a higher temperature than the outer ring.
- RM = Loss of clearance due to increase in seating interference, resulting from nonferrous seating expanding or contracting at different rates from bearing steel.

Table 2 below gives approximate values for RO and RI assuming a solid shaft and substantial housing.

Bearing series	Inner ring raceway expansion RI	Outer ring raceway Contraction RO
Extra light	100% interference	80% interference
Light	80% interference	60% interference
Medium and heavy	70% interference	50% interference



Deep Groove Ball Bearing	Self-Aligning Ball Bearing	Angular Contact Ball Bearing	
Cylindrical Roller Bearing	Tapered Roller Bearing	Spherical Roller Bearing	
Thrust Ball Bearing	Spherical Roller Thrust Bearing	Accessories Adapter & Withdrawal Sleeve	Technical & Related Information



# 90090c

## Fits and internal clearances

### Single Row & Double Row Deep Groove Ball Bearings

With Cylindrical Bore - Clearance to ISO 5753-2009

Radial clearance

Normal bore diameter d mm		Symbol of clearance group									
		C2		CN		C3		C4		C5	
		Radial clearance of bearing μm									
over	up to	min.	max.	min.	max.	min.	max.	min.	max.	min.	max.
2,5	10	0	7	2	13	8	23	14	29	20	37
10	18	0	9	3	18	11	25	18	33	25	45
18	24	0	10	5	20	13	28	20	36	28	48
24	30	1	11	5	20	13	28	23	41	30	53
30	40	1	11	6	20	15	33	28	46	40	64
40	50	1	11	6	23	18	36	30	51	45	73
50	65	1	15	10	30	25	43	38	61	55	90
65	80	1	15	8	28	23	51	46	71	65	105
80	100	1	18	12	36	30	58	53	84	75	120
100	120	2	20	15	41	36	66	61	97	90	140
120	140	2	23	18	48	41	81	71	114	105	160
140	160	2	23	18	53	46	91	81	130	120	180
160	180	2	25	20	61	53	102	91	147	135	200
180	200	2	30	25	71	63	117	107	163	150	230
200	225	2	35	25	85	75	140	125	195	175	265
225	250	2	40	30	95	85	160	145	225	205	300
250	280	2	45	35	105	90	170	155	245	225	340
280	315	2	55	40	115	100	190	175	270	245	370
315	355	3	60	45	125	110	210	195	300	275	410
355	400	3	70	55	145	130	240	225	340	315	460
400	450	3	80	60	170	150	270	250	380	350	510
450	500	3	90	70	190	170	300	280	420	390	570
500	560	10	100	80	210	190	333	310	470	440	630
560	630	10	110	90	230	210	360	340	520	490	690
630	710	20	130	110	260	240	400	380	570	540	780
710	800	20	140	120	290	270	450	430	630	600	840
800	900	20	160	140	320	300	500	480	700	670	940
900	1000	20	170	150	350	330	550	530	770	740	1040
1000	1120	20	180	160	380	360	600	580	850	820	1150
1120	1250	20	190	170	410	390	650	630	920	890	1260
1250	1400	30	220	200	450	430	710	680	1100	980	1380



Fits and internal clearances index

Other fits & internal clearances Go to:

Self Aligning Ball Bearings

Angular Contact Ball Bearings

Cylindrical Roller Bearings

Tapered Roller Bearings

Spherical Roller Bearings

With Tapered Bore - Clearance to ISO 5753-2009

Radial clearance

Normal bore diameter d mm		Symbol of clearance group							
		C2		CN		C3		C4	
		Radial clearance of bearing μm							
over	up to	min.	max.	min.	max.	min.	max.	min.	max.
2,5	10	2	13	8	23	14	29	20	37
10	18	3	18	11	25	18	33	25	45
18	24	5	20	13	28	20	36	28	48
24	30	5	20	13	28	23	41	30	53
30	40	6	20	15	33	28	46	40	64
40	50	6	23	18	36	30	51	45	73
50	65	8	28	23	43	38	61	55	90
65	80	10	30	25	51	46	71	65	105
80	100	12	36	30	58	53	84	75	120
100	120	15	41	36	66	61	97	90	140
120	140	18	48	41	81	71	114	105	160
140	160	18	53	46	91	81	130	120	180
160	180	20	61	53	102	91	147	135	200
180	200	25	71	63	117	107	163	150	230
200	225	25	85	75	140	125	195	175	265
225	250	30	95	85	160	145	225	205	300
250	280	35	105	90	170	155	245	225	340
280	315	40	115	100	190	175	270	245	370
315	355	45	125	110	210	195	300	275	410
355	400	55	145	130	240	225	340	315	460
400	450	60	170	150	270	250	380	350	510
450	500	70	190	170	300	280	420	390	570
500	560	80	210	190	333	310	470	440	630
560	630	90	230	210	360	340	520	490	690
630	710	110	260	240	400	380	570	540	780
710	800	120	290	270	450	430	630	600	840
800	900	140	320	300	500	480	700	670	940
900	1000	150	350	330	550	530	770	740	1040
1000	1120	160	380	360	600	580	850	820	1150
1120	1250	170	410	390	650	630	920	890	1260
1250	1400	200	450	430	710	680	1100	980	1380



Deep Groove Ball Bearing	Self-Aligning Ball Bearing	Angular Contact Ball Bearing	Technical & Related Information
Cylindrical Roller Bearing	Tapered Roller Bearing	Spherical Roller Bearing	
Thrust Ball Bearing	Spherical Roller Thrust Bearing	Accessories Adapter & Withdrawal Sleeve	

# 90090e

## Fits and internal clearances

### Single & Double Row Angular Contact Ball Bearings

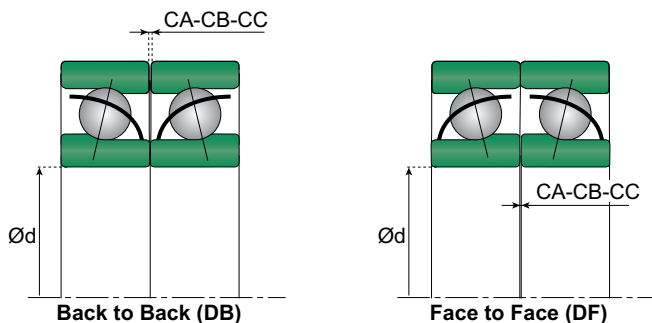

Fits and internal clearances index

**Axial clearance** Single row angular contact ball bearings arranged in "DB" and "DF" pairs

Normal bore diameter d		Series 32 and 33					
		Class					
mm		CA	CB		CC		
		Axial clearance of bearing µm					
over	up to	min.	max.	min.	max.	min.	max.
-	18	5	13	15	23	24	32
18	30	7	15	18	26	32	40
30	50	9	17	22	30	40	48
50	80	11	23	26	38	48	60
80	120	14	26	32	44	55	67
120	180	17	29	35	47	62	74
180	250	21	37	45	61	74	90
250	315	26	42	52	68	90	106

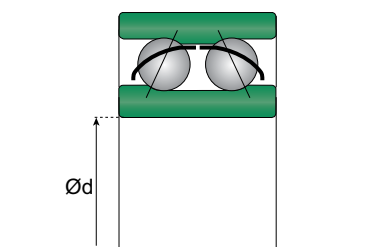

Other fits & internal clearances Go to:

- Deep Groove Ball Bearings
- Self Aligning Ball Bearings
- Cylindrical Roller Bearings
- Tapered Roller Bearings
- Spherical Roller Bearings

**Axial Clearance** Double Row Angular Contact Ball Bearings

Normal bore diameter d		Series 32 and 33						Series 33D normal	
		C2		CN		C3			
mm		Axial clearance of bearing µm							
over	up to	min.	max.	min.	max.	min.	max.	min.	max.
-	10	1	11	5	21	12	28	-	-
10	18	1	12	6	23	13	31	-	-
18	24	2	14	7	25	16	34	-	-
24	30	2	15	8	27	18	37	-	-
30	40	2	16	9	29	21	40	33	54
40	50	2	18	11	33	23	44	36	58
50	65	3	22	13	36	26	48	40	63
65	80	3	24	15	40	30	54	46	71
80	100	3	26	18	46	35	63	55	83
100	110	4	30	22	53	42	73	65	96

Radial clearance ≈ 0,6 axial clearance



Deep Groove Ball Bearing	Self-Aligning Ball Bearing	Angular Contact Ball Bearing	Technical & Related Information
Cylindrical Roller Bearing	Tapered Roller Bearing	Spherical Roller Bearing	
Thrust Ball Bearing	Spherical Roller Thrust Bearing	Accessories Adapter & Withdrawal Sleeve	



# 9 | 0 | 0 | 9 | 0 | h

## Fits and internal clearances

### Double Row Self Aligning Ball Bearings

With cylindrical bore - Clearance to ISO 5753-2009

Radial Clearance

Normal bore diameter d		Symbol of clearance group							
		C2		CN		C3		C4	
mm		Radial clearance of bearing μm							
over	up to	min.	max.	min.	max.	min.	max.	min.	max.
2,5	6	1	8	5	15	10	20	15	25
6	10	2	9	6	17	12	25	19	33
10	14	2	10	6	19	13	26	21	35
14	18	3	12	8	21	15	28	23	37
18	24	4	14	10	23	17	30	25	39
24	30	5	16	11	24	19	35	29	46
30	40	6	18	13	29	23	40	34	53
40	50	6	19	14	31	25	44	37	57
50	65	7	21	16	36	30	50	45	69
65	80	8	24	18	40	35	60	54	83
80	100	9	27	22	48	42	70	64	96
100	120	10	31	25	56	50	83	75	114
120	140	10	38	30	68	60	100	90	135
140	160	15	44	35	80	70	120	110	161



Fits and internal clearances index

Other fits & internal clearances Go to:

Deep Groove Ball Bearings

Angular Contact Ball Bearings

Cylindrical Roller Bearings

Tapered Roller Bearings

Spherical Roller Bearings

With tapered bore - Clearance to ISO 5753-2009

Radial Clearance

Normal bore diameter d		Symbol of clearance group							
		C2		CN		C3		C4	
mm		Radial clearance of bearing μm							
over	up to	min.	max.	min.	max.	min.	max.	min.	max.
18	24	7	17	13	26	20	33	28	42
24	30	9	20	15	28	23	39	33	50
30	40	12	24	19	35	29	46	40	59
40	50	14	27	22	39	33	52	45	65
50	65	18	32	27	47	41	61	56	80
65	80	23	39	35	57	50	75	69	98
80	100	29	47	42	68	62	90	84	116
100	120	35	56	50	81	75	108	100	139
120	140	40	68	60	98	90	130	120	165
140	160	45	74	65	110	108	150	140	191



Deep Groove Ball Bearing	Self-Aligning Ball Bearing	Angular Contact Ball Bearing	
Cylindrical Roller Bearing	Tapered Roller Bearing	Spherical Roller Bearing	
Thrust Ball Bearing	Spherical Roller Thrust Bearing	Accessories Adapter & Withdrawal Sleeve	<b>Technical &amp; Related Information</b>

# 90090m

## Fits and internal clearances

### Single & Double Row Cylindrical Roller Bearings



With interchangeable component parts  
Cylindrical Bore - Clearance to ISO 5753-2009  
Radial Clearance

With **NON** interchangeable component parts  
Cylindrical Part Clearance to ISO 5753-2009  
Radial Clearance



Bore diameter d mm	Clearance group symbol										
	C2		CN		C3		C4		C5		
	over	up to	min.	max.	min.	max.	min.	max.	min.	max.	
2,5	6	-	-	-	-	-	-	-	-	-	
6	10	-	-	-	-	-	-	-	-	-	
10	14	-	-	-	-	-	-	-	-	-	
14	24	0	25	20	45	35	60	50	75	65	90
24	20	0	25	20	45	35	60	50	75	70	95
30	40	5	30	25	50	45	70	60	85	80	105
40	50	5	35	30	60	50	80	70	100	95	125
50	65	10	40	40	70	60	90	80	110	110	140
65	80	10	45	40	75	65	100	90	125	130	165
80	100	15	50	50	85	75	110	105	140	155	190
100	120	15	55	50	90	85	125	125	165	180	220
120	140	15	60	60	105	100	145	145	190	200	245
140	160	20	70	70	120	115	165	165	215	225	275
160	180	25	75	75	125	120	170	170	220	250	300
180	200	35	90	90	145	140	195	195	250	275	330
200	225	45	105	105	165	160	220	220	280	305	365
225	250	45	110	110	175	170	235	235	300	330	395
250	280	55	125	125	195	190	260	260	330	370	440
280	315	55	130	130	205	200	275	275	350	410	485
315	355	65	145	145	225	225	305	305	385	455	535
355	400	100	190	190	280	280	370	370	460	510	600
400	450	110	210	210	310	310	410	410	510	565	665
450	500	110	220	220	330	330	440	440	550	625	735
500	560	120	240	240	360	360	480	480	600	690	810
560	630	140	260	260	380	380	500	500	620	780	900
630	710	145	285	285	425	425	565	565	705	865	1005
710	800	150	310	310	470	470	630	630	790	975	1135
800	900	180	350	350	520	520	690	690	860	1095	1265
900	1000	200	390	390	580	580	770	770	960	1150	1350
1000	1120	220	430	430	640	640	850	850	1060	1310	1570
1120	1250	230	470	470	710	710	950	950	1190	1470	1780
1250	1400	270	530	530	790	790	1050	1050	1310	1610	1930
1400	1600	330	610	610	890	890	1170	1170	1450	1810	2210

Bore diameter d mm	Clearance group symbol											
	C1NA		C2NA		NA		C3NA		C4NA		C5NA	
	min.	max.	min.	max.	min.	max.	min.	max.	min.	max.	min.	max.
0	7	8	15	15	25	30	40	40	50	-	-	-
0	7	10	20	20	30	35	45	45	55	-	-	-
0	10	10	20	20	30	35	45	45	55	-	-	-
5	15	10	20	20	30	35	45	45	55	65	75	
5	15	10	25	25	35	40	50	50	60	70	80	
5	15	12	25	25	40	45	55	55	70	80	95	
5	18	15	30	30	45	50	65	65	80	95	110	
5	20	15	35	35	50	55	75	75	90	110	130	
10	25	20	40	40	60	70	90	90	110	130	150	
10	30	25	45	45	70	80	105	105	125	155	180	
10	30	25	50	50	80	95	120	120	145	180	205	
10	35	30	60	60	90	105	135	135	160	200	230	
10	35	35	65	65	100	115	150	150	180	225	260	
10	40	35	75	75	110	125	165	165	200	250	285	
15	45	40	80	80	120	140	180	180	220	275	315	
15	50	45	90	90	135	155	200	200	240	305	350	
15	50	50	100	100	150	170	215	215	265	330	380	
20	55	55	110	110	165	185	240	240	295	370	420	
20	60	60	120	120	180	205	265	265	325	410	470	
20	65	65	135	135	200	225	295	295	360	455	520	
25	75	75	150	150	225	255	330	330	405	510	585	
25	85	85	170	170	255	285	370	370	455	565	650	
25	95	95	190	190	285	315	410	410	505	625	720	
25	100	105	210	210	315	350	455	455	560	720	815	
30	110	115	230	230	345	390	505	505	620	800	910	
30	130	130	260	260	390	435	565	565	695	900	1030	
35	140	145	290	290	435	485	630	630	775	1000	1140	
35	160	160	320	320	480	540	700	700	860	1130	1290	
35	180	180	360	360	540	600	780	780	960	1270	1440	
50	200	200	400	400	600	660	880	880	1060	1380	1560	
60	220	220	440	440	660	730	950	950	1170	1520	1720	
60	240	240	480	480	720	810	1050	1050	1290	1680	1900	
70	270	270	540	540	810	910	1190	1190	1460	1900	2150	

Fits and internal clearances index

Other fits & internal clearances  
Go to:



Deep Groove Ball Bearings



Self Aligning Ball Bearings



Angular Contact Ball Bearings



Tapered Roller Bearings



Spherical Roller Bearings

1) Radial clearance for bearings with tapered bore is selected from one group to the right, for example radial clearance CN for cylindrical bore bearings match C3 for tapered bore bearings.



Deep Groove Ball Bearing	Self-Aligning Ball Bearing	Angular Contact Ball Bearing	
Cylindrical Roller Bearing	Tapered Roller Bearing	Spherical Roller Bearing	
Thrust Ball Bearing	Spherical Roller Thrust Bearing	Accessories Adapter & Withdrawal Sleeve	Technical & Related Information

# 90090r

## Fits and internal clearances

### Double Row Spherical Roller Bearings



continue ▶

#### Cylindrical bore - Clearance to ISO 5753-2009

Nominal bore diameter d		Symbol of clearance group											
		C1		C2		CN		C3		C4		C5	
mm		Radial clearance of bearing μm											
over	up to	min.	max.	min.	max.	min.	max.	min.	max.	min.	max.	min.	max.
14	24	0	10	10	20	20	35	35	45	45	60	60	75
24	30	0	15	15	25	25	40	40	55	55	75	75	95
30	40	0	15	15	30	30	45	45	60	60	80	80	100
40	50	0	20	20	35	35	55	55	75	75	100	100	125
50	65	0	20	20	40	40	65	65	90	90	120	120	150
65	80	5	30	30	50	50	80	80	110	110	145	145	185
80	100	5	35	35	60	60	100	100	135	135	180	180	225
100	120	5	40	40	75	75	120	120	160	160	210	210	260
120	140	5	50	50	95	95	145	145	190	190	240	240	300
140	160	10	60	60	110	110	170	170	220	220	280	280	350
160	180	10	65	65	120	120	180	180	240	240	310	310	390
180	200	10	70	70	130	130	200	200	260	260	340	340	430
200	225	10	80	80	140	140	220	220	290	290	380	380	470
225	250	15	90	90	150	150	240	240	320	320	420	420	520
250	280	15	100	100	170	170	260	260	350	350	460	460	570
280	315	15	110	110	190	190	280	280	370	370	500	500	630
315	355	20	120	120	200	200	310	310	410	410	550	550	690
355	400	20	130	130	220	220	340	340	450	450	600	600	750
400	450	20	140	140	240	240	370	370	500	500	660	660	820
450	500	20	140	140	260	260	410	410	550	550	720	720	900
500	560	20	150	150	280	280	440	440	600	600	780	780	1000
560	630	30	170	170	310	310	480	480	650	650	850	850	1100
630	710	30	190	190	350	350	530	530	700	700	920	920	1190
710	800	30	210	210	390	390	580	580	770	770	1010	1010	1300
800	900	30	230	230	430	430	650	650	860	860	1120	1120	1440
900	1000	40	260	260	480	480	710	710	930	930	1220	1220	1570



Fits and internal clearances index

Other fits & internal clearances Go to:

Deep Groove Ball Bearings

Self Aligning Ball Bearings

Angular Contact Ball Bearings

Cylindrical Roller Bearings

Tapered Roller Bearings

#### Tapered bore - Clearance to ISO 5753-2009

Nominal bore diameter d		Symbol of clearance group											
		C1		C2		CN		C3		C4		C5	
mm		Radial clearance of bearing μm											
over	up to	min.	max.	min.	max.	min.	max.	min.	max.	min.	max.	min.	max.
18	24	5	15	15	25	25	35	35	45	45	60	60	75
24	30	10	20	20	30	30	40	40	55	55	75	75	95
30	40	15	25	25	35	35	50	50	65	65	85	85	105
40	50	15	30	30	45	45	60	60	80	80	100	100	130
50	65	25	40	40	55	55	75	75	95	95	120	120	160
65	80	30	50	50	70	70	95	95	120	120	150	150	200
80	100	30	55	55	80	80	110	110	140	140	180	180	230
100	120	40	65	65	100	100	135	135	170	170	220	220	280
120	140	50	80	80	120	120	160	160	200	200	260	260	330
140	160	55	90	90	130	130	180	180	230	230	300	300	380
160	180	65	100	100	140	140	200	200	260	260	340	340	430
180	200	70	110	110	160	160	220	220	290	290	370	370	470
200	225	70	120	120	180	180	250	250	320	320	410	410	520
225	250	90	140	140	200	200	270	270	350	350	450	450	570
250	280	90	150	150	220	220	300	300	390	390	490	490	620
280	315	100	170	170	240	240	330	330	430	430	540	540	680
315	355	120	190	190	270	270	360	360	470	470	590	590	740
355	400	130	210	210	300	300	400	400	520	520	650	650	820
400	450	140	230	230	330	330	440	440	570	570	720	720	910
450	500	160	260	260	370	370	490	490	630	630	790	790	1000
500	560	180	290	290	410	410	540	540	680	680	870	870	1100
560	630	200	320	320	460	460	600	600	760	760	980	980	1230
630	710	210	350	350	510	510	670	670	850	850	1090	1090	1360
710	800	230	390	390	570	570	750	750	960	960	1220	1220	1500
800	900	250	440	440	640	640	840	840	1070	1070	1370	1370	1690
900	1000	280	490	490	710	710	930	930	1190	1190	1520	1520	1860

continue ▶



Deep Groove Ball Bearing	Self-Aligning Ball Bearing	Angular Contact Ball Bearing	Technical & Related Information
Cylindrical Roller Bearing	Tapered Roller Bearing	Spherical Roller Bearing	
Thrust Ball Bearing	Spherical Roller Thrust Bearing	Accessories Adapter & Withdrawal Sleeve	



# 90090s

## Fits and internal clearances

### Double Row Spherical Roller Bearings

[back](#)

**Reduction of radial clearance in tapered bore of double row spherical roller bearings, mounted on shaft** - Clearance to ISO 5753-2009

Nominal bore diameter d		Symbol of clearance group											
		C1		C2		CN		C3		C4		C5	
mm		Radial clearance of bearing μm											
over	up to	min.	max.	min.	max.	min.	max.	min.	max.	min.	max.	min.	max.
50	65	0	15	15	30	30	50	50	70	70	90	90	120
65	80	0	20	20	40	40	60	60	80	80	110	110	150
80	100	0	20	20	45	45	70	70	100	100	130	130	170
100	120	0	25	25	50	50	80	80	110	110	150	150	200
120	140	0	30	30	60	60	90	90	120	120	170	170	230
140	160	0	30	30	65	65	100	100	140	140	190	190	260
160	180	0	35	35	70	70	110	110	150	150	210	210	280
180	200	0	40	40	80	80	120	120	170	170	230	230	310
200	225	0	40	40	90	90	140	140	190	190	260	260	340
225	250	0	50	50	100	100	150	150	210	210	290	290	380
250	280	0	50	50	110	110	170	170	230	230	320	320	420
280	315	0	60	60	120	120	180	180	250	250	350	350	460
315	355	0	70	70	140	140	210	210	280	280	390	390	510
355	400	0	70	70	150	150	230	230	310	310	440	440	580
400	450	0	80	80	170	170	260	260	350	350	490	490	650
450	500	0	90	90	190	190	290	290	390	390	540	540	720
500	560	0	100	100	210	210	320	320	430	430	590	590	790
560	630	0	110	110	230	230	350	350	480	480	660	660	880
630	710	0	130	130	260	260	400	400	540	540	740	740	910
710	800	0	140	140	290	290	450	450	610	610	830	830	1100
800	900	0	160	160	330	330	500	500	670	670	920	920	1240



Fits and internal clearances index

Other fits & internal clearances Go to:



Deep Groove Ball Bearings



Self Aligning Ball Bearings



Angular Contact Ball Bearings



Cylindrical Roller Bearings



Tapered Roller Bearings





Deep Groove Ball Bearing	Self-Aligning Ball Bearing	Angular Contact Ball Bearing	Technical & Related Information
Cylindrical Roller Bearing	Tapered Roller Bearing	Spherical Roller Bearing	
Thrust Ball Bearing	Spherical Roller Thrust Bearing	Accessories Adapter & Withdrawal Sleeve	



# 90090t

## Fits and internal clearances

### Double and Four Row Tapered Roller Bearings

Radial clearance of double and four row tapered roller bearings - Clearance to ISO 5753-2009

Nominal bore diameter d	Reduction of radial clearance		Axial displacement on 1:12 taper				Axial displacement on 1:30 taper				Check value of smallest radial clearance after mounting: clearance group			
			On the shaft		On the sleeve		On the shaft		On the sleeve					
mm														
over	up to	min.	max.	min.	max.	min.	max.	min.	max.	min.	max.	CN	C3	C4
30	40	0,02	0,025	0,35	0,4	0,35	0,45	-	-	-	-	0,015	0,025	0,04
40	50	0,025	0,03	0,4	0,45	0,45	0,5	-	-	-	-	0,02	0,03	0,05
50	65	0,03	0,04	0,45	0,6	0,5	0,7	-	-	-	-	0,025	0,035	0,055
65	80	0,04	0,05	0,6	0,75	0,7	0,85	-	-	-	-	0,025	0,04	0,07
80	100	0,045	0,06	0,7	0,9	0,75	1	1,7	2,2	1,8	2,4	0,035	0,05	0,08
100	120	0,05	0,07	0,7	1,1	0,8	1,2	1,9	2,7	2	2,8	0,05	0,065	0,1
120	140	0,065	0,09	1,1	1,4	1,2	1,5	2,7	3,5	2,8	3,6	0,055	0,08	0,11
140	160	0,075	0,1	1,2	1,6	1,3	1,7	3	4	3,1	4,2	0,055	0,09	0,13
160	180	0,08	0,11	1,3	1,7	1,4	1,9	3,2	4,2	3,3	4,6	0,06	0,1	0,15
180	200	0,09	0,13	1,4	2	1,5	2,2	3,5	4,5	3,6	5	0,07	0,1	0,16
200	225	0,1	0,14	1,6	2,2	1,7	2,4	4	5,5	4,2	5,7	0,08	0,12	0,18
225	250	0,11	0,15	1,7	2,4	1,8	2,6	4,2	6	4,6	6,2	0,09	0,13	0,2
250	280	0,12	0,17	1,9	2,6	2	2,9	4,7	6,7	4,8	6,9	0,1	0,14	0,22
280	315	0,13	0,19	2	3	2,2	3,2	5	7,5	5,2	7,7	0,11	0,15	0,24
315	355	0,15	0,21	2,4	3,4	2,6	3,6	6	8,2	6,2	8,4	0,12	0,17	0,26
355	400	0,17	0,23	2,6	3,6	2,9	3,9	6,5	9	5,8	9,2	0,13	0,19	0,29
400	450	0,2	0,26	3,1	4,1	3,4	4,4	7,7	10	8	10,4	0,13	0,2	0,31
450	500	0,21	0,28	3,3	4,4	3,6	4,8	8,2	11	8,4	11,2	0,16	0,23	0,35
500	560	0,24	0,32	3,7	5	4,1	5,4	9,2	12,5	9,6	12,8	0,17	0,25	0,36
560	630	0,26	0,35	4	5,4	4,4	5,9	10	13,5	10,4	14	0,2	0,29	0,41
630	710	0,3	0,4	4,6	6,2	5,1	6,8	11,5	15,5	12	16	0,21	0,31	0,45
710	800	0,34	0,45	5,3	7	5,8	7,6	13,3	17,5	13,6	18	0,23	0,35	0,51
800	900	0,37	0,5	5,7	7,8	6,3	8,5	14,3	19,5	14,8	20	0,27	0,39	0,57
900	1000	0,41	0,55	6,3	8,5	7	9,4	15,8	21	16,4	22	0,3	0,43	0,64
1000	1120	0,45	0,6	6,8	9	7,6	10,2	17	23	18	24	0,32	0,48	0,7
1120	1250	0,49	0,65	7,4	9,8	8,3	11	18,5	25	19,6	26	0,34	0,54	0,77
1250	1400	0,55	0,72	8,3	10,8	9,3	12,1	21	27	22,2	28,3	0,36	0,59	0,84



Fits and internal clearances index

Other fits & internal clearances Go to:



Deep Groove Ball Bearings



Angular Contact Ball Bearings



Self Aligning Ball Bearings



Cylindrical Roller Bearings



Spherical Roller Bearings



Deep Groove Ball Bearing	Self-Aligning Ball Bearing	Angular Contact Ball Bearing	Technical & Related Information
Cylindrical Roller Bearing	Tapered Roller Bearing	Spherical Roller Bearing	
Thrust Ball Bearing	Spherical Roller Thrust Bearing	Accessories Adapter & Withdrawal Sleeve	

# 9 | 0 | 1 | 0 | 0 | a

## Shaft and housing fits

continue

### Shaft tolerances for Cylindrical bore bearings

Type of Load	Bearing type	Diameter	Axial Movement Magnitude of Load	Tolerance field	
Rotating Outer Ring Load	Ball & Roller Bearing	All sizes	Angular contact ball bearing and tapered roller bearing adjustment via inner ring	g6 h6 h6	(g5) (h5) (j6)
Rotating Inner Ring or indeterminate Load	Ball Bearing	Up to 40mm	normal load	J6	(j5)
		Up to 100mm	low load normal & high load	J6 k6	(j5) (k5)
		Up to 200mm	low load normal & high load	K6 m6	(k5) (m5)
		Over 200mm	normal load high load, shock load	M6 n6	(m5) (n5)
-	Roller Bearing	Up to 60mm	low load normal & high load	J6 k6	(j5) (k5)
		Up to 200mm	low load normal load high load	K6 m6 n6	(k5) (m5) (n5)
		Up to 500mm	normal load high load, shock load	m6 p6	(m5)
		Over 500mm	normal load high load	N6 p6	(n5)

### Shaft tolerances for Thrust bearings

Type of Load	Bearing type	Diameter	Operating conditions	Tolerance field	
Thrust load	thrust ball bearings	all sizes		J6	
	trust ball bearings double acting	all sizes		J6	(k6)
	cylindrical roller thrust bearing	all sizes		h6	(j6)
	trust cylindrical roller & cage assembly	all sizes		h10	
	thrust cylindrical roller & cage assembly or thrust needle roller & cage assembly	all sizes		h8	
Combined Load	spherical roller thrust bearing	all sizes	point load on shaft washer	j6	
		up to 200mm	circumferential	j6	(k6)
		over 200 mm	load on shaft washer	k6	(m6)

### Adapter sleeves, withdrawal sleeves

	Permissible geometrical inaccuracy (out-of-roundness taper)	Tolerance field
Adapter sleeves and withdrawal sleeves	IT 5/2	H7
	IT 5/2	h8
	IT 6/2	h9





Deep Groove Ball Bearing	Self-Aligning Ball Bearing	Angular Contact Ball Bearing	
Cylindrical Roller Bearing	Tapered Roller Bearing	Spherical Roller Bearing	
Thrust Ball Bearing	Spherical Roller Thrust Bearing	Accessories Adapter & Withdrawal Sleeve	Technical & Related Information

# 9 0 1 0 0 c

## Shaft and housing fits

[back](#)

### Shaft tolerances for adapter sleeves and withdrawal sleeves

d mm		H7			IT 5/2			h8			IT 5/2			h9			IT 6/2		
μm																			
over	up to	upper	lower	max.	upper	lower	max.	upper	lower	max.	upper	lower	max.	upper	lower	max.	upper	lower	max.
0	0	0	0	0	0	0	0	0	0	0	0	0	0	0	0	0	0	0	0
6	10	0	-15	3	0	-22	3	0	-36	4.5	0	-43	5.5	0	-52	6.5	0	-62	8
10	18	0	-18	4	0	-27	4	0	-43	5.5	0	-52	6.5	0	-62	8	0	-74	9.5
18	30	0	-21	4.5	0	-39	4.5	0	-52	6.5	0	-62	8	0	-74	9.5	0	-87	11
30	50	0	-25	5.5	0	-39	5.5	0	-62	8	0	-74	9.5	0	-87	11	0	-100	12.5
50	80	0	-30	6.5	0	-46	6.5	0	-74	9.5	0	-87	11	0	-100	12.5	0	-115	14.5
80	120	0	-35	7.5	0	-54	7.5	0	-87	11	0	-100	12.5	0	-115	14.5	0	-130	16
120	180	0	-40	9	0	-63	9	0	-100	12.5	0	-115	14.5	0	-130	16	0	-140	18
180	250	0	-46	10	0	-72	10	0	-115	14.5	0	-130	16	0	-140	18	0	-155	20
250	315	0	-52	11.5	0	-81	11.5	0	-130	16	0	-140	18	0	-155	20	0	-165	22
315	400	0	-57	12.5	0	-89	12.5	0	-140	18	0	-155	20	0	-165	22	0	-175	24
400	500	0	-63	13.5	0	-97	13.5	0	-155	20	0	-165	22	0	-175	24	0	-185	26

Note: IT basic tolerances indicate accepted from circularity and cylindricity

### Housing tolerances for radial bearing

Type of Load	Axial Movement Magnitude of Load	Operation Conditions	Tolerance field	
Rotating inner Ring Load	Outer Ring slides in Housing	closeness of tolerance function of running accuracy	H7	(H6)
		high running accuracy	H7	(J6)
		standard running accuracy	H7	(J6)
		temperature increase through shaft	G7	
Rotating Outer Ring Load or indeterminate load	low load	with high running accuracy requirements K6, M6, N6 and P6	K7	(KJ6)
	normal load, shock load		M7	(M6)
	high load, shock load		N7	(N6)
	high load, heavy shock load thin-walled housings		P7	(P6)

### Housing tolerances for thrust bearing

Type of load	Bearing type	Operating conditions	Tolerance field	
Thrust load	thrust ball bearings	standard running accuracy	E8	
		high running accuracy	E6	
	cylindrical roller thrust bearing		H7	(K6)
		thrust cylindrical roller & cage assembly	H11	
		thrust cylindrical roller & cage assembly	H10	
	spherical roller thrust bearing	normal load	E8	
		high load	G7	
Radial & axial loads on spherical roller thrust bearings	stationary load on housing washer		H7	
	rotating load on housing washer		M7	

[back](#)



Deep Groove Ball Bearing	Self-Aligning Ball Bearing	Angular Contact Ball Bearing	Technical & Related Information
Cylindrical Roller Bearing	Tapered Roller Bearing	Spherical Roller Bearing	
Thrust Ball Bearing	Spherical Roller Thrust Bearing	Accessories Adapter & Withdrawal Sleeve	

# 9 | 0 | 1 | 0 | 0 | h

## Shaft and housing machining tolerances



continue ▶

### Accuracy of shaft

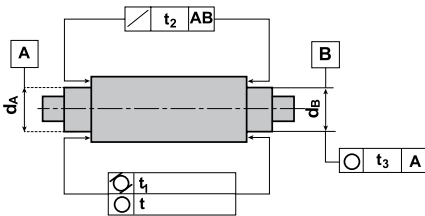

### Accuracy of housing

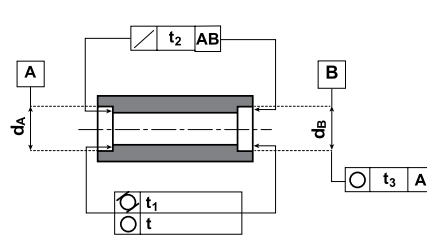

Description	Fit	Symbol of tolerance	Allowable tolerances depending on precision classes				
			P0	P6	P5	P4(SP)	P2(UP)
Dimensional accuracy	shaft	--	IT 6	IT 5	IT 4	IT 4	IT 3
	housing	--	IT 7	IT 6	IT 5	IT 5	IT 4
Roundness	shaft		IT 4	IT 3	IT 2	IT 1	IT 0
	housing	$t_1$	IT 5	IT 4	IT 3	IT 2	IT 1
Cylindricity	shaft		IT 3	IT 3	IT 2	IT 1	IT 0
	housing	$t_2$	IT 4	IT 3	IT 3	IT 2	IT 1
Runout	shaft		IT 3	IT 3	IT 2	IT 1	IT 0
	housing	$t_3$	IT 4	IT 3	IT 2	IT 2	IT 1
Eccentricity	shaft		IT 5	IT 4	IT 4	IT 3	IT 3
	housing	$t_c$	IT 6	IT 5	IT 5	IT 4	IT 3

### Basic tolerance range ISO-IT

$d, D$		IT 0	IT 1	IT 2	IT 3	IT 4	IT 5	IT 6	IT 7	IT 8
from	to	$\mu\text{m}$								
mm										
1	3	0.5	0.8	1.2	2	2	4	6	10	14
3	6	0.6	1	1.5	2.5	4	5	8	12	18
6	10	0.6	1	1.5	2.5	4	6	9	15	22
10	18	0.8	1.2	2	3	5	8	11	18	27
18	30	1	1.5	2.5	4	6	9	13	21	33
30	50	1	1.5	2.5	4	7	11	16	25	39
50	80	1.2	2	3	5	8	13	19	30	46
80	120	1.5	2.5	4	6	10	15	22	35	54
120	180	2	3.5	5	8	12	18	25	40	63
180	250	3	4.5	7	10	14	20	28	46	72
250	315	4	6	8	12	16	23	32	52	81
315	400	5	7	9	13	18	25	36	57	89
400	500	6	8	10	15	20	27	40	63	97



Deep Groove Ball Bearing	Self-Aligning Ball Bearing	Angular Contact Ball Bearing	
Cylindrical Roller Bearing	Tapered Roller Bearing	Spherical Roller Bearing	
Thrust Ball Bearing	Spherical Roller Thrust Bearing	Accessories Adapter & Withdrawal Sleeve	Technical & Related Information

# 9 | 0 | 1 | 0 | 0 | m

## Shaft and housing machining tolerances

Tolerance table

◀ back

### Deviation of shaft diameters 0,001 mm

Nominal diameter		g5		g6		h5		h6		h8		h10		j5	
over	inc	Max	Min	Max	Min	Max	Min	Max	Min	Max	Min	Max	Min	Max	Min
3	6	-4	-9	-4	-12	0	-5	0	-8	0	-18	0	-48	+3	-2
6	10	-5	-11	-5	-14	0	-6	0	-9	0	-22	0	-58	+4	-2
10	18	-6	-4	-6	-17	0	-8	0	-11	0	-27	0	-70	+5	-3
18	30	-7	-16	-7	-20	0	-9	0	-13	0	-33	0	-84	+5	-4
30	50	-9	-20	-9	-25	0	-11	0	-16	0	-39	0	-100	+6	-5
50	80	-10	-23	-10	-29	0	-13	0	-19	0	-46	0	-120	+6	-7
80	120	-12	-27	-12	-34	0	-15	0	-22	0	-54	0	-140	+6	-9
120	180	-14	-32	-14	-39	0	-18	0	-25	0	-63	0	-160	+7	-11
180	250	-15	-35	-15	-44	0	-20	0	-29	0	-72	0	-185	+7	-13
250	315	-17	-40	-17	-49	0	-23	0	-32	0	-81	0	-210	+7	-16
316	400	-18	-43	-18	-54	0	-25	0	-36	0	-89	0	-230	+7	-18
400	500	-20	-47	-20	-60	0	-27	0	-40	0	-97	0	-250	+7	-20

### Deviation of housing diameters 0,001 mm

Nominal diameter		E8		G6		G7		H6		H7		H10		H11		J6	
over	inc	Max	Min	Max	Min	Max	Min	Max	Min	Max	Min	Max	Min	Max	Min	Max	Min
6	10	+47	+25	+14	+5	+20	+5	+9	0	+15	0	+58	0	+90	0	+5	-4
10	18	+59	+32	+17	+6	+24	+6	+11	0	+18	0	+70	0	+110	0	+6	-5
18	30	+73	+40	+20	+7	+28	+7	+13	0	+21	0	+84	0	+130	0	+8	-5
30	50	+89	+50	+25	+9	+34	+9	+16	0	+25	0	+100	0	+160	0	+10	-6
50	80	+106	+60	+29	+10	+40	+10	+19	0	+30	0	+120	0	+190	0	+13	-6
80	120	+126	+72	+34	+12	+47	+12	+22	0	+35	0	+140	0	+220	0	+16	-6
120	180	+148	+85	+39	+14	+54	+14	+25	0	+40	0	+160	0	+250	0	+18	-7
180	250	+172	+100	+44	+15	+61	+15	+29	0	+46	0	+185	0	+290	0	+22	-7
250	315	+191	+110	+49	+17	+69	+17	+32	0	+52	0	+210	0	+320	0	+25	-7
315	400	+214	+125	+54	+18	+75	+18	+36	0	+57	0	+230	0	+360	0	+29	-7
400	500	+232	+135	+60	+20	+83	+20	+40	0	+63	0	+250	0	+400	0	+33	-7

### Deviation of shaft diameters 0,001 mm

Nominal diameter		j6		k5		k6		m5		m6		n5		n6		p6	
over	inc	Max	Min	Max	Min	Max	Min	Max	Min	Max	Min	Max	Min	Max	Min	Max	Min
3	6	+6	-2	+6	+1	+9	+1	+9	+4	+12	+4	+13	+8	+16	+8	+20	+12
6	10	+7	-2	+7	+1	+10	+1	+12	+6	+15	+6	+16	+10	+19	+10	+24	+15
10	18	+8	-3	+9	+	+12	+1	+15	+7	+18	+7	+20	+12	+23	+12	+29	+18
18	30	+9	-4	+11	+2	+15	+2	+17	+8	+21	+8	+24	+15	+28	+15	+35	+22
30	50	+11	-5	+13	+2	+18	+2	+20	+9	+25	+9	+28	+17	+33	+17	+42	+26
50	80	+12	-7	+15	+2	+21	+2	+24	+11	+30	+11	+33	+20	+39	+20	+51	+32
80	120	+13	-9	+18	+3	+25	+3	+28	+13	+35	+13	+38	+23	+45	+23	+59	+37
120	180	+14	-11	+21	+3	+28	+3	+33	+15	+40	+15	+45	+27	+52	+27	+66	+43
180	250	+16	-13	+24	+4	+33	+4	+37	+17	+46	+17	+51	+31	+60	+31	+79	+50
250	315	+16	-16	+27	+4	+36	+4	+43	+20	+52	+20	+57	+34	+66	+34	+88	+56
316	400	+18	-18	+29	+4	+40	+4	+46	+21	+57	+21	+62	+37	+73	+37	+98	+62
400	500	+20	-20	+32	+5	+45	+5	+50	+23	+63	+23	+67	+40	+80	+40	+108	+68

### Deviation of housing diameters 0,001 mm

Nominal diameter		J7		K6		K7		M6		M7		N6		N7		P6		P5	
over	inc	Max	Min	Max	Min	Max	Min	Max	Min	Max	Min	Max	Min	Max	Min	Max	Min	Max	Min
6	10	+8	-7	+2	-7	+5	-10	-3	-12	0	-15	-7	-16	-4	-19	-12	-21	-9	-24
10	18	+10	-8	+2	-9	+6	-12	-4	-15	0	-18	-9	-20	-5	-23	-15	-26	-11	-29
18	30	+12	-9	+2	-11	+6	-15	-4	-17	0	-21	-11	-24	-7	-28	-18	-31	-14	-35
30	50	+14	-11	+3	-13	+7	-18	-4	-20	0	-25	-12	-28	-8	-33	-21	-37	-17	-42
50	80	+18	-12	+4	-15	+9	-21	-5	-24	0	-30	-14	-33	-9	-39	-26	-45	-21	-51
80	120	+22	-13	+4	-18	+10	-25	-6	-28	0	-35	-16	-38	-10	-45	-30	-52	-24	-59
120	180	+26	-14	+4	-21	+12	-28	-8	-33	0	-40	-20	-45	-12	-52	-36	-61	-28	-68
180	250	+30	-16	+5	-24	+13	-33	-8	-37	0	-46	-22	-51	-14	-60	-41	-70	-33	-79
250	315	+36	-16	+5	-27	+16	-36	-9	-41	0	-52	-25	-57	-14	-66	-47	-79	-36	-88
315	400	+39	-18	+7	-29	+17	-40	-10	-46	0	-57	-26	-62	-16	-73	-51	-87	-41	-98
400	500	+43	-20	+8	-32	+18	-45	-10	-50	0	-63	-27	-67	-17	-80	-55	-95	-45	-108

◀ back





Deep Groove Ball Bearing	Self-Aligning Ball Bearing	Angular Contact Ball Bearing	
Cylindrical Roller Bearing	Tapered Roller Bearing	Spherical Roller Bearing	
Thrust Ball Bearing	Spherical Roller Thrust Bearing	Accessories Adapter & Withdrawal Sleeve	Technical & Related Information

## 90100r

## ISO Standards

### FITS

Tolerances for the boundary dimensions of bearings are to ISO standards. To ensure satisfactory performance of the bearing under variable operating conditions, it is necessary to select suitable fits between the inner ring and the shaft and the outer ring and the housing.

When selecting the correct fits from the ISO range of shaft and housing tolerances, it is necessary to consider adequate radial support of the bearing, ease of mounting and dismounting, and allowance for axial movement of the free bearing.

Selection of the fit also depends on the loading on the bearing and on the operating temperature. It should be noted that tight fits reduce the internal clearance of the bearing, and allowance should be made when selecting the bearing clearance.

### TOLERANCES

The boundary dimensions and tolerances of rolling bearings have been standardized by ISO. Bearings are manufactured to normal class 0 tolerances, unless otherwise stated.

Tolerances are also listed for the closer-than-normal limits required, for example, in machine tool and high speed applications.

The more common ISO norms referred to are as follows:

- ISO 15-2011 – Rolling bearings – Radial bearings – Boundary dimensions
- ISO 104-2002 – Thrust bearings with flat housing washers – Boundary dimensions
- ISO 199-2005 – Rolling bearings – Thrust ball bearings – Tolerances
- ISO 355-2007 – Metric tapered roller bearing - Boundary dimensions
- ISO 464-2002 – Rolling bearings with locating snap ring – Dimensions
- ISO 492-2002 – Radial bearings – Tolerances
- ISO 1132-2001 – Rolling bearings – Tolerances – Definitions
- ISO 5753-2009 – Rolling bearings – Radial internal clearances



Deep Groove Ball Bearing	Self-Aligning Ball Bearing	Angular Contact Ball Bearing	
Cylindrical Roller Bearing	Tapered Roller Bearing	Spherical Roller Bearing	
Thrust Ball Bearing	Spherical Roller Thrust Bearing	Accessories Adapter & Withdrawal Sleeve	Technical & Related Information



# 9 0 3 5 5 a

## Precision class tolerance symbols

### Introduction

The dimensional and running accuracies of our bearings are standardized according to ISO.

Precision Class Radial Bearing

Precision Class Tapered Roller Bearing

Precision Class Thrust Bearing

## Rolling Bearing Tolerance Symbol

### Bore Diameter

d	Nominal bore diameter
d1	Nominal large diameter of tapered bore
ds	Single bore diameter
$\Delta ds$	Deviation of a single bore diameter
$\sqrt{ds}$	Bore diameter variation
Dm	Mean bore diameter
$\Delta dm$	Mean bore diameter deviation
Dmp	Single plane mean bore diameter
$\Delta dmp$	Single plane mean bore diameter deviation
$\Delta d1mp$	Deviation of mean large diameter from nominal-tapered bore
$V_{DP}$	Bore diameter variation in a single radial plane
$V_{DMP}$	Mean bore diameter variation
$\alpha$	Taper angle

### Width And Height

B	Nominal inner ring width
V	Nominal outer ring width
Bs	Single inner ring width
Cs	Single outer ring width
$\Delta Bs$	Deviation of a single inner ring width
$\Delta Cs$	Deviation of a single outer ring width
$\sqrt{Bs}$	inner ring width variation
$\sqrt{Cs}$	Outer ring width variation
Bm	Mean inner ring width

### Radial Run Out

Kla	Radial run out of assembled bearing inner ring
Kea	Radial run out of assembled bearing outer ring
Sd	Face run out with bore
SD	Variation of outside surface inclination with face
Sla	Assembled bearing inner ring face run out with raceway
Sea	Assembled bearing outer ring face run out with raceway

### Outside Diameter

D	Nominal outside diameter
Ds	Single outside diameter
$\sqrt{Ds}$	Deviation of a single outside diameter
Dm	Mean outside diameter
$\Delta Dm$	Mean outside diameter deviation
Dmp	Single plane mean outside diameter
$\Delta Dmp$	Single plane outside diameter deviation
$V_{DP}$	Outside diameter variation in a single radial plane
$V_{DMP}$	Mean outside diameter variation

D1	Nominal diameter of outer ring flange
T	Nominal width of tapered roller bearing
$\Delta Ts$	Deviation in width of tapered roller bearing at single position
T1	Nominal width of tapered roller bearing-cone
$\Delta T1s$	Deviation of width of tapered roller bearing-cone
T2	Nominal width of tapered roller bearing-cup
$\Delta T2s$	Deviation of width of tapered roller bearing-cup
d2	Nominal shaft washer diameter – double acting thrust bearing
$\Delta d2p$	Deviation of shaft washer mean bore diameter single plane
Dw	Nominal diameter of roller
Dwm	Mean diameter of roller
Lw	Nominal length of roller



Deep Groove Ball Bearing	Self-Aligning Ball Bearing	Angular Contact Ball Bearing	
Cylindrical Roller Bearing	Tapered Roller Bearing	Spherical Roller Bearing	
Thrust Ball Bearing	Spherical Roller Thrust Bearing	Accessories Adapter & Withdrawal Sleeve	Technical & Related Information



# 9 0 3 5 5 c

## Precision class radial bearing

### Metric size - Precision class P0

### Precision class Tolerance Symbols Index

### Precision class P0 - Inner ring

d mm	Δdmp		V <sub>dp</sub> Diameter ranges			V <sub>dmp</sub>	K <sub>ia</sub>	ΔBs				V <sub>Bs</sub>	
			7,8,9	0,1	2,3,4			Modified <sup>2</sup>					
over	up to	upper	lower	max.			max.	upper	lower	upper	lower	max.	
0,6 <sup>1)</sup>	2,5	0	-8	10	8	6	6	10	0	-40	-	-	12
2,5	10	0	-8	10	8	6	6	10	0	-120	0	-250	15
10	18	0	-8	10	8	6	6	10	0	-120	0	-250	20
18	30	0	-10	13	10	8	8	13	0	-120	0	-250	20
30	50	0	-12	15	12	9	9	15	0	-120	0	-250	20
50	80	0	-15	19	19	11	11	20	0	-150	0	-380	25
80	120	0	-20	25	25	15	15	25	0	-200	0	-380	25
120	180	0	-25	31	31	19	19	30	0	-250	0	-500	30
180	250	0	-30	38	38	23	23	40	0	-300	0	-500	30
250	315	0	-35	44	44	26	26	50	0	-350	0	-500	35
315	400	0	-40	50	50	30	30	60	0	-400	0	-500	40
400	500	0	-45	56	56	34	34	65	0	-450	0	-630	50
500	630	0	-50	63	63	38	38	70	0	-500	-	-	60
630	800	0	-75	-	-	-	80	0	-750	-	-	-	70
800	1000	0	-100	-	-	-	90	0	-1000	-	-	-	80
1000	1250	0	-125	-	-	-	100	0	-1250	-	-	-	100
1250	1600	0	-160	-	-	-	120	0	-1600	-	-	-	120
1600	2000	0	-200	-	-	-	140	0	-2000	-	-	-	140
-	-	-	-	-	-	-	-	-	-	-	-	-	-

Tolerances in μm

- 1) Including this dimension
- 2) Only for bearings mounted in sets

### Outer ring

continue ▶

D mm	ΔDmp		V <sub>dp2</sub> Open Bearings Diameter ranges			Sealed bearings	V <sub>dmp2</sub>	K <sub>ea</sub>	ΔCs	VCs
			7,8,9	0,1	2,3,4					
over	up to	upper	lower	max.			max.	max.		
2,5 <sup>1)</sup>	6	0	-8	10	8	6	10	6	10	Identical with ΔBs and VBs of the inner ring of the same bearing
6	18	0	-8	10	8	6	10	6	10	
18	30	0	-9	12	9	7	12	6	10	
30	50	0	-11	14	11	8	16	8	13	
50	80	0	-13	16	13	10	20	9	15	
80	120	0	-15	19	19	11	26	11	20	
120	150	0	-18	23	23	14	30	15	25	
150	180	0	-25	31	31	19	38	19	30	
180	250	0	-30	38	38	23	-	23	40	
250	315	0	-35	44	44	26	-	26	50	
315	400	0	-40	50	50	30	-	30	60	
400	500	0	-45	56	56	34	-	34	65	
500	630	0	-50	63	63	38	-	38	70	
630	800	0	-75	94	94	55	-	-	80	
800	1000	0	-100	125	125	75	-	-	90	
1000	1250	0	-125	-	-	-	-	-	100	
1250	1600	0	-160	-	-	-	-	-	120	
1600	2000	0	-200	-	-	-	-	-	-	
2000	2500	0	-250	-	-	-	-	-	140	

Tolerances in μm

- 1) Including this dimension
- 2) Main diameter variation before fitting snap rings

## Precision Class Radial Bearings with Tapered bore

### Precision class P0

Tolerances in μm

d mm	Δdmp <sup>1)</sup>		Δd1mp - Δdmp <sup>2)</sup>		√dp <sup>3)</sup>
	over	to	upper	lower	
-	10		+15	0	10
10	18		+18	0	10
18	30		+21	0	13
30	50		+25	0	15
50	80		+30	0	19
80	120		+35	0	25
120	180		+40	0	31
180	250		+46	0	38
250	315		+52	0	44
315	400		+57	0	50
400	500		+63	0	56

- 1) Single plane main bore diameter deviation at smallest theoretical opening
- 2) Main diameter deviation of large diameter less main diameter deviation from smaller diameter
- 3) Bore diameter variation in a single radial plane

Tolerances For Tapered Bores – Taper 1:12  
Nominal dimensions

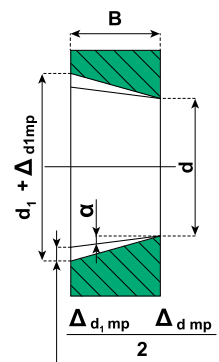

$$\alpha = 2^{\circ}23'9,4'' = 2.38594^{\circ} = 0.041643 \text{ rad}$$

half the angle of taper





Deep Groove Ball Bearing	Self-Aligning Ball Bearing	Angular Contact Ball Bearing	
Cylindrical Roller Bearing	Tapered Roller Bearing	Spherical Roller Bearing	
Thrust Ball Bearing	Spherical Roller Thrust Bearing	Accessories Adapter & Withdrawal Sleeve	Technical & Related Information

# 90355e

## Precision class radial bearings

### Metric size - Precision class P6 - P5 - P4



### Precision class Tolerance Symbols Index

#### Precision class P6 - Inner ring

#### Outer ring

[back](#)

d mm		Δdmp		V <sub>dp</sub> Diameter ranges			V <sub>dpmp</sub>	K <sub>ta</sub>	ΔBs				VBs
				7,8,9	0,1	2,3,4					modified <sup>2)</sup>		
over	up to	upper	lower	max.			max.	max.	upper	lower	upper	lower	max.
0,6 <sup>1)</sup>	2,5	0	-7	9	7	5	5	5	0	-40	-	-	12
2,5	10	0	-7	9	7	5	5	6	0	-120	0	-250	15
10	18	0	-7	9	7	5	5	7	0	-120	0	-250	20
18	30	0	-8	10	8	6	6	8	0	-120	0	-250	20
30	50	0	-10	13	10	8	8	10	0	-120	0	-250	20
50	80	0	-12	15	15	9	9	10	0	-150	0	-380	25
80	120	0	-15	19	19	11	11	13	0	-200	0	-380	25
120	180	0	-18	23	23	14	14	18	0	-250	0	-500	30
180	250	0	-22	28	28	17	17	20	0	-300	0	-500	30
250	315	0	-25	31	31	19	19	25	0	-350	0	-500	35
315	400	0	-30	38	38	23	23	30	0	-400	0	-630	40
400	500	0	-35	44	44	26	26	35	0	-450	-	-	50
500	630	0	-40	50	50	30	30	40	0	-500	-	-	60
-	-	-	-	-	-	-	-	-	-	-	-	-	-
-	-	-	-	-	-	-	-	-	-	-	-	-	-

D mm		ΔDmp		V <sub>Dp</sub> <sup>2)</sup> Open Bearings Diameter ranges			Sealed bearings	V <sub>Dmp</sub> <sup>2)</sup>	K <sub>ea</sub>	ΔCs	VCs
				7,8,9	0,1	2,3,4	2,3,4				
over	up to	upper	lower	max.			max.	max.	max.		
2,5 <sup>1)</sup>	6	0	-7	9	7	5	9	5	8		
6	18	0	-7	9	7	5	9	5	8		
18	30	0	-8	10	8	6	10	6	9		
30	50	0	-9	11	9	7	13	7	10		
50	80	0	-11	14	11	8	16	8	13		
80	120	0	-13	16	16	10	20	10	18		
120	150	0	-15	19	19	11	25	11	20		
150	180	0	-18	23	23	14	30	14	23		
180	250	0	-20	25	25	15	-	15	25		
250	315	0	-25	31	31	19	-	19	30		
315	400	0	-28	35	35	21	-	21	35		
400	500	0	-33	41	41	25	-	25	40		
500	630	0	-38	48	48	29	-	29	50		
630	800	0	-45	56	56	34	-	34	60		
800	1000	0	-60	75	75	45	-	45	75		

Identical with ΔBs and VBs of the inner ring of the same bearing

1) Including this dimension 2) Only for bearings mounted in sets Tolerances in μm

#### Precision class P5 - Inner ring

#### Precision class P5 - Outer ring

d mm		cylindrical bore			Δds		tapered bore				ΔBs	VBs	K <sub>ta</sub>	Sd	Sia
		Δdmp, Δds √ dp					V <sub>dp</sub> Δd1mp - Δdmp								
from	to	lower	upper	max.	lower	upper	max.	lower	upper	lower	upper	max.	max.	max.	max.
18	30	-6	0	3	0	+10	3	0	+4	-100	0	5	3	8	8
30	50	-8	0	4	0	+12	4	0	+6	-120	0	5	4	8	8
50	80	-9	0	5	0	+15	5	0	+6	-150	0	6	4	8	8
80	120	-10	0	5	0	+20	5	0	+8	-200	0	7	5	9	9
120	180	-13	0	7	0	+25	7	0	+8	-250	0	8	6	10	10
180	250	-15	0	8	0	+30	8	0	+10	-300	0	10	8	11	13
250	315	-15	0	9	0	+35	9	0	+12	-350	0	13	8	13	15
315	400	-23	0	12	0	+40	12	0	+12	-400	0	15	10	15	20
400	500	-27	0	14	0	+45	14	0	+14	-400	0	17	10	17	23
-	-	-	-	-	-	-	-	-	-	-	-	-	-	-	-
-	-	-	-	-	-	-	-	-	-	-	-	-	-	-	-

D mm		ΔDmp, ΔDs		V <sub>Dp</sub>	K <sub>ea</sub>	SD	Sea
from	to	lower	upper	max.	max.	max.	max.
30	50	-7	0	4	5	8	8
50	80	-9	0	5	5	8	10
80	120	-10	0	5	6	9	11
120	150	-11	0	6	7	10	13
150	180	-13	0	7	8	10	14
180	250	-15	0	8	10	11	15
250	315	-18	0	9	11	13	18
315	400	-20	0	10	13	13	20
400	500	-23	0	12	15	15	23
500	630	-28	0	14	17	18	25
630	800	-35	0	18	20	20	30

Tolerances in μm

#### Precision class P4 - Inner ring

#### Precision class UP - Outer ring

d mm		cylindrical bore			Δds		tapered bore				ΔBs	VBs	K <sub>ta</sub>	Sd	Sia
		Δdmp, Δds V <sub>dp</sub>					V <sub>dp</sub> Δd1mp - Δdmp								
from	to	lower	upper	max.	lower	upper	max.	lower	upper	lower	upper	max.	max.	max.	max.
18	30	-5	0	2.5	0	+6	2.5	0	+2	-25	0	1.5	1.5	3	3
30	50	-6	0	3	0	+7	3	0	+3	-30	0	2	2	3	3
50	80	-7	0	3.5	0	+8	3.5	0	+3	-40	0	3	2	4	3
80	120	-8	0	4	0	+10	4	0	+4	-50	0	3	3	4	4
120	180	-10	0	5	0	+12	5	0	+4	-60	0	4	3	5	6
180	250	-12	0	6	0	+14	6	0	+5	-75	0	5	4	6	7
250	315	-15	0	8	0	+15	8	0	+6	-100	0	5	4	6	8
315	400	-19	0	10	0	+17	10	0	+6	-100	0	6	5	7	9
400	500	-23	0	12	0	+19	12	0	+7	-100	0	7	5	8	10
-	-	-	-	-	-	-	-	-	-	-	-	-	-	-	-
-	-	-	-	-	-	-	-	-	-	-	-	-	-	-	-

D mm		ΔDmp, ΔDs		V <sub>Dp</sub>	K <sub>ea</sub>	SD	Sea
from	to	lower	upper	max.	max.	max.	max.
30	50	-5	0	3	3	2	4
50	80	-6	0	3	3	2	4
80	120	-7	0	4	3	3	5
120	150	-8	0	4	4	3	6
150	180	-9	0	5	4	3	7
180	250	-10	0	5	5	4	9
250	315	-12	0	6	6	4	9
315	400	-14	0	7	7	5	12
400	500	-17	0	9	8	5	12
500	630	-20	0	10	9	6	14
630	800	-25	0	13	11	7	17

Tolerances in μm



Deep Groove Ball Bearing	Self-Aligning Ball Bearing	Angular Contact Ball Bearing	
Cylindrical Roller Bearing	Tapered Roller Bearing	Spherical Roller Bearing	
Thrust Ball Bearing	Spherical Roller Thrust Bearing	Accessories Adapter & Withdrawal Sleeve	Technical & Related Information



# 9 0 3 5 5 f

## Precision class Tapered Roller Bearing

### Metric size - Precision class P0

Precision class  
Tolerance Symbols  
Index

continue ▶

### Precision class P0 - Inner ring

d mm		ΔDmp		√dp	√dmp	K <sub>ia</sub>
over	up to	upper	lower	max.	max.	max.
10	18	0	-12	12	9	15
18	30	0	-12	12	9	18
30	50	0	-12	12	9	20
50	80	0	-15	15	11	25
80	120	0	-20	20	15	30
120	180	0	-25	25	19	35
180	250	0	-30	30	23	50
250	315	0	-35	35	26	60
315	400	0	-40	40	30	70
-	-	-	-	-	-	-
-	-	-	-	-	-	-

Tolerances in μm

### Outer ring

D mm		ΔDmp		√Dp	√Dmp	K <sub>oa</sub>
over	up to	upper	lower	max.	max.	max.
18	30	0	-12	12	9	18
30	50	0	-14	14	11	20
50	80	0	-16	16	12	25
80	120	0	-18	18	14	35
120	150	0	-20	20	15	40
150	180	0	-25	25	19	45
180	250	0	-30	30	23	50
250	315	0	-35	35	26	60
315	400	0	-40	40	30	70
400	500	0	-45	45	34	80
500	630	0	-50	50	38	100

Tolerances in μm

Note: the limit tolerance of the outer diameter D1 of a flanged bearing is h9

### Precision class P0 - With of inner, outer ring and height

d mm		ΔBS, ΔCS		ΔTS		ΔT1S		ΔT2S	
over	up to	upper	lower	upper	lower	upper	lower	upper	lower
10	18	0	-120	+120	0	+100	0	+100	0
18	30	0	-120	+200	0	+100	0	+100	0
30	50	0	-120	+200	0	+100	0	+100	0
50	80	0	-150	+200	0	+100	0	+100	0
80	120	0	-200	+200	-200	+100	-100	+100	-100
120	180	0	-250	+350	-250	+150	-150	+200	-100
180	250	0	-300	+350	-250	+150	-150	+200	-100
250	315	0	-350	+350	-250	+150	-150	+200	-100
315	400	0	-400	+400	-400	+200	-200	+200	-200

Tolerances in μm

### Precision class P6X

D mm		ΔBs		ΔCs		ΔTs		ΔT1s		ΔT2s	
over	up to	upper	lower	upper	lower	upper	lower	upper	lower	upper	lower
10	18	0	-50	0	-100	+100	0	+50	0	+50	0
18	30	0	-50	0	-100	+100	0	+50	0	+50	0
30	50	0	-50	0	-100	+100	0	+50	0	+50	0
50	80	0	-50	0	-100	+100	0	+50	0	+50	0
80	120	0	-50	0	-100	+100	0	+50	0	+50	0
120	180	0	-50	0	-100	+150	0	+50	0	+100	0
180	250	0	-50	0	-100	+150	0	+50	0	+100	0
250	315	0	-50	0	-100	+200	0	+100	0	+100	0
315	400	0	-50	0	-100	+200	0	+100	0	+100	0

Tolerances in μm

The limit tolerances for The diameter and The radial run-out of The outer ring and The inner ring in this precision class are The same with precision class P0.

The limit tolerances for the width and mounting height for the outer and inner ring are those indicated below.



Deep Groove Ball Bearing	Self-Aligning Ball Bearing	Angular Contact Ball Bearing	
Cylindrical Roller Bearing	Tapered Roller Bearing	Spherical Roller Bearing	
Thrust Ball Bearing	Spherical Roller Thrust Bearing	Accessories Adapter & Withdrawal Sleeve	<b>Technical &amp; Related Information</b>



# 9 | 0 | 3 | 5 | 5 | h

## Precision class Tapered Roller Bearings

### Metric size - Precision class P4 - P5

Precision class  
Tolerance Symbols  
Index

◀ back continue ▶

#### Precision class P5 - Inner ring

d mm		Δdmp		V <sub>dp</sub>	VD <sub>MP</sub>	K <sub>ia</sub>	S <sub>d</sub>	ΔBs		ΔTs	
over	up to	upper	lower	max.	max.	max.	max.	upper	lower	upper	lower
10	18	0	-7	5	5	5	7	0	-200	+200	-200
18	30	0	-8	6	5	5	8	0	-200	+200	-200
30	50	0	-10	8	5	6	8	0	-240	+200	-200
50	80	0	-12	9	6	7	8	0	-300	+200	-200
80	120	0	-15	11	8	8	9	0	-400	+200	-200
120	180	0	-18	14	9	11	10	0	-500	+350	-250
180	250	0	-22	17	11	13	11	0	-600	+350	-250
-	-	-	-	-	-	-	-	-	-	-	-
-	-	-	-	-	-	-	-	-	-	-	-

Tolerances in μm

#### Outer ring

D mm		ΔDmp		V <sub>dp</sub>	VD <sub>MP</sub>	K <sub>ea</sub>	SD	ΔCs
over	up to	upper	lower	max.	max.	max.	max.	
18	30	0	-8	6	5	6	8	Identical with ΔBs of the inner ring of the same bearing
30	50	0	-9	7	5	7	8	
50	80	0	-11	8	6	8	8	
80	120	0	-13	10	7	10	9	
120	150	0	-15	11	8	11	10	
150	180	0	-18	14	9	13	10	
180	250	0	-20	15	10	15	11	
250	315	0	-25	19	13	18	13	
315	400	0	-28	22	14	20	13	

Tolerances in μm

The limit tolerance of the outer diameter D<sub>1</sub> of a flanged bearing is h9.

#### Precision class P4 - Inner ring

d mm		Δdmp, ds		V <sub>dp</sub>	VD <sub>MP</sub>	K <sub>ia</sub>	S <sub>d</sub>	S <sub>ia</sub>	ΔBs		ΔTs	
over	up to	upper	lower	max.	max.	max.	max.	max.	upper	lower	upper	lower
10	18	0	-5	4	4	3	3	3	0	-200	+200	-200
18	30	0	-6	5	4	3	4	4	0	-200	+200	-200
30	50	0	-8	6	5	4	4	4	0	-240	+200	-200
50	80	0	-9	7	5	4	4	4	0	-300	+200	-200
80	120	0	-10	8	5	5	5	5	0	-400	+200	-200
120	180	0	-13	10	7	6	7	7	0	-500	+350	-250
180	250	0	-15	11	8	8	8	8	0	-600	+350	-250
-	-	-	-	-	-	-	-	-	-	-	-	-
-	-	-	-	-	-	-	-	-	-	-	-	-

Tolerances in μm

#### Outer ring

D mm		ΔDmp, ΔDs		V <sub>dp</sub>	VD <sub>MP</sub>	K <sub>ea</sub>	SD	Sea	ΔCs
over	up to	upper	lower	max.	max.	max.	mas.	max.	Upper / lower
18	30	0	-6	5	4	4	4	5	Identical with ΔBs of the inner ring of the same bearing
30	50	0	-7	5	5	5	4	5	
50	80	0	-9	7	5	5	4	5	
80	120	0	-10	8	5	6	5	6	
120	150	0	-11	8	6	7	5	7	
150	180	0	-13	10	7	8	5	8	
180	250	0	-15	11	8	10	7	10	
250	315	0	-18	14	9	11	8	10	
315	400	0	-20	15	10	13	10	13	

Tolerances in μm



Deep Groove Ball Bearing	Self-Aligning Ball Bearing	Angular Contact Ball Bearing	
Cylindrical Roller Bearing	Tapered Roller Bearing	Spherical Roller Bearing	
Thrust Ball Bearing	Spherical Roller Thrust Bearing	Accessories Adapter & Withdrawal Sleeve	<b>Technical &amp; Related Information</b>



# 9 | 0 | 3 | 5 | 5 | k

## Precision class Tapered Roller Bearings

### Inch size – Precision according AFBMA standard

Precision class  
Tolerance Symbols  
Index

◀ back

#### Inner ring

d mm		Precision classes									
		4		2		3		0		00	
over	up to	upper	lower	upper	lower	upper	lower	upper	lower	upper	lower
-	76.2	+13	0	+13	0	+13	0	+13	0	+8	0
76.2	304.2	+25	0	+25	0	+13	0	+13	0	+8	0
304.2	609.6	+51	0	+51	0	+25	0	-	-	-	-
609.6	914.4	+76	0	-	-	+38	0	-	-	-	-
914.4	1219.2	+102	0	-	-	+51	0	-	-	-	-
1219.2	-	+127	0	-	-	+76	0	-	-	-	-

Tolerances in µm

#### Outer ring

D mm		Precision classes									
		4		2		3		0		00	
over	up to	upper	lower	upper	lower	upper	lower	upper	lower	upper	lower
-	304.8	+25	0	+25	0	+13	0	+13	0	+8	0
304.8	609.6	+51	0	+51	0	+25	0	-	-	-	-
609.6	912.4	+76	0	+76	0	+38	0	-	-	-	-
914.4	1219.2	+102	0	-	-	+51	0	-	-	-	-
1219.2	-	+127	0	-	-	+76	0	-	-	-	-
-	-	-	-	-	-	-	-	-	-	-	-

Tolerances in µm

#### Radial run-out of an assembled bearings

d mm		Precision classes				
		4	2	3	0	00
over	up to	max.	max.	max.	max.	max.
-	304.8	51	38	8	4	2
304.8	609.6	51	38	18	-	-
609.6	914.4	76	51	51	-	-
914.4	-	76	-	76	-	-
-	-	-	-	-	-	-

Tolerances in µm

#### Tolerances for mounting height ΔTs

d mm		D mm		Precision classes									
				4		2		3		0		00	
over	up to	over	up to	upper	lower	upper	lower	upper	lower	upper	lower	upper	lower
-	101.6	-	-	+203	0	+203	0	+203	-203	+203	-203	+203	-203
101.6	304.8	-	-	+356	-254	+203	0	+203	-203	+203	-203	+203	-203
304.8	609.6	-	508.0	+318	-381	+381	-381	+203	-203	-	-	-	-
304.8	609.6	508.0	-	+318	-381	+318	-381	+381	-381	-	-	-	-
609.6	-	-	-	+318	-381	-	-	+381	-381	-	-	-	-

Tolerances in µm

#### Tolerances for the mounting height on the inner ring roller sub-assembly with outer ring (ΔT1S)

d mm		D mm		Precision classes									
				4		2		3		0		00	
over	up to	over	up to	upper	lower	upper	lower	upper	lower	upper	lower	upper	lower
-	101.6	-	-	+102	0	+102	0	+102	-102	+102	-102	+102	-102
101.6	304.8	-	-	+152	-152	+102	0	+102	-102	+102	-102	+102	-102
304.8	609.6	-	508.0	+178	-178	+178	-178	+102	-102	-	-	-	-
304.8	609.6	508.0	-	+178	-178	+178	-178	+178	-178	-	-	-	-
609.6	-	-	-	+178	-178	-	-	+178	-178	-	-	-	-

Tolerances in µm

#### Tolerances for the mounting height on the inner ring roller sub-assembly with outer ring (ΔT2S)

d mm		D mm		Precision classes									
				4		2		3		0		00	
over	up to	over	up to	upper	lower	upper	lower	upper	lower	upper	lower	upper	lower
-	101.6	-	-	+102	0	+102	0	+102	-102	+102	-102	+102	-102
101.6	304.8	-	-	+203	-102	+102	0	+102	-102	+102	-102	+102	-102
304.8	609.6	-	508.0	+203	-203	+203	-203	+102	-102	-	-	-	-
304.8	609.6	508.0	-	+203	-203	+203	-203	+203	-203	-	-	-	-
609.6	-	-	-	+203	-203	-	-	+203	-203	-	-	-	-

Tolerances in µm



Deep Groove Ball Bearing	Self-Aligning Ball Bearing	Angular Contact Ball Bearing	
Cylindrical Roller Bearing	Tapered Roller Bearing	Spherical Roller Bearing	
Thrust Ball Bearing	Spherical Roller Thrust Bearing	Accessories Adapter & Withdrawal Sleeve	Technical & Related Information

## 9 0 3 5 5 m

## Precision class Thrust Bearing

### Metric size - Precision class P5 - P6



Precision class  
Tolerance Symbols  
Index

### Single acting thrust bearing (single row)

#### Shaft Washer

d mm		P0; P6; P5			P4; P2		
		$\Delta d_{mp}$ $\Delta d_{2mp}$		$V_{dp}$ $VD_{zP}$	$\Delta d_{mp}$ $\Delta d_{2mp}$		$V_{dp}$ $VD_{zP}$
over	up to	upper	lower	max.	upper	lower	max.
-	18	0	-8	6	0	-7	5
18	30	0	-10	8	0	-8	6
30	50	0	-12	9	0	-10	8
50	80	0	-15	11	0	-12	9
80	120	0	-20	15	0	-15	11
120	180	0	-25	19	0	-18	14
180	250	0	-30	23	0	-22	17
250	315	0	-35	26	0	-25	19
315	400	0	-40	30	0	-30	23
400	500	0	-45	34	0	-35	26
500	630	0	-50	38	0	-40	30
630	800	0	-75	-	0	-50	-
800	1000	0	-100	-	-	-	-
1000	1250	0	-125	-	-	-	-
-	-	-	-	-	-	-	-

Tolerances in  $\mu m$

#### Housing Washer

d mm		P0; P6; P5			P4; P2		
		$VD_{MP}$		$V_{dp}$	$\Delta d_{mp}$		$V_{dp}$
over	up to	upper	lower	max.	upper	lower	max.
10	18	0	-11	8	0	-7	5
18	30	0	-13	10	0	-8	6
30	50	0	-16	12	0	-9	7
50	80	0	-19	14	0	-11	8
80	120	0	-22	17	0	-13	10
120	180	0	-25	19	0	-15	11
180	250	0	-30	23	0	-20	15
250	315	0	-35	26	0	-25	19
315	400	0	-40	30	0	-28	21
400	500	0	-45	34	0	-33	25
500	630	0	-50	38	0	-38	29
630	800	0	-75	55	0	-45	34
800	1000	0	-100	75	0	-	-
1000	1250	0	-125	-	0	-	-
1250	1600	0	-160	-	0	-	-

Tolerances in  $\mu m$

### Double acting thrust bearing (double row)

#### Precision class P5 and P6 - Inner ring

d mm		P5			P6			P5 and P6					
		$\Delta d_{mp}$		$\Delta d_s$	$S_{ia}$	$\Delta d_s$		$S_{ia}$	$H_s$		$C_s$		
over	up to	upper	lower	upper	lower	max.	upper	lower	max.	upper	lower	upper	lower
16	18	0	-7	+1	-8	3	0	-5	1.5	+50	-80	0	-30
18	30	0	-8	+1	-9	3	0	-6	1.5	+50	-80	0	-30
30	50	0	-10	+1	-11	3	0	-8	1.5	+60	-100	0	-30
50	80	0	-12	+2	-14	4	0	-9	2	+70	-120	0	-30
80	120	0	-15	+3	-18	4	0	-10	2	+85	-140	0	-30
120	180	0	-18	+3	-21	5	0	-13	3	+95	-160	0	-30
180	250	0	-22	+4	-26	5	0	-15	3	+120	-200	0	-30

Tolerances in  $\mu m$

#### Precision class P5 and P6 - Outer ring

D mm		SP and UP		
		$\Delta D_S$		$S_{ea}$
over	up to	upper	lower	max.
30	50	-20	-27	Identical with the inner ring of the same bearing
50	80	-24	-33	
80	120	-28	-38	
120	150	-33	-44	
150	180	-33	-46	
180	250	-37	-52	
250	315	-41	-59	

Tolerances in  $\mu m$

### Single & Double acting thrust bearing

d* mm		S <sub>i</sub>					S <sub>e</sub>
		P0;	P6;	P5;	P4;	P2	P0; P6; P5; P4; P2
over	up to	max.	max.	max.	max.	max.	
-	18	10	5	3	2	1	Identical with S1 of the shaft washer
18	30	10	5	3	2	1.2	
30	50	10	6	3	2	1.5	
50	80	10	7	4	3	2	
80	120	15	8	4	3	2	
120	180	15	9	5	4	3	
180	250	20	10	5	4	3	
250	315	25	13	7	5	4	
315	400	30	15	7	5	4	
400	500	30	18	9	6	-	
500	630	35	21	11	7	-	
630	800	40	25	13	8	-	
800	1000	45	30	15	-	-	
1000	1250	50	35	18	-	-	

Tolerances in  $\mu m$

Values for S<sub>i</sub> and S<sub>e</sub> for double-acting thrust bearings are equal to the values corresponding to single-acting thrust bearings and are depending on the bore diameter d, of single-acting bearings.



Deep Groove Ball Bearing	Self-Aligning Ball Bearing	Angular Contact Ball Bearing	
Cylindrical Roller Bearing	Tapered Roller Bearing	Spherical Roller Bearing	
Thrust Ball Bearing	Spherical Roller Thrust Bearing	Accessories Adapter & Withdrawal Sleeve	Technical & Related Information



# 9 | 0 | 3 | 7 | 0 | a

## Abutments

### Introduction & guidelines

#### Filet Radii

The bearing tables give the maximum fillet radius which the bearing will clear.

A fillet radius which is too large can cause distortion of the bearing ring, and may cause misalignment of the bearing relative to the seating.

#### Abutment Shoulders

These must be flat, aligned with the axis of rotation, and free from burrs, to maintain bearing alignment and give proper support to the bearing faces.

#### Minimum Abutment Diameter

Minimum abutment diameters for bearings not subject to significant axial load are:

Inner ring abutment =  $d + 4r$  (maximum)

Outer ring abutment =  $D - 4r$  (minimum)

where:

$d$  = bearing bore diameter

$r$  = fillet radius (from bearing tables)

$D$  = bearing outside diameter

#### Maximum Abutment Diameters

The normal recommendations concerning maximum abutments for radial ball and standard cylindrical roller bearings are given in tables.

It may not always be possible for small bearings to satisfy the minimum abutment recommendations, and in such cases the abutment should be made to the maximum figure in the table.

#### Abutments For Thrust Bearings

Thrust bearing abutments must be accurately machined flat and aligned with the axis of rotation, as any misalignment will induce creep. The thrust bearing washers should be supported beyond the pitch diameter of the ball assembly. This may be calculated as:

$$Pcd = (d+D)/2$$

where:

$d$  = small bore diameter

$D$  = large outside diameter

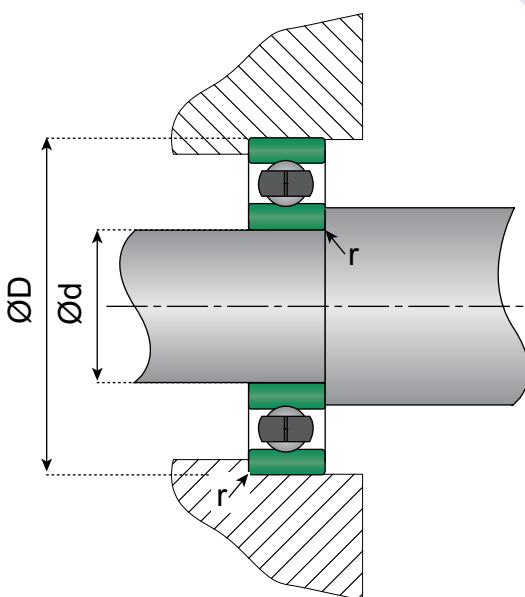

**Deep Groove Ball Bearings**

**Self Aligning Ball Bearings**

**Cylindrical Roller Bearings**  
Single Row

**Angular Contact Bearings**  
Single Row



Deep Groove Ball Bearing	Self-Aligning Ball Bearing	Angular Contact Ball Bearing	
Cylindrical Roller Bearing	Tapered Roller Bearing	Spherical Roller Bearing	
Thrust Ball Bearing	Spherical Roller Thrust Bearing	Accessories Adapter & Withdrawal Sleeve	Technical & Related Information



# 9 | 0 | 3 | 7 | 2 | a

## Abutments

### Deep Groove Ball Bearings

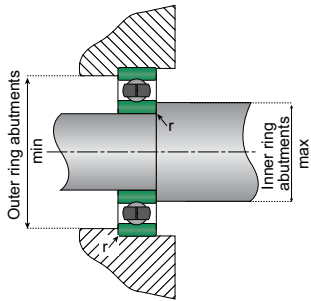

Open version

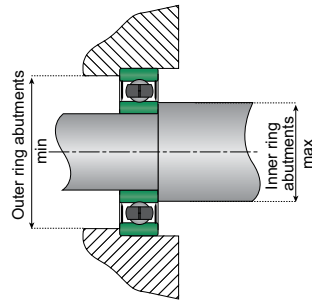

ZZ & 2RS version



Series 600	Inner ring abutment mm	Outer ring abutment mm	Series 600 ZZ-2RS	Inner ring abutment mm	Outer ring abutment mm
607	9.4	15.8	607 ZZ-2RS	9.4	16.5
608	11.0	19.0	608 ZZ-2RS	10.5	19.5
609	12.8	20.7	609 ZZ-2RS	12.8	21.2
623	4.8	7.9	623 ZZ-2RS	4.8	8.8
624	6.4	11.1	624 ZZ-2RS	6.4	11.3
625	6.8	13.2	625 ZZ-2RS	6.8	13.9
626	9.4	15.8	626 ZZ-2RS	9.0	16.5
627	11.1	19.0	627 ZZ-2RS	10.5	19.5
629	13.2	22.8	629 ZZ-2RS	12.5	23.5
634	6.8	13.2	634 ZZ-2RS	6.8	13.9
635	9.4	15.8	635 ZZ-2RS	9.0	16.5
636	11.1	19.0	636 ZZ-2RS	10.5	19.5

Abutments other version  
Deep groove Ball Bearing

Series  
6200-6300

General  
Guidelines

Series 6000 ZZ-2RS	Inner ring abutment mm	Outer ring abutment mm
6000 ZZ-2RS	12.5	23.0
6001 ZZ-2RS	14.5	25.0
6002 ZZ-2RS	18.0	28.5
6003 ZZ-2RS	20.5	31.5
6004 ZZ-2RS	30.0	42.0
6005 ZZ-2RS	30.0	42.0
6006 ZZ-2RS	35.5	50.0
6007 ZZ-2RS	41.0	56.5
6008 ZZ-2RS	46.0	62.0
6009 ZZ-2RS	51.5	70.0
6010 ZZ-2RS	57.0	74.5
6011 ZZ-2RS	63.0	82.5
6012 ZZ-2RS	67.5	88.0
6013 ZZ-2RS	73.0	92.5
6014 ZZ-2RS	78.5	102.0

Series 16000	Inner ring abutment mm	Outer ring abutment mm
16000	12.5	23.0
16001	15.0	25.0
16002	18.5	29.0
16003	20.0	32.0
16004	30.0	42.0
16005	30.0	42.0
16006	36.0	49.0
16007	42.0	55.0
16008	47.0	60.5
16009	52.5	67.5
16010	57.5	72.5
16011	64.5	80.5
16012	69.5	85.5
16013	74.5	90.5
16014	80.0	100.0
16015	85.0	105.0
16016	92.0	113.0
16017	97.0	118.0
16018	103.0	127.0



Deep Groove Ball Bearing	Self-Aligning Ball Bearing	Angular Contact Ball Bearing	Technical & Related Information
Cylindrical Roller Bearing	Tapered Roller Bearing	Spherical Roller Bearing	
Thrust Ball Bearing	Spherical Roller Thrust Bearing	Accessories Adapter & Withdrawal Sleeve	

# 9 0 3 7 2 c

## Abutments

### Deep Groove Ball Bearings

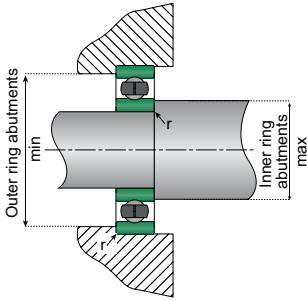

Open version

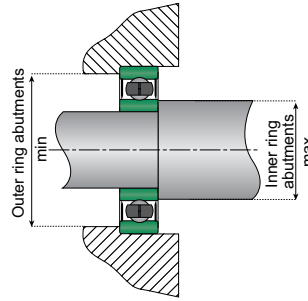

ZZ & 2RS version



Series 6200	Inner ring abutment mm	Outer ring abutment mm	Series 6200 ZZ-2RS	Inner ring abutment mm	Outer ring abutment mm
6200	15.0	25.5	6200 ZZ-2RS	15.0	26.0
6201	16.5	28.0	6201 ZZ-2RS	16.0	28.0
6202	19.5	31.0	6202 ZZ-2RS	19.0	31.0
6203	22.0	35.0	6203 ZZ-2RS	22.0	35.5
6204	26.0	41.0	6204 ZZ-2RS	26.0	42.5
6205	31.0	46.5	6205 ZZ-2RS	31.0	47.5
6206	37.5	55.5	6206 ZZ-2RS	37.5	56.5
6207	43.5	64.5	6207 ZZ-2RS	43.5	65.5
6208	49.0	71.5	6208 ZZ-2RS	49.0	73.5
6209	53.5	76.5	6209 ZZ-2RS	53.0	77.5
6210	59.0	81.5	6210 ZZ-2RS	59.0	83.5
6211	65.0	90.5	-	-	-
6212	71.0	100.0	6212 ZZ-2RS	71.0	101.5
6213	77.0	108.5	-	-	-
6214	81.5	114.0	6214 ZZ-2RS	81.5	115.5
6215	86.5	118.5	-	-	-
6216	94.0	129.5	-	-	-
6217	98.5	137.0	-	-	-
6218	105.5	145.5	-	-	-
6219	111.0	154.5	-	-	-
6220	117.0	162.0	-	-	-
6221	124.5	172.5	-	-	-
6222	130.0	181.0	-	-	-
6223	-	-	-	-	-
6224	140.5	195.0	-	-	-
6225	154.0	208.5	-	-	-
6226	166.0	225.0	-	-	-
6227	192.0	260.5	-	-	-

Abutments other version  
Deep groove Ball Bearing

Series 600  
6000-1600

General  
Guidelines

Series 6300	Inner ring abutment mm	Outer ring abutment mm	Series 6300 ZZ-2RS	Inner ring abutment mm	Outer ring abutment mm
6300	16.0	29.0	6300 ZZ-2RS	16.0	30.0
6301	17.5	31.5	6301 ZZ-2RS	17.5	33.0
6302	21.0	36.5	6302 ZZ-2RS	21.0	37.5
6303	23.5	40.5	6303 ZZ-2RS	23.5	41.0
6304	27.0	45.0	6304 ZZ-2RS	27.0	45.5
6305	34.0	55.0	6305 ZZ-2RS	34.0	55.5
6306	39.0	63.0	6306 ZZ-2RS	39.0	63.5
6307	45.0	70.0	6307 ZZ-2RS	45.0	70.0
6308	50.5	79.5	6308 ZZ-2RS	50.5	79.0
6309	56.6	88.5	6309 ZZ-2RS	56.5	88.5
6310	63.0	96.5	6310 ZZ-2RS	63.0	96.5
6311	69.5	106.5	6311 ZZ-2RS	69.5	108.5
6312	75.0	115.0	-	-	-
6313	82.0	125.5	-	-	-
6314	87.0	133.5	-	-	-
6315	93.0	142.5	-	-	-
6316	99.0	152.0	-	-	-
6317	104.5	160.5	-	-	-
6318	111.5	169.0	-	-	-
6319	118.5	177.5	-	-	-
6320	127.5	188.5	-	-	-
6321	131.5	198.5	-	-	-
6322	138.5	212.0	-	-	-





Deep Groove Ball Bearing	Self-Aligning Ball Bearing	Angular Contact Ball Bearing	Technical & Related Information
Cylindrical Roller Bearing	Tapered Roller Bearing	Spherical Roller Bearing	
Thrust Ball Bearing	Spherical Roller Thrust Bearing	Accessories Adapter & Withdrawal Sleeve	



# 9 0 3 7 4 d

## Abutments

### Self Aligning Ball Bearings

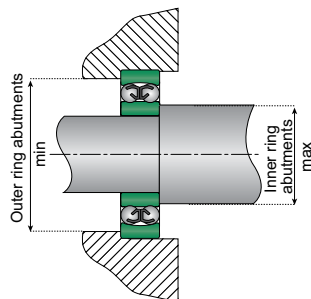

Open version



Series 1200	Inner ring abutment mm	Outer ring abutment mm
1200	15.0	25.5
1201	16.5	28.0
1202	19.5	31.0
1203	22.0	35.0
1204	26.0	41.0
1205	31.0	46.5
1206	37.5	55.5
1207	43.5	64.5
1208	49.0	71.5
1209	53.5	76.5
1210	59.0	81.5
1211	65.0	90.5
1212	71.0	100.0
1213	77.0	108.5
1214	81.5	114.0
1215	86.5	118.5
1216	94.0	129.5
1217	98.5	137.0
1218	105.5	145.5
1219	111.0	154.5
1220	117.0	142.0
1221	124.5	172.5
1222	130.0	181.0
1223	-	-
1224	140.5	195.0
1225	154.0	208.5
1226	166.0	225.0
1227	192.0	260.5

Series 1300	Inner ring abutment mm	Outer ring abutment mm
1300	16.0	29.0
1301	17.5	31.5
1302	21.0	36.5
1303	23.5	40.5
1304	27.0	45.0
1305	34.0	55.0
1306	39.0	63.0
1307	45.0	70.0
1308	50.5	79.5
1309	56.6	88.5
1310	63.0	96.5
1311	69.5	106.5
1312	75.0	115.0
1313	82.0	125.5
1314	87.0	133.5
1315	93.0	142.5
1316	99.0	152.0
1317	104.5	160.5
1318	111.5	169.0
1319	118.5	177.5
1320	127.5	188.5
1321	131.5	198.5
1322	138.5	212.0
1225	154.0	208.5
1226	166.0	225.0
1227	192.0	260.5

### General Guidelines



Deep Groove Ball Bearing	Self-Aligning Ball Bearing	Angular Contact Ball Bearing	Technical & Related Information
Cylindrical Roller Bearing	Tapered Roller Bearing	Spherical Roller Bearing	
Thrust Ball Bearing	Spherical Roller Thrust Bearing	Accessories Adapter & Withdrawal Sleeve	



# 9 | 0 | 3 | 7 | 4 | f

## Abutments

### Single Row Cylindrical Roller Bearings

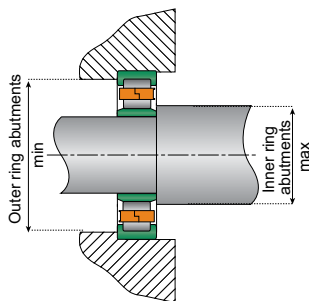

Open version



Series N 200	Series NU 200	Inner ring abutment mm	Outer ring abutment mm
N 200	NU 200	15.0	25.5
N 201	NU 201	16.5	28.0
N 202	NU 202	19.5	31.0
N 203	NU 203	22.0	35.0
N 204	NU 204	26.0	41.0
N 205	NU 205	31.0	46.5
N 206	NU 206	37.5	55.5
N 207	NU 207	43.5	64.5
N 208	NU 208	49.0	71.5
N 209	NU 209	53.5	76.5
N 210	NU 210	59.0	81.5
N 211	NU 211	65.0	90.5
N 212	NU 212	71.0	100.0
N 213	NU 213	77.0	108.5
N 214	NU 214	81.5	114.0
N 215	NU 215	86.5	118.5
N 216	NU 216	94.0	129.5
N 217	NU 217	98.5	137.0
N 218	NU 218	105.5	145.5
N 219	NU 219	111.0	154.5
N 220	NU 220	117.0	162.0
N 221	NU 221	124.5	172.5
N 222	NU 222	130.0	181.0
N 223	NU 223		
N 224	NU 224	140.5	195.0
N 225	NU 225	154.0	208.5
N 226	NU 226	166.0	225.0
N 227	NU 227	192.0	260.5

Series NJ 200	Series NUP 200	abutment mm	abutment mm
NJ 200	NUP 200	16.5	24.0
NJ 201	NUP 201	18.0	26.0
NJ 202	NUP 202	21.0	29.0
NJ 203	NUP 203	24.0	33.0
NJ 204	NUP 204	28.5	38.5
NJ 205	NUP 205	33.5	43.5
NJ 206	NUP 206	40.0	52.5
NJ 207	NUP 207	45.5	60.0
NJ 208	NUP 208	52.0	67.0
NJ 209	NUP 209	57.0	72.0
NJ 210	NUP 210	62.5	77.5
NJ 211	NUP 211	69.0	86.0
NJ 212	NUP 212	76.0	94.0
NJ 213	NUP 213	82.5	102.0
NJ 214	NUP 214	87.5	107.0
NJ 215	NUP 215	91.5	112.0
NJ 216	NUP 216	98.5	122.0
NJ 217	NUP 217	105.5	130.0
NJ 218	NUP 218	110.5	137.0
NJ 219	NUP 219	118.0	147.0
NJ 220	NUP 220	124.5	154.0
NJ 221	NUP 221	138.0	171.5

### General Guidelines

Series N 300	Series NU 300	Inner ring abutment mm	Outer ring abutment mm
N 300	NU 300	16.0	29.0
N 301	NU 301	17.5	31.5
N 302	NU 302	21.0	36.5
N 303	NU 303	23.5	40.5
N 304	NU 304	27.0	45.0
N 305	NU 305	34.0	55.0
N 306	NU 306	39.0	63.0
N 307	NU 307	45.0	70.0
N 308	NU 308	50.5	79.5
N 309	NU 309	56.6	88.5
N 310	NU 310	63.0	96.5
N 311	NU 311	69.5	106.5
N 312	NU 312	75.0	115.0
N 313	NU 313	82.0	125.5
N 314	NU 314	87.0	133.5
N 315	NU 315	93.0	142.5
N 316	NU 316	99.0	152.0
N 317	NU 317	104.5	160.5
N 318	NU 318	111.5	169.0
N 319	NU 319	118.5	177.5
N 320	NU 320	127.5	188.5
N 321	NU 321	131.5	198.5
N 322	NU 322	138.5	212.0

Series NJ 300	Series NUP 300	Inner ring abutment mm	Outer ring abutment mm
NJ 302	NUP 302	23.5	33.5
NJ 304	NUP 304	30.0	42.5
NJ 305	NUP 305	37.0	52.0
NJ 306	NUP 306	44.0	59.0
NJ 307	NUP 307	48.5	66.0
NJ 308	NUP 308	56.0	74.0
NJ 309	NUP 309	61.5	82.0
NJ 310	NUP 310	68.5	90.5
NJ 311	NUP 311	74.0	99.0
NJ 312	NUP 312	81.0	108.0
NJ 313	NUP 313	88.0	117.0
NJ 314	NUP 314	94.5	124.0
NJ 315	NUP 315	100.5	132.5
NJ 316	NUP 316	108.5	142.0
NJ 317	NUP 317	113.5	150.0
NJ 318	NUP 318	120.5	157.5
NJ 319	NUP 319	127.5	166.0
NJ 320	NUP 320	136.0	177.5
NJ 322	NUP 322	150.5	197.0



Deep Groove Ball Bearing	Self-Aligning Ball Bearing	Angular Contact Ball Bearing	
Cylindrical Roller Bearing	Tapered Roller Bearing	Spherical Roller Bearing	
Thrust Ball Bearing	Spherical Roller Thrust Bearing	Accessories Adapter & Withdrawal Sleeve	Technical & Related Information



# 9 | 0 | 3 | 7 | 4 | h

## Abutments

### Single Row Angular Contact Bearings

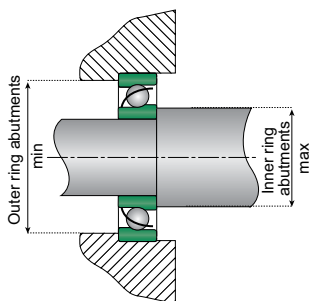

Open version



Series 7200	Inner ring abutment mm	Outer ring abutment mm
7200	16.5	24.0
7201	18.0	26.0
7202	21.0	29.0
7203	24.0	33.0
7204	28.5	38.5
7205	33.5	43.5
7206	40.0	52.5
7207	45.5	60.0
7208	52.0	67.0
7209	57.0	72.0
7210	62.5	77.5
7211	69.0	86.0
7212	76.0	94.0
7213	82.5	102.0
7214	87.5	107.0
7215	91.5	112.0
7216	98.5	122.0
7217	105.5	130.0
7218	110.5	137.0
7219	118.0	147.0
7220	124.5	154.0
7221	138.0	171.5

Series 7300	Inner ring abutment mm	Outer ring abutment mm
7302	23.5	33.5
7304	30.0	42.5
7305	37.0	52.0
7306	44.0	59.0
7307	48.5	66.0
7308	56.0	74.0
7309	61.5	82.0
7310	68.5	90.5
7311	74.0	99.0
7312	81.0	108.0
7313	88.0	117.0
7314	94.5	124.0
7315	100.5	132.5
7316	108.5	142.0
7317	113.5	150.0
7318	120.5	157.5
7319	127.5	166.0
7320	136.0	177.5
7322	150.5	197.0

### General Guidelines



Deep Groove Ball Bearing	Self-Aligning Ball Bearing	Angular Contact Ball Bearing	
Cylindrical Roller Bearing	Tapered Roller Bearing	Spherical Roller Bearing	
Thrust Ball Bearing	Spherical Roller Thrust Bearing	Accessories Adapter & Withdrawal Sleeve	Technical & Related Information



# 90400a

## Groove for snap rings

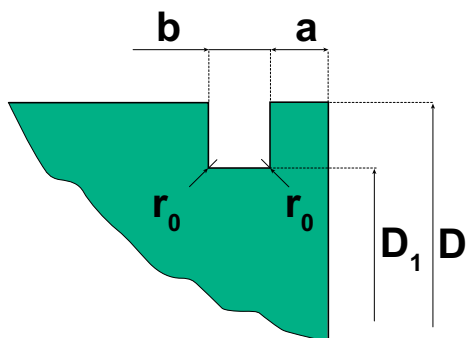

Dimensions  
snap rings

Bearing outer diameter	Size of snap ring groove in mm								
	D1		A Series of sizes 2.3.4				b	r <sub>0</sub>	
	max.	min.	max.	min.	max.	min.	max.	min.	max.
30	28.17	27.92	-	-	2.06	1.9	1.65	1.35	0.4
32	30.15	29.9	2.06	1.9	2.06	1.9	1.65	1.35	0.4
35	33.17	32.92	2.06	1.9	1.06	1.9	1.65	1.35	0.4
37	34.77	34.52	-	-	2.06	1.9	1.65	1.35	0.4
40	38.1	37.85	-	-	2.06	1.9	1.65	1.35	0.4
42	39.75	39.5	2.06	1.9	2.06	1.9	1.65	1.35	0.4
44	41.75	41.5	2.06	1.9	-	-	1.65	1.35	0.4
47	44.6	44.35	2.06	1.9	2.46	2.31	1.65	1.35	0.4
50	47.6	47.35	-	-	2.46	2.31	1.65	1.35	0.4
52	49.73	49.48	2.06	1.9	2.46	2.31	1.65	1.35	0.4
55	52.6	52.35	2.08	1.88	-	-	1.65	1.35	0.4
56	53.06	53.35	-	-	2.46	2.31	1.65	1.35	0.4
58	55.6	55.35	1.08	1.88	2.46	2.31	1.65	1.35	0.4
62	59.61	59.11	2.08	1.88	3.28	3.07	2.2	1.9	0.6
65	62.6	62.1	-	-	3.28	3.07	2.2	1.9	0.6
68	64.82	64.31	2.49	2.29	3.28	3.07	2.2	1.9	0.6
72	68.81	68.3	-	-	3.28	3.07	2.2	1.9	0.6
75	71.83	71.32	2.49	2.29	3.28	3.07	2.2	1.9	0.6
80	76.31	76.3	2.49	2.29	3.28	3.07	2.2	1.9	0.6
85	81.81	81.31	-	-	3.28	3.07	2.2	1.9	0.6
90	86.79	86.28	2.87	2.67	3.28	3.07	3	2.7	0.6
95	91.82	91.31	2.87	2.67	-	-	3	2.7	0.6
100	96.8	96.29	2.87	2.67	3.28	3.07	3	2.7	0.6
110	106.81	10.63	2.87	2.67	3.28	3.07	3	2.7	0.6
115	111.81	11.13	2.87	2.67	-	-	3	2.7	0.6
120	115.21	114.71	-	-	4.06	3.86	3.4	3.1	0.6
125	120.22	119.71	2.87	2.67	4.06	3.86	3.4	3.1	0.6
130	125.22	124.71	2.87	2.67	4.06	3.86	3.4	3.1	0.6
140	135.23	134.72	3.71	3.45	4.9	4.64	3.4	3.1	0.6
145	140.23	139.73	3.71	3.45	-	-	3.4	3.1	0.6
150	145.24	144.73	3.71	3.45	4.9	4.65	3.4	3.1	0.6
160	155.22	154.71	3.71	3.45	4.9	4.65	3.4	3.1	0.6
170	163.65	163.14	3.71	3.45	5.69	5.44	3.8	3.5	0.6
180	173.66	173.15	3.71	3.45	5.69	5.44	3.8	3.5	0.6
190	183.64	183.13	-	-	5.69	5.44	3.8	3.5	0.6
200	193.65	193.14	5.69	5.44	5.69	5.44	3.8	3.5	0.6
215	208.6	208.1	-	-	5.69	5.44	3.8	3.5	1



Deep Groove Ball Bearing	Self-Aligning Ball Bearing	Angular Contact Ball Bearing	
Cylindrical Roller Bearing	Tapered Roller Bearing	Spherical Roller Bearing	
Thrust Ball Bearing	Spherical Roller Thrust Bearing	Accessories Adapter & Withdrawal Sleeve	Technical & Related Information

# 90401a

## Snap rings

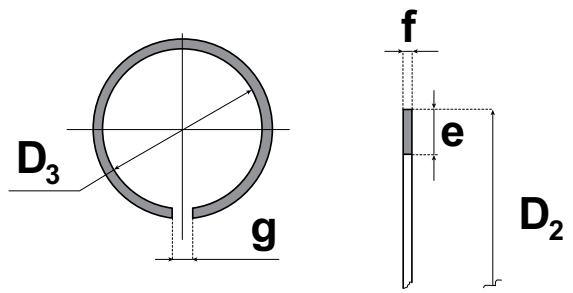

**Dimensions groove for snap rings**

Size of snap ring									Weight g	Snap ring number
D <sub>2</sub>	D <sub>3</sub>	ΔD <sub>3s</sub>		e		f		g		
max.	nominal	upper	lower	max.	min.	max.	min.			
34.7	27.9	0	-0.4	3.25	3.1	1.12	1.02	3	2.78	SP30
36.7	29.9	0	-0.4	3.25	3.1	1.12	1.02	3	2.98	SP32
39.7	32.9	0	-0.4	3.25	3.1	1.12	1.02	3	3.22	SP35
41.3	34.5	0	-0.4	3.25	3.1	1.12	1.02	3	3.36	SP37
44.6	37.8	0	-0.4	3.25	3.1	1.12	1.02	3	3.6	SP40
46.3	39.5	0	-0.5	3.25	3.1	1.12	1.02	3	3.75	SP42
48.3	41.5	0	-0.5	3.25	3.1	1.12	1.02	3	4	SP44
52.7	44.3	0	-0.5	4.04	3.89	1.12	1.02	4	5.78	SP50
57.9	49.3	0	-0.5	4.04	3.89	1.12	1.02	4	5.92	SP52
60.7	52.3	0	-0.5	4.04	3.89	1.12	1.02	4	6.17	SP55
61.7	53.2	0	-0.6	4.04	3.89	1.12	1.02	4	6.45	SP56
63.7	55.2	0	-0.6	4.04	3.89	1.12	1.02	4	6.67	SP58
67.7	59.0	0	-0.6	4.04	3.89	1.7	1.6	4	10.5	SP62
70.7	62.0	0	-0.6	4.04	3.89	1.7	1.6	4	11	SP65
74.6	64.2	0	-0.6	4.85	4.7	1.7	1.6	5	12.6	SP68
78.6	68.2	0	-0.6	4.85	4.7	1.7	1.6	5	14.7	SP72
81.6	71.2	0	-0.6	4.85	4.7	1.7	1.6	5	15.3	SP75
86.6	76.2	0	-0.6	4.85	4.7	1.7	1.6	5	16.3	SP80
91.6	81.2	0	-0.6	4.85	4.7	1.7	1.6	5	17.5	SP85
96.5	86.2	0	-0.6	4.85	4.7	2.46	2.36	5	26.6	SP90
101.6	91.2	0	-0.6	4.85	4.7	2.46	2.36	5	28.2	SP95
106.6	96.2	0	-0.8	4.85	4.7	2.46	2.36	5	29.2	SP100
116.6	106.2	0	-0.8	4.85	4.7	2.46	2.36	5	32.8	SP110
121.6	112.2	0	-0.8	4.85	4.7	2.46	2.36	5	34.4	SP115
129.7	114.6	0	-0.8	7.21	7.06	2.82	2.72	7	60.6	SP120
134.7	119.6	0	-0.8	7.21	7.06	2.82	2.72	7	63	SP125
139.7	124.6	0	-0.8	7.21	7.06	2.82	2.72	7	65.6	SP130
149.7	134.6	0	-1.2	7.21	7.06	2.82	2.72	7	70.6	SP140
154.7	139.6	0	-1.2	7.21	7.06	2.82	2.72	7	73	SP145
159.7	114.5	0	-1.2	7.21	7.06	2.82	2.72	7	77.2	SP150
169.7	154.5	0	-1.2	7.21	7.06	2.28	2.72	7	81	SP160
182.9	162.9	0	-1.2	9.6	9.45	3.1	3	10	122	SP170
192.9	172.8	0	-1.2	9.6	9.45	3.1	3	10	128	SP180
202.9	182.8	0	-1.4	9.6	9.45	3.1	3	10	139	SP190
212.9	192.8	0	-1.4	9.6	9.45	3.1	3	10	148	SP200
227.8	277.6	0	-1.4	9.6	9.45	3.1	3	10	160	SP215

Dimensions D<sub>2</sub> and g refer to the snap ring fitted in to the bearing groove D<sub>3</sub> represents the nominal inner diameter of the snap ring before mounting.



Deep Groove Ball Bearing	Self-Aligning Ball Bearing	Angular Contact Ball Bearing	
Cylindrical Roller Bearing	Tapered Roller Bearing	Spherical Roller Bearing	
Thrust Ball Bearing	Spherical Roller Thrust Bearing	Accessories Adapter & Withdrawal Sleeve	Technical & Related Information

# 95100a

## Page codes index

Item description	Page code	Item description	Page code	Item description	Page code	Item description	Page code
108	25100a	1315	25100b	3211	30100b	6034	20100m
126	25100a	1316	25100b	3212	30100b	6036	20100m
127	25100a	1317	25100b	3213	30100b	6038	20100m
129	25100a	1318	25100b	3214	30100b	6056	20100n
135	25100a	1319	25100b	3215	30100b	6060	20100n
607	20100a	1320	25100b	3216	30100b	6064	20100n
608	20100a	1322	25100b	3217	30100b	6068	20100n
609	20100a	2200	25100a	3218	30100b	6084	20100r
623	20100a	2201	25100a	3219	30100b	6088	20100r
624	20100a	2202	25100a	3220	30100b	6096	20100r
625	20100a	2203	25100a	3222	30100b	6200	20100b
626	20100a	2204	25100a	3302	30100b	6201	20100b
627	20100a	2205	25100a	3303	30100b	6202	20100b
628	20100a	2206	25100a	3304	30100b	6203	20100c
629	20100a	2207	25100a	3305	30100b	6204	20100c
634	20100a	2208	25100a	3306	30100b	6205	20100c
635	20100a	2209	25100b	3307	30100b	6206	20100d
636	20100a	2210	25100b	3308	30100b	6207	20100d
637	20100a	2211	25100b	3309	30100b	6208	20100d
638	20100a	2212	25100b	3310	30100b	6209	20100e
639	20100a	2213	25100b	3311	30100b	6210	20100e
1200	25100a	2214	25100b	3312	30100b	6211	20100e
1201	25100a	2215	25100b	3313	30100b	6212	20100f
1202	25100a	2216	25100b	3314	30100b	6213	20100f
1203	25100a	2217	25100b	3315	30100b	6214	20100f
1204	25100a	2218	25100b	3316	30100b	6215	20100h
1205	25100a	2220	25100b	3317	30100b	6216	20100h
1206	25100a	2222	25100b	3318	30100b	6217	20100h
1207	25100a	2301	25100a	3319	30100b	6218	20100h
1208	25100a	2302	25100a	3320	30100b	6219	20100k
1209	25100b	2303	25100a	3322	30100b	6220	20100k
1210	25100b	2304	25100a	6000	20100b	6221	20100k
1211	25100b	2305	25100a	6001	20100b	6222	20100k
1212	25100b	2306	25100a	6002	20100b	6224	20100k
1213	25100b	2307	25100a	6003	20100c	6226	20100m
1214	25100b	2308	25100b	6004	20100c	6228	20100m
1215	25100b	2309	25100b	6005	20100c	6230	20100m
1216	25100b	2310	25100b	6007	20100d	6232	20100m
1217	25100b	2311	25100b	6008	20100d	6234	20100m
1218	25100b	2312	25100b	6009	20100e	6236	20100m
1219	25100b	2313	25100b	6010	20100e	6238	20100m
1220	25100b	2314	25100b	6011	20100e	6244	20100n
1222	25100b	2315	25100b	6012	20100f	6248	20100n
1300	25100a	2316	25100b	6013	20100f	6256	20100n
1301	25100a	2317	25100b	6014	20100f	6260	20100n
1302	25100a	2318	25100b	6015	20100h	6264	20100n
1303	25100a	2320	25100b	6016	20100h	6268	20100n
1304	25100a	3200	30100b	6017	20100h	6300	20100b
1305	25100a	3201	30100b	6018	20100h	6301	20100b
1306	25100a	3202	30100b	6019	20100k	6302	20100b
1307	25100a	3203	30100b	6020	20100k	6303	20100c
1308	25100a	3204	30100b	6021	20100k	6304	20100c
1309	25100b	3205	30100b	6022	20100k	6305	20100c
1310	25100b	3206	30100b	6024	20100k	6306	20100d
1311	25100b	3207	30100b	6026	20100m	6307	20100d
1312	25100b	3208	30100b	6028	20100m	6308	20100d
1313	25100b	3209	30100b	6030	20100m	6309	20100e
1314	25100b	3210	30100b	6032	20100m	6310	20100e



Deep Groove Ball Bearing	Self-Aligning Ball Bearing	Angular Contact Ball Bearing	
Cylindrical Roller Bearing	Tapered Roller Bearing	Spherical Roller Bearing	
Thrust Ball Bearing	Spherical Roller Thrust Bearing	Accessories Adapter & Withdrawal Sleeve	Technical & Related Information

## 95100b

## Page codes index

Item description	Page code	Item description	Page code	Item description	Page code	Item description	Page code
6311	20100e	16032	20100m	30322	40100d	32048	40100e
6312	20100f	16034	20100m	30324	40100d	32052	40100e
6313	20100f	16038	20100m	30326	40100d	32056	40100e
6314	20100f	16044	20100n	30330	40100d	32060	40100e
6315	20100h	16056	20100n	30332	40100d	32064	40100e
6316	20100h	16064	20100n	30334	40100d	32204	40100a
6317	20100h	16068	20100n	30352	40100e	32205	40100a
6318	20100h	16072	20100n	30660	40100e	32206	40100a
6319	20100k	16076	20100r	30664	40100e	32207	40100a
6320	20100k	30202	40100a	30672	40100e	32208	40100a
6321	20100k	30203	40100a	30680	40100e	32209	40100a
6322	20100k	30204	40100a	30692	40100e	32210	40100b
6324	20100k	30205	40100a	30696	40100e	32211	40100b
6326	20100m	30206	40100a	31306	40100a	32212	40100b
6328	20100m	30207	40100a	31307	40100a	32213	40100b
6330	20100m	30208	40100a	31308	40100a	32214	40100b
6344	20100n	30209	40100a	31309	40100a	32215	40100c
6356	20100n	30210	40100b	31310	40100b	32216	40100c
6405	20100c	30211	40100b	31311	40100b	32217	40100c
6406	20100d	30212	40100b	31312	40100b	32218	40100c
6407	20100d	30213	40100b	31313	40100b	32219	40100c
6408	20100d	30214	40100b	31315	40100c	32220	40100c
6409	20100e	30215	40100c	31316	40100c	32221	40100d
6410	20100e	30216	40100c	31317	40100c	32222	40100d
6411	20100e	30217	40100c	31318	40100c	32224	40100d
6412	20100f	30219	40100c	31319	40100c	32226	40100d
6413	20100f	30220	40100c	31320	40100c	32228	40100d
6414	20100f	30221	40100d	31322	40100d	32230	40100d
6415	20100h	30222	40100d	31324	40100d	32232	40100d
6416	20100h	30224	40100d	31326	40100d	32234	40100d
6417	20100h	30226	40100d	32004	40100a	32238	40100e
6418	20100h	30230	40100d	32005	40100a	32240	40100e
16001	20100b	30232	40100d	32006	40100a	32244	40100e
16002	20100b	30234	40100d	32007	40100a	32248	40100e
16003	20100c	30236	40100e	32008	40100a	32252	40100e
16004	20100c	30238	40100e	32009	40100a	32304	40100a
16005	20100c	30240	40100e	32010	40100b	32305	40100a
16006	20100d	30244	40100e	32011	40100b	32306	40100a
16007	20100d	30302	40100a	32012	40100b	32307	40100a
16008	20100d	30303	40100a	32013	40100b	32308	40100a
16009	20100e	30304	40100a	32014	40100b	32309	40100a
16010	20100e	30305	40100a	32015	40100c	32310	40100b
16011	20100e	30306	40100a	32016	40100c	32311	40100b
16012	20100f	30307	40100a	32017	40100c	32312	40100b
16013	20100f	30308	40100a	32018	40100c	32313	40100b
16014	20100f	30309	40100a	32019	40100c	32314	40100b
16015	20100h	30310	40100b	32020	40100c	32315	40100c
16016	20100h	30311	40100b	32021	40100d	32316	40100c
16017	20100h	30312	40100b	32022	40100d	32317	40100c
16018	20100h	30313	40100b	32024	40100d	32319	40100c
16019	20100k	30314	40100b	32028	40100d	32320	40100c
16020	20100k	30315	40100c	32030	40100d	32321	40100d
16021	20100k	30316	40100c	32032	40100d	32322	40100d
16022	20100k	30317	40100c	32034	40100d	32324	40100d
16024	20100k	30318	40100c	32036	40100e	32326	40100d
16026	20100m	30319	40100c	32038	40100e	32330	40100d
16028	20100m	30320	40100c	32040	40100e	32938	40100e
16030	20100m	30321	40100d	32044	40100e	32940	40100e





Deep Groove Ball Bearing	Self-Aligning Ball Bearing	Angular Contact Ball Bearing	
Cylindrical Roller Bearing	Tapered Roller Bearing	Spherical Roller Bearing	
Thrust Ball Bearing	Spherical Roller Thrust Bearing	Accessories Adapter & Withdrawal Sleeve	Technical & Related Information

# 95100c

## Page codes index

Item description	Page code	Item description	Page code	Item description	Page code	Item description	Page code
32944	40100e	51112	50100a	52217	50100c	61822	20100k
32948	40100e	51113	50100a	52218	50100c	61824	20100k
32952	40100e	51114	50100a	52220	50100c	61826	20100m
32956	40100e	51115	50100a	52222	50100c	61830	20100m
32960	40100e	51116	50100a	52224	50100c	61832	20100m
32964	40100e	51117	50100a	52226	50100c	61836	20100m
32968	40100e	51118	50100b	52305	50100c	61838	20100m
32972	40100e	51120	50100b	52306	50100c	61880	20100r
33005	40100a	51122	50100b	52307	50100c	61884	20100r
33009	40100a	51201	50100a	52308	50100c	61896	20100r
33010	40100b	51202	50100a	52309	50100c	61900	20100b
33013	40100b	51203	50100a	52310	50100c	61901	20100b
33014	40100b	51204	50100a	52311	50100c	61902	20100b
33015	40100c	51205	50100a	52312	50100c	61903	20100c
33016	40100c	51206	50100a	52313	50100c	61904	20100c
33017	40100c	51207	50100a	52314	50100c	61905	20100c
33018	40100c	51208	50100a	52315	50100c	61906	20100d
33019	40100c	51209	50100a	52316	50100c	61907	20100d
33020	40100c	51210	50100a	52317	50100c	61908	20100d
33021	40100d	51211	50100a	52318	50100c	61909	20100e
33022	40100d	51212	50100a	52320	50100c	61910	20100e
33024	40100d	51213	50100a	52322	50100c	61916	20100h
33030	40100d	51214	50100a	52324	50100c	61922	20100k
33109	40100a	51215	50100a	52405	50100c	61924	20100k
33110	40100b	51216	50100a	52406	50100c	61936	20100m
33111	40100b	51217	50100a	52407	50100c	61960	20100n
33112	40100b	51218	50100b	52408	50100c	61964	20100n
33113	40100b	51220	50100b	52409	50100c	61976	20100r
33114	40100b	51222	50100b	52410	50100c	61980	20100r
33115	40100c	51305	50100a	52411	50100c	61992	20100r
33116	40100c	51306	50100a	52412	50100c	16036 M	20100m
33117	40100c	51307	50100a	52413	50100c	16040 M	20100n
33118	40100c	51308	50100a	52420	50100c	16048 M	20100n
33120	40100c	51309	50100a	60872	20100n	16052 M	20100n
33121	40100d	51310	50100a	60880	20100r	21307 GMEX	45100a
33122	40100d	51311	50100a	60888	20100r	21308 C	45100a
33124	40100d	51312	50100a	60964	20100n	21308 GMEX	45100a
33205	40100a	51313	50100a	60980	20100r	21309 C	45100a
33207	40100a	51314	50100a	60988	20100r	21309 GMEX	45100a
33209	40100a	51315	50100a	61800	20100b	21310 C	45100a
33210	40100b	51316	50100a	61801	20100b	21310 GMEX	45100a
33212	40100b	51317	50100a	61802	20100b	21311 C	45100a
33213	40100b	51318	50100b	61803	20100c	21311 GMEX	45100a
33214	40100b	51320	50100b	61804	20100c	21311 MA C4 F80	45100a
33215	40100c	52202	50100c	61805	20100c	21312 C	45100b
33216	40100c	52204	50100c	61806	20100d	21312 CA	45100b
51100	50100a	52205	50100c	61807	20100d	21312 GMEX	45100b
51101	50100a	52206	50100c	61808	20100d	21313 C	45100b
51102	50100a	52207	50100c	61809	20100e	21313 CA	45100b
51103	50100a	52208	50100c	61810	20100e	21313 GMEX	45100b
51104	50100a	52209	50100c	61811	20100e	21314 C	45100b
51105	50100a	52210	50100c	61812	20100f	21314 CA	45100b
51106	50100a	52211	50100c	61813	20100f	21314 GMEX	45100b
51107	50100a	52212	50100c	61814	20100f	21315 C	45100b
51108	50100a	52213	50100c	61816	20100h	21315 CA	45100b
51109	50100a	52214	50100c	61817	20100h	21315 GMEX	45100b
51110	50100a	52215	50100c	61818	20100h	21316 C	45100c
51111	50100a	52216	50100c	61820	20100k	21316 CA	45100c





Deep Groove Ball Bearing	Self-Aligning Ball Bearing	Angular Contact Ball Bearing	
Cylindrical Roller Bearing	Tapered Roller Bearing	Spherical Roller Bearing	
Thrust Ball Bearing	Spherical Roller Thrust Bearing	Accessories Adapter & Withdrawal Sleeve	Technical & Related Information

# 95100d

## Page codes index

Item description	Page code	Item description	Page code	Item description	Page code	Item description	Page code
21316 GMEX	45100c	22217 C	45100c	22248 GMEX	45100x	22315 C 2RS	45100b
21317 C	45100c	22217 CA	45100c	22248 MB	45100x	22315 CA	45100b
21317 CA	45100c	22217 GMEX	45100c	22252 CA	45100x	22315 GMEX	45100b
21317 GMEX	45100c	22217 MB	45100c	22252 MB	45100x	22315 MA C4 F80	45100b
21318 C	45100c	22218 C	45100c	22256 C	45100z	22315 MB	45100b
21318 GMEX	45100c	22218 CA	45100c	22256 CA	45100z	22315 VS C4 F80	45100b
21319 CA	45100d	22218 GMEX	45100c	22256 MB	45100z	22316 C	45100c
21319 GMEX	45100d	22218 MB	45100c	22260 CA	45100z	22316 C 2RS	45100c
21319 MB	45100d	22219 C	45100d	22260 MB	45100z	22316 CA	45100c
21320 CA	45100d	22219 CA	45100d	22264 CA	45101a	22316 GMEX	45100c
21320 GMEX	45100d	22219 GMEX	45100d	22264 MB	45101a	22316 MA C4 F80	45100c
21320 MB	45100d	22219 MB	45100d	22272 CA	45101a	22316 MB	45100c
21322 MB	45100e	22220 C	45100d	22308 C	45100a	22316 VS C4 F80	45100c
2205 2RS	25100a	22220 CA	45100d	22308 C 2RS	45100a	22317 C	45100c
2206 2RS	25100a	22220 GMEX	45100d	22308 CA	45100a	22317 C 2RS	45100c
2207 2RS	25100a	22220 MB	45100d	22308 GMEX	45100a	22317 CA	45100c
2208 2RS	25100a	22222 C	45100e	22308 MB	45100a	22317 GMEX	45100c
2209 2RS	25100b	22222 CA	45100e	22308 VS C4 F80	45100a	22317 MA C4 F80	45100c
2210 2RS	25100b	22222 GMEX	45100e	22309 C	45100a	22317 MB	45100c
22205 C	45100a	22222 MB	45100e	22309 C 2RS	45100a	22317 VS C4 F80	45100c
22205 CA	45100a	22224 C	45100f	22309 CA	45100a	22318 C	45100c
22205 GMEX	45100a	22224 CA	45100f	22309 GMEX	45100a	22318 C 2RS	45100c
22206 C	45100a	22224 GMEX	45100f	22309 MB	45100a	22318 CA	45100c
22206 GMEX	45100a	22224 MB	45100f	22309 VS C4 F80	45100a	22318 GMEX	45100c
22207 C	45100a	22226 C	45100h	22310 C	45100a	22318 MA C4 F80	45100c
22207 CA	45100a	22226 CA	45100h	22310 C 2RS	45100a	22318 MB	45100c
22207 GMEX	45100a	22226 GMEX	45100h	22310 CA	45100a	22318 VS C4 F80	45100c
22208 C	45100a	22226 MB	45100h	22310 GMEX	45100a	22319 C	45100d
22208 CA	45100a	22228 C	45100m	22310 MA C4 F80	45100a	22319 C 2RS	45100d
22208 GMEX	45100a	22228 CA	45100m	22310 MB	45100a	22319 CA	45100d
22209 C	45100a	22228 GMEX	45100m	22310 VS C4 F80	45100a	22319 GMEX	45100d
22209 CA	45100a	22228 MB	45100m	22311 C	45100a	22319 MA C4 F80	45100d
22209 GMEX	45100a	22230 C	45100n	22311 C 2RS	45100a	22319 MB	45100d
22210 C	45100a	22230 CA	45100n	22311 CA	45100a	22319 VS C4 F80	45100d
22210 CA	45100a	22230 GMEX	45100n	22311 GMEX	45100a	22320 C	45100d
22210 GMEX	45100a	22230 MB	45100n	22311 MA C4 F80	45100a	22320 C 2RS	45100d
22211 C	45100a	22232 C	45100r	22311 VS C4 F80	45100a	22320 CA	45100d
22211 CA	45100a	22232 CA	45100r	22312 C	45100b	22320 GMEX	45100d
22211 GMEX	45100a	22232 GMEX	45100r	22312 C 2RS	45100b	22320 MA C4 F80	45100d
22212 C	45100b	22232 MB	45100r	22312 CA	45100b	22320 MB	45100d
22212 CA	45100b	22233 CA	45100r	22312 GMEX	45100b	22320 VS C4 F80	45100d
22212 GMEX	45100b	22234 C	45100s	22312 MA C4 F80	45100b	22322 C	45100e
22212 MB	45100b	22234 CA	45100s	22312 MB	45100b	22322 C 2RS	45100e
22213 C	45100b	22234 GMEX	45100s	22312 VS C4 F80	45100b	22322 CA	45100e
22213 CA	45100b	22234 MB	45100s	22313 C	45100b	22322 GMEX	45100e
22213 GMEX	45100b	22236 C	45100t	22313 C 2RS	45100b	22322 MA C4 F80	45100e
22213 MB	45100b	22236 CA	45100t	22313 CA	45100b	22322 MB	45100e
22214 C	45100b	22236 GMEX	45100t	22313 GMEX	45100b	22322 VS C4 F80	45100e
22214 CA	45100b	22236 MB	45100t	22313 MA C4 F80	45100b	22324 C	45100f
22214 GMEX	45100b	22238 CA	45100u	22313 MB	45100b	22324 C 2RS	45100s
22215 C	45100b	22238 GMEX	45100u	22313 VS C4 F80	45100b	22324 CA	45100f
22215 CA	45100b	22238 MB	45100u	22314 C	45100b	22324 GMEX	45100f
22215 GMEX	45100b	22240 CA	45100v	22314 C 2RS	45100b	22324 MA C4 F80	45100f
22215 MB	45100b	22240 GMEX	45100v	22314 CA	45100b	22324 MB	45100f
22216 C	45100c	22244 CA	45100w	22314 GMEX	45100b	22324 VS C4 F80	45100f
22216 CA	45100c	22244 GMEX	45100w	22314 MB	45100b	22326 C	45100h
22216 GMEX	45100c	22244 MB	45100w	22314 VS C4 F80	45100b	22326 C 2RS	45100h
22216 MB	45100c	22248 CA	45100x	22315 C	45100b	22326 CA	45100h



Deep Groove Ball Bearing	Self-Aligning Ball Bearing	Angular Contact Ball Bearing	
Cylindrical Roller Bearing	Tapered Roller Bearing	Spherical Roller Bearing	
Thrust Ball Bearing	Spherical Roller Thrust Bearing	Accessories Adapter & Withdrawal Sleeve	Technical & Related Information

# 95100e

## Page codes index

Item description	Page code	Item description	Page code	Item description	Page code	Item description	Page code
22326 GMEX	45100h	230/1180 CA	45101f	23044 MB	45100w	23124 CA	45100f
22326 MA C4 F80	45100h	230/1250 CA	45101f	23048 CA	45100x	23124 GMEX	45100f
22326 MB	45100h	230/500 CA	45101c	23048 GMEX	45100x	23124 MB	45100f
22326 VS C4 F80	45100h	230/500 MB	45101c	23048 MB	45100x	23126 C	45100h
22328 C	45100m	230/530 CA	45101d	2305 2RS	25100a	23126 CA	45100h
22328 C 2RS	45100m	230/560 CA	45101d	23052 C	45100x	23126 GMEX	45100h
22328 CA	45100m	230/600 CA	45101d	23052 CA	45100x	23126 MB	45100h
22328 GMEX	45100m	230/600 MB	45101d	23052 GMEX	45100x	23128 C	45100m
22328 MA C4 F80	45100m	230/630 CA	45101d	23052 MB	45100x	23128 CA	45100m
22328 MB	45100m	230/670 CA	45101d	23056 C	45100z	23128 GMEX	45100m
22328 VS C4 F80	45100m	230/710 CA	45101e	23056 CA	45100z	23128 MB	45100m
22330 C	45100n	230/750 CA	45101e	23056 GMEX	45100z	23130 CA	45100n
22330 C 2RS	45100n	230/800 CA	45101e	23056 MB	45100z	23130 GMEX	45100n
22330 CA	45100n	230/800 MB	45101e	2306 2RS	25100a	23130 MB	45100n
22330 GMEX	45100n	230/850 CA	45101e	23060 CA	45100z	23132 C	45100r
22330 MA C4 F80	45100n	230/900 CA	45101e	23060 MB	45100z	23132 CA	45100r
22330 MB	45100n	230/950 CA	45101e	23064 CA	45101a	23132 GMEX	45100r
22330 VS C4 F80	45100n	23020 CA	45100d	23064 MB	45101a	23132 MB	45100r
22332 C	45100r	23020 GMEX	45100d	23068 CA	45101a	23134 C	45100s
22332 CA	45100r	23022 CA	45100e	23068 MB	45101a	23134 CA	45100s
22332 GMEX	45100r	23022 GMEX	45100e	2307 2RS	25100a	23134 GMEX	45100s
22332 MA C4 F80	45100r	23022 MB	45100e	23072 CA	45101a	23134 MB	45100s
22332 MB	45100r	23024 C	45100e	23072 MB	45101a	23136 C	45100t
22332 VS C4 F80	45100r	23024 CA	45100f	23076 CA	45101b	23136 CA	45100t
22334 C	45100s	23024 GMEX	45100f	23076 MB	45101b	23136 GMEX	45100t
22334 CA	45100s	23024 MB	45100e	2308 2RS	25100a	23136 MB	45100t
22334 GMEX	45100s	23026 C	45100h	23080 CA	45101b	23138 C	45100u
22334 MA C4 F80	45100s	23026 CA	45100h	23080 MB	45100m	23138 CA	45100u
22334 MB	45100s	23026 GMEX	45100h	23080 MB	45101b	23138 GMEX	45100u
22334 VS C4 F80	45100s	23026 MB	45100h	23084 CA	45101b	23138 MB	45100u
22336 CA	45100t	23028 C	45100m	23084 MB	45101b	23140 CA	45100v
22336 GMEX	45100t	23028 CA	45100m	23088 CA	45101c	23140 GMEX	45100v
22336 MA C4 F80	45100t	23028 GMEX	45100m	2309 2RS	25100b	23144 CA	45100w
22336 MB	45100t	23030 C	45100n	23092 CA	45101c	23144 GMEX	45100w
22336 VS C4 F80	45100t	23030 CA	45100n	23092 MB	45101c	23144 MB	45100w
22338 CA	45100u	23030 GMEX	45100n	23096 CA	45101c	23148 CA	45100x
22338 GMEX	45100u	23030 MB	45100n	231/1000 CA	45101f	23148 GMEX	45100x
22338 MA C4 F80	45100u	23032 C	45100r	231/500 CA	45101c	23148 MB	45100x
22338 MB	45100u	23032 CA	45100r	231/530 CA	45101d	23152 CA	45100x
22340 CA	45100v	23032 GMEX	45100r	231/560 CA	45101d	23152 MB	45100x
22340 GMEX	45100v	23032 MB	45100r	231/600 CA	45101d	23156 CA	45100z
22340 MA C4 F80	45100v	23034 C	45100s	231/630 CA	45101d	23156 MB	45100z
22340 MB	45100v	23034 CA	45100s	231/670 CA	45101d	23160 CA	45100z
22344 C	45100w	23034 GMEX	45100s	231/710 CA	45101e	23160 MB	45100z
22344 CA	45100w	23034 MB	45100s	231/750 CA	45101e	23164 CA	45101a
22344 GMEX	45100w	23036 C	45100t	231/800 CA	45101e	23164 MB	45101a
22348 CA	45100x	23036 CA	45100t	231/850 CA	45101e	23168 CA	45101a
22348 MB	45100x	23036 GMEX	45100t	2310 2RS	25100b	23168 MB	45101a
22352 C	45100x	23036 MB	45100t	23111 MB	45100a	23172 CA	45101a
22352 CA	45100x	23038 C	45100u	23120 CA	45100d	23176 CA	45101b
22356 CA	45100z	23038 CA	45100u	23120 GMEX	45100d	23176 MB	45101b
22364 CA	45101a	23038 GMEX	45100u	23120 MB	45100d	23180 CA	45101b
22372 CA	45101a	23038 MB	45100u	23121 CA	45100d	23180 MB	45101b
22380 CA	45101b	23040 CA	45100v	23121 GMEX	45100d	23184 CA	45101b
22380 MB	45101b	23040 GMEX	45100v	23122 C	45100e	23188 CA	45101c
230/1000 CA	45101f	23044 C	45100w	23122 CA	45100e	23192 CA	45101c
230/1060 CA	45101f	23044 CA	45100w	23122 GMEX	45100e	23196 CA	45101c
230/1120 CA	45101f	23044 GMEX	45100w	23122 MB	45100e	232/500 CA	45101c



Deep Groove Ball Bearing	Self-Aligning Ball Bearing	Angular Contact Ball Bearing	
Cylindrical Roller Bearing	Tapered Roller Bearing	Spherical Roller Bearing	
Thrust Ball Bearing	Spherical Roller Thrust Bearing	Accessories Adapter & Withdrawal Sleeve	Technical & Related Information

## 95100f

## Page codes index

Item description	Page code	Item description	Page code	Item description	Page code	Item description	Page code
232/530 CA	45101d	23256 MB	45100z	23944 CA	45100w	24034 CA	45100s
232/560 CA	45101d	23260 CA	45100z	23944 MB	45100w	24034 GMEX	45100s
232/600 CA	45101d	23260 MB	45100z	23948 CA	45100x	24034 MB	45100s
232/670 CA	45101d	23264 CA	45101a	23948 MB	45100x	24036 CA	45100t
232/710 CA	45101e	23264 MB	45101a	23952 CA	45100x	24036 GMEX	45100t
232/750 CA	45101e	23268 CA	45101a	23952 MB	45100x	24036 MB	45100t
23218 CA	45100c	23272 CA	45101a	23956 C	45100z	24038 CA	45100u
23218 GMEX	45100c	23276 CA	45101b	23956 CA	45100z	24038 GMEX	45100u
23218 MB	45100c	23276 MB	45101b	23960 CA	45100z	24038 MB	45100u
23220 C	45100d	23280 CA	45101b	23960 MB	45100z	24040 CA	45100v
23220 CA	45100d	23284 CA	45101b	23964 CA	45101a	24040 GMEX	45100v
23220 GMEX	45100d	23284 MB	45101b	23964 MB	45101a	24044 CA	45100w
23220 MB	45100d	23288 CA	45101c	23968 CA	45101a	24044 GMEX	45100w
23222 C	45100e	23289 CA	45101c	23968 MB	45101a	24044 MB	45100w
23222 CA	45100e	23292 CA	45101c	23972 CA	45101a	24048 CA	45100x
23222 GMEX	45100e	23296 CA	45101c	23972 MB	45101a	24048 GMEX	45100x
23222 MB	45100e	23328 CA	45100m	23976 CA	45101b	24052 CA	45100x
23224 C	45100f	23328 MA C4 F80	45100m	23980 CA	45101b	24052 GMEX	45100x
23224 CA	45100f	23332 MA C4 F80	45100r	23984 CA	45101b	24052 MB	45100x
23224 GMEX	45100f	23332 VS C4 F80	45100r	23988 CA	45101c	24056 CA	45100z
23224 MB	45100f	23340 CA	45100v	23992 CA	45101c	24056 MB	45100z
23226 C	45100h	23772 MB	45101a	23996 CA	45101c	24060 CA	45100z
23226 CA	45100h	238/1000 CA	45101f	23996 MB	45101c	24064 CA	45101a
23226 GMEX	45100h	238/1060 CA	45101f	240/1000 CA	45101f	24068 CA	45101a
23226 MB	45100h	238/1180 CA	45101f	240/1060 CA	45101f	24072 CA	45101a
23228 CA	45100m	238/500 CA	45101c	240/1120 CA	45101f	24076 CA	45101b
23228 GMEX	45100m	238/530 CA	45101d	240/1320 CA	45101f	24080 CA	45101b
23228 MB	45100m	238/630 CA	45101d	240/500 CA	45101c	24080 MB	45100m
23230 CA	45100n	238/670 CA	45101d	240/530 CA	45101d	24084 CA	45101b
23230 GMEX	45100n	238/710 CA	45101e	240/560 CA	45101d	24088 CA	45101c
23230 MB	45100n	238/750 CA	45101e	240/600 CA	45101d	24088 MB	45101c
23232 CA	45100r	238/850 CA	45101e	240/670 CA	45101d	24092 CA	45101c
23232 GMEX	45100r	23856 CA	45100z	240/710 CA	45101e	24096 CA	45101c
23232 MB	45100r	23860 CA	45100z	240/750 CA	45101e	241/1000 CA	45101f
23234 C	45100s	23864 CA	45101a	240/800 CA	45101e	241/500 CA	45101c
23234 CA	45100s	23884 CA	45101b	240/850 CA	45101e	241/530 CA	45101d
23234 GMEX	45100s	23896 CA	45101c	240/900 CA	45101e	241/560 CA	45101d
23234 MB	45100s	239/1060 CA	45101f	240/950 CA	45101e	241/600 CA	45101d
23236 CA	45100t	239/1180 CA	45101f	240/950 CAF	45101e	241/630 CA	45101d
23236 GMEX	45100t	239/500 CA	45101c	24018 CA	45100c	241/670 CA	45101d
23236 MB	45100t	239/530 CA	45101d	24020 CA	45100d	241/710 CA	45101e
23238 C	45100u	239/560 CA	45101d	24020 GMEX	45100d	241/750 CA	45101e
23238 CA	45100u	239/600 CA	45101d	24022 CA	45100e	241/800 CA	45101e
23238 GMEX	45100u	239/630 CA	45101d	24022 GMEX	45100e	241/850 CA	45101e
23238 MB	45100u	239/670 CA	45101d	24024 CA	45100f	241/900 CA	45101e
23240 CA	45100v	239/710 CA	45101e	24024 GMEX	45100f	241/950 CA	45101e
23240 GMEX	45100v	239/750 CA	45101e	24024 MB	45100f	24122 CA	45100e
23240 MB	45100v	239/800 CA	45101e	24026 CA	45100h	24122 GMEX	45100e
23244 C	45100w	239/800 MB	45101e	24026 GMEX	45100h	24124 CA	45100f
23244 CA	45100w	239/850 CA	45101e	24026 MB	45100h	24124 GMEX	45100f
23244 GMEX	45100w	239/900 CA	45101e	24028 CA	45100m	24124 MB	45100f
23244 MB	45100w	239/950 CA	45101e	24028 GMEX	45100m	24126 CA	45100h
23248 CA	45100x	239/950 CAF	45101e	24030 CA	45100n	24126 GMEX	45100h
23248 GMEX	45100x	23936 CA	45100t	24030 GMEX	45100n	24126 MB	45100h
23248 MB	45100x	23938 CA	45100u	24030 MB	45100n	24128 CA	45100m
23252 CA	45100x	23940 CA	45100v	24032 CA	45100r	24128 GMEX	45100m
23252 MB	45100x	23940 MB	45100v	24032 GMEX	45100r	24128 MB	45100m
23256 CA	45100z	23944 C	45100w	24032 MB	45100r	24130 C	45100n

7821606595  
7821604051  
7821610766





Deep Groove Ball Bearing	Self-Aligning Ball Bearing	Angular Contact Ball Bearing	
Cylindrical Roller Bearing	Tapered Roller Bearing	Spherical Roller Bearing	
Thrust Ball Bearing	Spherical Roller Thrust Bearing	Accessories Adapter & Withdrawal Sleeve	Technical & Related Information

# 95100h

## Page codes index

Item description	Page code	Item description	Page code	Item description	Page code	Item description	Page code
24130 CA	45100n	249/750 CA	45101e	29348 EM	55100a	306/680	40100e
24130 GMEX	45100n	249/800 CA	45101e	29352 EM	55100a	31305 A	40100a
24132 C	45100r	249/850 CA	45101e	29356 EM	55100a	319/710	40100e
24132 CA	45100r	249/950 CA	45101e	29360 EM	55100a	32026 X	40100d
24132 GMEX	45100r	2650C CA	45100x	29364 EM	55100a	3203 2RS	30100b
24134 C	45100s	292/500 EM	55100b	29368 EM	55100b	32236 A	40100e
24134 CA	45100s	292/530 EM	55100b	29372 EM	55100b	32318 A	40100c
24134 GMEX	45100s	292/560 EM	55100b	29376 EM	55100b	32328 A	40100d
24136 C	45100t	292/600 EM	55100b	29380 EM	55100b	32332 A	40100d
24136 CA	45100t	292/630 EM	55100b	29384 EM	55100b	329/630	40100e
24136 GMEX	45100t	292/670 EM	55100b	29388 EM	55100b	3308 2RS	30100b
24138 CA	45100u	292/710 EM	55100b	29392 EM	55100b	51126 M	50100b
24138 GMEX	45100u	292/750 EM	55100b	29396 EM	55100b	51128 M	50100b
24138 MB	45100u	292/800 EM	55100b	294/500 EM	55100b	51130 M	50100b
24140 CA	45100v	292/850 EM	55100b	294/530 EM	55100b	51132 M	50100b
24140 GMEX	45100v	292/900 EM	55100b	294/560 EM	55100b	51134 M	50100b
24140 MB	45100v	292/950 EM	55100b	294/600 EM	55100b	51136 M	50100b
24144 CA	45100w	29234 EM	55100a	294/630 EM	55100b	51138 M	50100b
24144 MB	45100w	29236 EM	55100a	294/710 EM	55100b	51140 M	50100b
24148 CA	45100x	29238 EM	55100a	294/750 EM	55100b	51144 M	50100b
24148 GMEX	45100x	29240 EM	55100a	294/850 EM	55100b	51148 M	50100b
24148 MB	45100x	29244 EM	55100a	29412 EM	55100a	51152 M	50100b
24152 CA	45100x	29248 EM	55100a	29413 EM	55100a	51156 M	50100b
24156 CA	45100z	29252 EM	55100a	29414 EM	55100a	51160 M	50100b
24156 MB	45100z	29256 EM	55100a	29415 EM	55100a	51164 M	50100b
24160 CA	45100z	29260 EM	55100a	29416 EM	55100a	51224M	50100b
24164 CA	45101a	29264 EM	55100a	29417 EM	55100a	51226 M	50100b
24166 CA	45101a	29268 EM	55100b	29418 EM	55100a	51228 M	50100b
24168 CA	45101a	29272 EM	55100b	29420 EM	55100a	51230 M	50100b
24168 MB	45101a	29276 EM	55100b	29422 EM	55100a	51232 M	50100b
24172 CA	45101a	29280 EM	55100b	29424 EM	55100a	51234 M	50100b
24176 CA	45101b	29284 EM	55100b	29426 EM	55100a	51236 M	50100b
24180 CA	45101b	29288 EM	55100b	29428 EM	55100a	51238 M	50100b
24184 CA	45101b	29292 EM	55100b	29430 EM	55100a	51240 M	50100b
24188 CA	45101c	29296 EM	55100b	29432 EM	55100a	51244 M	50100b
24192 CA	45101c	293/500 EM	55100b	29434 EM	55100a	51248 M	50100b
24196 CA	45101c	293/530 EM	55100b	29436 EM	55100a	51252 M	50100b
24218 CA	45100c	293/560 EM	55100b	29438 EM	55100a	51256 M	50100b
24712 CA	45101a	293/600 EM	55100b	29440 EM	55100a	51260 M	50100b
248/1060 CA	45101f	293/630 EM	55100b	29444 EM	55100a	51324 M	50100b
248/1120 CA	45101f	293/670 EM	55100b	29448 EM	55100a	51330 M	50100b
248/1180 CA	45101f	293/710 EM	55100b	29452 EM	55100a	51334 M	50100b
248/1320 CA	45101f	293/750 EM	55100b	29456 EM	55100a	51336 M	50100b
248/1500 CA	45101f	293/800 EM	55100b	29460 EM	55100a	51338 M	50100b
248/1800 CA	45101f	29317 EM	55100a	29464 EM	55100a	51430 M	50100b
248/530 CA	45101d	29318 EM	55100a	29468 EM	55100b	52228M	50100c
248/670 CA	45101d	29320 EM	55100a	29472 EM	55100b	52230M	50100c
248/800 CA	45101e	29322 EM	55100a	29476 EM	55100b	52232M	50100c
248/900 CA	45101e	29324 EM	55100a	29480 EM	55100b	52234M	50100c
24892 CA	45101c	29326 EM	55100a	29484 EM	55100b	52330M	50100c
249/1000 CA	45101f	29328 EM	55100a	29488 EM	55100b	60/1000	20100s
249/1060 CA	45101f	29330 EM	55100a	29492 EM	55100b	60/1060	20100s
249/1120 CA	45101f	29332 EM	55100a	29496 EM	55100b	60/1120	20100s
249/1180 CA	45101f	29334 EM	55100a	30228 A	40100d	60/500	20100r
249/1320 CA	45101f	29336 EM	55100a	30328 A	40100d	60/530	20100r
249/1400 CA	45101f	29338 EM	55100a	306/1000	40100e	60/630	20100r
249/600 CA	45101d	29340 EM	55100a	306/560	40100e	60/710	20100r
249/710 CA	45101e	29344 EM	55100a	306/630	40100e	60/750	20100r

7821606595  
7821604051  
7821610766





Deep Groove Ball Bearing	Self-Aligning Ball Bearing	Angular Contact Ball Bearing	
Cylindrical Roller Bearing	Tapered Roller Bearing	Spherical Roller Bearing	
Thrust Ball Bearing	Spherical Roller Thrust Bearing	Accessories Adapter & Withdrawal Sleeve	Technical & Related Information

# 95100k

## Page codes index

Item description	Page code	Item description	Page code	Item description	Page code	Item description	Page code
60/800	20100r	6052 M	20100n	619/1060	20100s	6211 ZZ	20100e
60/850	20100r	607 2RS	20100a	619/1120	20100s	6212 2RS	20100f
60/900	20100s	607 ZZ	20100a	619/1180	20100s	6212 ZZ	20100f
60/950	20100s	6072 M	20100n	619/1400	20100s	6213 2RS	20100f
6000 2RS	20100b	608 2RS	20100a	619/1500	20100s	6213 ZZ	20100f
6000 ZZ	20100b	608 ZZ	20100a	619/1600	20100s	6214 2RS	20100f
6001 2RS	20100b	608/1000 M	20100s	619/500	20100r	6214 ZZ	20100f
6001 ZZ	20100b	608/500	20100r	619/630	20100r	6215 2RS	20100h
6002 2RS	20100b	608/560	20100r	619/670 M	20100r	6215 ZZ	20100h
6002 ZZ	20100b	608/600	20100r	619/710	20100r	6216 2RS	20100h
6003 2RS	20100c	608/630	20100r	619/750	20100r	6216 ZZ	20100h
6003 ZZ	20100c	608/800	20100r	619/800	20100r	6217 2RS	20100h
6004 2RS	20100c	608/850	20100r	619/850	20100r	6217 ZZ	20100h
6004 ZZ	20100c	6080 M	20100r	619/900	20100s	6218 2RS	20100h
6005 2RS	20100c	609 2RS	20100a	619/950	20100s	6218 ZZ	20100h
6005 ZZ	20100c	609 ZZ	20100a	61900 ZZ	20100b	6219 ZZ	20100k
6006 2RS	20100d	609/1000	20100s	61901 ZZ	20100b	6220 2RS	20100k
6006 ZZ	20100d	609/1320	20100s	61902 ZZ	20100b	6220 ZZ	20100k
6007 2RS	20100d	609/530	20100r	61903 ZZ	20100c	62206 2RS	20100d
6008 2RS	20100d	609/630	20100r	61904 ZZ	20100c	6222 ZZ	20100k
6008 ZZ	20100d	609/670	20100r	61905 ZZ	20100c	6224 ZZ	20100k
6009 2RS	20100e	609/710	20100r	61914 2RS	20100f	6228 M	20100m
6009 ZZ	20100e	618/1000 M	20100s	61926 M	20100m	623 ZZ	20100a
6010 2RS	20100e	618/1060	20100s	61930 M	20100m	62332M	50100c
6010 ZZ	20100e	618/1120	20100s	61932 M	20100m	6234 M	20100m
6011 2RS	20100e	618/1250	20100s	61934 M	20100m	624 ZZ	20100a
6011 ZZ	20100e	618/1400	20100s	61940 M	20100n	6240 M	20100n
6012 2RS	20100f	618/1500	20100s	61944 M	20100n	625 ZZ	20100a
6012 ZZ	20100f	618/1600	20100s	61948 M	20100n	626 2RS	20100a
6013 2RS	20100f	618/1700	20100s	61952 M	20100n	626 ZZ	20100a
6013 ZZ	20100f	618/500 M	20100r	61956 M	20100n	628 2RS	20100a
6014 2RS	20100f	618/560 M	20100r	61968 M	20100n	628 ZZ	20100a
6014 ZZ	20100f	618/600	20100r	61972 M	20100n	628/6 ZZ	20100a
6015 2RS	20100h	618/670	20100r	61984 M	20100r	628/7 ZZ	20100a
6015 ZZ	20100h	618/710	20100r	61988 M	20100r	629 2RS	20100a
6016 2RS	20100h	618/750	20100r	6200 2RS	20100b	629 ZZ	20100a
6016 ZZ	20100h	618/800	20100r	6200 ZZ	20100b	6300 2RS	20100b
6017 2RS	20100h	618/850	20100r	6201 2RS	20100b	6300 ZZ	20100b
6017 ZZ	20100h	618/900 CA	20100s	6201 ZZ	20100b	6301 2RS	20100b
6018 2RS	20100h	61800 ZZ	20100b	6202 2RS	20100b	6301 ZZ	20100b
6018 ZZ	20100h	61801 ZZ	20100b	6202 ZZ	20100b	6302 2RS	20100b
6019 2RS	20100k	61802 ZZ	20100b	6203 2RS	20100c	6302 ZZ	20100b
6019 ZZ	20100k	61803 ZZ	20100c	6203 ZZ	20100c	6303 2RS	20100c
6020 2RS	20100k	61804 ZZ	20100c	6204 2RS	20100c	6303 ZZ	20100c
6020 ZZ	20100k	61805 ZZ	20100c	6204 ZZ	20100c	6304 2RS	20100c
6021 ZZ	20100k	61840 M	20100n	6205 2RS	20100c	6304 ZZ	20100c
6022 ZZ	20100k	61844 M	20100n	6205 ZZ	20100c	6305 2RS	20100c
6024 2RS	20100k	61848 M	20100n	6206 2RS	20100d	6305 ZZ	20100c
6024 ZZ	20100k	61852 M	20100n	6206 ZZ	20100d	6306 2RS	20100d
6026 ZZ	20100m	61856 M	20100n	6207 2RS	20100d	6306 ZZ	20100d
6028 ZZ	20100m	61860 M	20100n	6207 ZZ	20100d	6307 2RS	20100d
6030 2RS	20100m	61864 M	20100n	6208 2RS	20100d	6307 ZZ	20100d
6030 ZZ	20100m	61868 M	20100n	6208 ZZ	20100d	6308 2RS	20100d
6032 ZZ	20100m	61872 M	20100n	6209 2RS	20100e	6308 ZZ	20100d
6036 M	20100m	61876 MA	20100r	6209 ZZ	20100e	6309 2RS	20100e
6040 M	20100n	61888 M	20100r	6210 2RS	20100e	6309 ZZ	20100e
6044 M	20100n	61892 M	20100r	6210 ZZ	20100e	6310 2RS	20100e
6048 M	20100n	619/1000	20100s	6211 2RS	20100e	6310 ZZ	20100e

7821606595  
7821604051  
7821610766



Deep Groove Ball Bearing	Self-Aligning Ball Bearing	Angular Contact Ball Bearing	
Cylindrical Roller Bearing	Tapered Roller Bearing	Spherical Roller Bearing	
Thrust Ball Bearing	Spherical Roller Thrust Bearing	Accessories Adapter & Withdrawal Sleeve	Technical & Related Information

## 95100m

## Page codes index

Item description	Page code	Item description	Page code	Item description	Page code	Item description	Page code
6311 2RS	20100e	7309 B	30100a	AH 2352	60200d	AH 3044	60200c
6311 ZZ	20100e	7310 B	30100a	AH 2352 OH	60200d	AH 3044 OH	60200c
6312 2RS	20100f	7311 B	30100a	AH 2356	60200d	AH 3048	60200c
6312 ZZ	20100f	7312 B	30100a	AH 2356 OH	60200d	AH 3048 OH	60200c
6313 2RS	20100f	7313 B	30100a	AH 24024	60200a	AH 3052	60200d
6313 ZZ	20100f	7314 B	30100a	AH 24026	60200a	AH 3052 H	60200d
6314 2RS	20100f	7315 B	30100a	AH 24028	60200a	AH 3052 OH	60200d
6314 ZZ	20100f	7316 B	30100a	AH 24030	60200a	AH 3056	60200d
6315 2RS	20100h	7317 B	30100a	AH 24032	60200b	AH 3056 OH	60200d
6315 ZZ	20100h	7318 B	30100a	AH 24034	60200b	AH 3060	60200d
6316 ZZ	20100h	7319 B	30100a	AH 24036	60200b	AH 3060 OH	60200d
6317 ZZ	20100h	7320 B	30100a	AH 24038	60200b	AH 3064	60200d
6318 ZZ	20100h	7322 B	30100a	AH 24040	60200b	AH 3064 OH	60200d
6320 ZZ	20100k	7328 B	30100a	AH 24122	60200a	AH 3068	60200d
6322 M	20100k	AH 2236	60200b	AH 24124	60200a	AH 3068 OH	60200d
6328 M	20100m	AH 2238	60200b	AH 24126	60200a	AH 3072	60200e
6332 M	20100m	AH 2240	60200b	AH 24128	60200a	AH 3072 OH	60200e
634 ZZ	20100a	AH 2244	60200c	AH 24130	60200a	AH 3076	60200e
635 ZZ	20100a	AH 2248	60200c	AH 24132	60200b	AH 3076 OH	60200e
636 2RS	20100a	AH 2248 OH	60200c	AH 24134	60200b	AH 308	60200a
636 ZZ	20100a	AH 2252	60200d	AH 24136	60200b	AH 3080	60200e
637 2RS	20100a	AH 2252 OH	60200d	AH 24138	60200b	AH 3080 OH	60200e
637 ZZ	20100a	AH 2256	60200d	AH 24140 OH	60200b	AH 3084	60200e
638 ZZ	20100a	AH 2256 OH	60200d	AH 24144 OH	60200c	AH 3084 OH	60200e
639 ZZ	20100a	AH 2260	60200d	AH 24156 OH	60200d	AH 3088	60200e
6646 M	20100n	AH 2260 OH	60200d	AH 24168 OH	60200d	AH 3088 OH	60200e
7005 B	30100a	AH 2264	60200d	AH 24172 OH	60200e	AH 309	60200a
7005 B 2RSR	30100a	AH 2264 OH	60200d	AH 30/500	60200f	AH 3092	60200e
7200 B	30100a	AH 2308	60200a	AH 30/500 OH	60200f	AH 3092 OH	60200e
7201 B	30100a	AH 2309	60200a	AH 30/530	60200f	AH 3096	60200e
7202 B	30100a	AH 2310	60200a	AH 30/530 OH	60200f	AH 3096 OH	60200e
7203 B	30100a	AH 2311	60200a	AH 30/560	60200f	AH 31/500	60200f
7203 B TN	30100a	AH 2312	60200a	AH 30/560 OH	60200f	AH 31/500 OH	60200f
7204 B	30100a	AH 2313	60200a	AH 30/600	60200f	AH 31/530	60200f
7205 B	30100a	AH 2314	60200a	AH 30/600 OH	60200f	AH 31/560	60200f
7206 B	30100a	AH 2315	60200a	AH 30/630	60200f	AH 31/630	60200f
7207 B	30100a	AH 2316	60200a	AH 30/630 OH	60200f	AH 31/750	60200f
7208 B	30100a	AH 2317	60200a	AH 30/670	60200f	AH 31/800	60200f
7209 B	30100a	AH 2318	60200a	AH 30/670 OH	60200f	AH 31/850	60200f
7210 B	30100a	AH 2319	60200a	AH 30/710	60200f	AH 31/900	60200f
7211 B	30100a	AH 2320	60200a	AH 30/710 OH	60200f	AH 31/950	60200f
7212 B	30100a	AH 2322	60200a	AH 30/750	60200f	AH 310	60200a
7213 B	30100a	AH 2324	60200a	AH 30/800	60200f	AH 311	60200a
7214 B	30100a	AH 2326	60200a	AH 30/850	60200f	AH 312	60200a
7215 B	30100a	AH 2328	60200a	AH 30/900	60200f	AH 3122	60200a
7216 B	30100a	AH 2330	60200a	AH 30/950	60200f	AH 3124	60200a
7217 B	30100a	AH 2332	60200b	AH 3024	60200a	AH 3126	60200a
7218 B	30100a	AH 2334	60200b	AH 3026	60200a	AH 3128	60200a
7219 B	30100a	AH 2336	60200b	AH 3028	60200a	AH 313	60200a
7220 B	30100a	AH 2336 OH	60200b	AH 3030	60200a	AH 3130	60200a
7222 B	30100a	AH 2338	60200b	AH 3032	60200b	AH 3132	60200b
7302 B	30100a	AH 2338 OH	60200b	AH 3034	60200b	AH 3134	60200b
7303 B	30100a	AH 2340	60200b	AH 3036	60200b	AH 3136	60200b
7304 B	30100a	AH 2340 OH	60200b	AH 3036 OH	60200b	AH 3136 OH	60200b
7305 B	30100a	AH 2344	60200c	AH 3038	60200b	AH 3138	60200b
7306 B	30100a	AH 2344 OH	60200c	AH 3038 OH	60200b	AH 3138 OH	60200b
7307 B	30100a	AH 2348	60200c	AH 3040	60200b	AH 314	60200a
7308 B	30100a	AH 2348 OH	60200c	AH 3040 OH	60200b	AH 3140	60200b

7821606595  
7821604051  
7821610766





Deep Groove Ball Bearing	Self-Aligning Ball Bearing	Angular Contact Ball Bearing	
Cylindrical Roller Bearing	Tapered Roller Bearing	Spherical Roller Bearing	
Thrust Ball Bearing	Spherical Roller Thrust Bearing	Accessories Adapter & Withdrawal Sleeve	Technical & Related Information

# 95100n

## Page codes index

Item description	Page code	Item description	Page code	Item description	Page code	Item description	Page code
AH 3140 OH	60200b	AH 3268	60200d	H 2328	60100b	H 3060	60100d
AH 3144	60200c	AH 3268 OH	60200d	H 2330	60100b	H 3060 OH	60100d
AH 3144 OH	60200c	AH 3272	60200e	H 2332	60100b	H 3064	60100d
AH 3148	60200c	AH 3272 OH	60200e	H 2334	60100b	H 3064 OH	60100d
AH 3148 OH	60200c	AH 3276	60200e	H 2336	60100b	H 3068	60100d
AH 315	60200a	AH 3276 OH	60200e	H 2336 OH	60100b	H 3068 OH	60100d
AH 3152	60200d	AH 3280	60200e	H 2338	60100b	H 307	60100a
AH 3152 OH	60200d	AH 3280 OH	60200e	H 2338 OH	60100b	H 3072	60100e
AH 3156	60200d	AH 3284	60200e	H 2340	60100b	H 3072 OH	60100e
AH 3156 OH	60200d	AH 3284 OH	60200e	H 2340 OH	60100b	H 3076	60100e
AH 316	60200a	AH 3288	60200e	H 2344	60100c	H 3076 OH	60100e
AH 3160	60200d	AH 3288 OH	60200e	H 2344 OH	60100c	H 308	60100a
AH 3160 OH	60200d	AH 3292	60200e	H 2348	60100c	H 3080	60100e
AH 3164	60200d	AH 3292 OH	60200e	H 2348 OH	60100c	H 3080 OH	60100e
AH 3164 OH	60200d	AH 3296	60200e	H 2352	60100d	H 3084	60100e
AH 3168	60200d	AH 3296 OH	60200e	H 2352 OH	60100d	H 3084 OH	60100e
AH 3168 OH	60200d	AH 3940	60200b	H 2356	60100d	H 3088	60100e
AH 317	60200a	AH 3952 G	60200d	H 2356 OH	60100d	H 3088 OH	60100e
AH 3172	60200e	AH 3996 OH	60200e	H 30/500	60100f	H 309	60100a
AH 3172 OH	60200e	H 204	60100a	H 30/500 OH	60100f	H 3092	60100e
AH 3176	60200e	H 205	60100a	H 30/530	60100f	H 3092 OH	60100e
AH 3176 OH	60200e	H 206	60100a	H 30/530 OH	60100f	H 3096	60100e
AH 318	60200a	H 207	60100a	H 30/560	60100f	H 3096 OH	60100e
AH 3180	60200e	H 208	60100a	H 30/560 OH	60100f	H 31/500	60100f
AH 3180 OH	60200e	H 209	60100a	H 30/600	60100f	H 31/500 OH	60100f
AH 3184	60200e	H 210	60100a	H 30/600 OH	60100f	H 31/530	60100f
AH 3184 OH	60200e	H 211	60100a	H 30/630	60100f	H 31/560	60100f
AH 3188	60200e	H 212	60100a	H 30/630 OH	60100f	H 31/600	60100f
AH 3188 OH	60200e	H 213	60100a	H 30/670	60100f	H 31/630	60100f
AH 319	60200a	H 214	60100a	H 30/670 OH	60100f	H 31/670	60100f
AH 3192	60200e	H 215	60100a	H 30/710	60100f	H 31/710	60100f
AH 3192 OH	60200e	H 216	60100a	H 30/710 OH	60100f	H 31/750	60100f
AH 3196	60200e	H 217	60100a	H 30/750	60100f	H 31/800	60100f
AH 3196 OH	60200e	H 218	60100a	H 30/800	60100f	H 310	60100a
AH 32/530	60200f	H 219	60100a	H 30/900 OH	60100f	H 311	60100a
AH 32/630	60200f	H 220	60100b	H 3024	60100b	H 312	60100a
AH 32/670	60200f	H 221	60100b	H 3026	60100b	H 3120	60100b
AH 32/710	60200f	H 222	60100b	H 3028	60100b	H 3122	60100b
AH 32/750	60200f	H 2304	60100a	H 3030	60100b	H 3124	60100b
AH 32/800	60200f	H 2305	60100a	H 3032	60100b	H 3126	60100b
AH 32/850	60200f	H 2306	60100a	H 3034	60100b	H 3128	60100b
AH 32/900	60200f	H 2307	60100a	H 3036	60100b	H 313	60100a
AH 32/900	60200f	H 2308	60100a	H 3036 OH	60100b	H 3130	60100b
AH 32/950	60200f	H 2309	60100a	H 3038	60100b	H 3132	60100b
AH 320	60200a	H 2310	60100a	H 3038 OH	60100b	H 3134	60100b
AH 322	60200a	H 2311	60100a	H 304	60100a	H 3136	60100b
AH 3232	60200b	H 2312	60100a	H 3040	60100b	H 3136 OH	60100b
AH 3234	60200b	H 2313	60100a	H 3040 OH	60100b	H 3138	60100b
AH 3236	60200b	H 2314	60100a	H 3044	60100c	H 3138 OH	60100b
AH 3236 OH	60200b	H 2315	60100a	H 3044 OH	60100c	H 314	60100a
AH 3238	60200b	H 2316	60100a	H 3048	60100c	H 3140	60100b
AH 3238 OH	60200b	H 2317	60100a	H 3048 OH	60100c	H 3140 OH	60100b
AH 3240	60200b	H 2318	60100a	H 305	60100a	H 3144	60100c
AH 3240 OH	60200b	H 2319	60100a	H 3052	60100d	H 3144 OH	60100c
AH 3260	60200d	H 2320	60100b	H 3052 OH	60100d	H 3148	60100c
AH 3260 OH	60200d	H 2322	60100b	H 3056	60100d	H 3148 OH	60100c
AH 3264	60200d	H 2324	60100b	H 3056 OH	60100d	H 315	60100a
AH 3264 OH	60200d	H 2326	60100b	H 306	60100a	H 3152	60100d



Deep Groove Ball Bearing	Self-Aligning Ball Bearing	Angular Contact Ball Bearing	
Cylindrical Roller Bearing	Tapered Roller Bearing	Spherical Roller Bearing	
Thrust Ball Bearing	Spherical Roller Thrust Bearing	Accessories Adapter & Withdrawal Sleeve	Technical & Related Information

# 95100r

## Page codes index

Item description	Page code	Item description	Page code	Item description	Page code	Item description	Page code
H 3152 OH	60100d	H 3296	60100e	KM 3	60250b	MB 33	60250a
H 3156	60100d	H 3296 OH	60100e	KM 30	60250b	MB 34	60250a
H 3156 OH	60100d	H 39/500	60100f	KM 31	60250b	MB 36	60250a
H 316	60100a	H 39/530	60100f	KM 32	60250b	MB 38	60250a
H 3160	60100d	H 39/530 OH	60100f	KM 33	60250b	MB 4	60250a
H 3160 OH	60100d	H 39/560	60100f	KM 34	60250b	MB 40	60250a
H 3164	60100d	H 39/560 OH	60100f	KM 36	60250b	MB 44	60250a
H 3164 OH	60100d	H 39/600	60100f	KM 38	60250b	MB 48	60250a
H 3168	60100d	H 39/600 OH	60100f	KM 4	60250b	MB 5	60250a
H 3168 OH	60100d	H 39/630	60100f	KM 40	60250b	MB 52	60250a
H 317	60100a	H 39/630 OH	60100f	KM 42	60250b	MB 56	60250a
H 3172	60100e	H 39/670	60100f	KM 44	60250b	MB 6	60250a
H 3172 OH	60100e	H 39/670 OH	60100f	KM 46	60250b	MB 7	60250a
H 3176	60100e	H 39/710	60100f	KM 48	60250b	MB 8	60250a
H 3176 OH	60100e	H 39/710 OH	60100f	KM 5	60250b	MB 9	60250a
H 318	60100a	H 39/750	60100f	KM 50	60250b	MBL 24	60250a
H 3180	60100e	H 39/800	60100f	KM 52	60250b	MBL 26	60250a
H 3180 OH	60100e	H 3936	60100b	KM 56	60250b	MBL 28	60250a
H 3184	60100e	H 3938	60100b	KM 6	60250b	MBL 30	60250a
H 3184 OH	60100e	H 3940	60100b	KM 7	60250b	MBL 32	60250a
H 3188	60100e	H 3944	60100c	KM 8	60250b	MBL 34	60250a
H 3188 OH	60100e	H 3948	60100c	KM 9	60250b	MBL 36	60250a
H 319	60100a	H 3952	60100d	KML 24	60250b	MBL 38	60250a
H 3192	60100e	H 3956	60100d	KML 26	60250b	MBL 40	60250a
H 3192 OH	60100e	H 3960	60100d	KML 28	60250b	N 1017 M	35200h
H 3196	60100e	H 3964	60100d	KML 30	60250b	N 1024 M	35300e
H 3196 OH	60100e	H 3968	60100d	KML 32	60250b	N 1036 M	35400b
H 32/500	60100f	H 3972	60100e	KML 34	60250b	N 1188	35400f
H 32/500 OH	60100f	H 3976	60100e	KML 36	60250b	N 18/1900	35400k
H 32/530	60100f	H 3980	60100e	KML 38	60250b	N 1892 M	35400f
H 32/560	60100f	H 3984	60100e	KML 40	60250b	N 20/1250 M	35400k
H 32/600	60100f	H 3988	60100e	MB 0	60250a	N 204	35100a
H 32/630	60100f	H 3992	60100e	MB 1	60250a	N 205	35100b
H 32/670	60100f	H 3996	60100e	MB 10	60250a	N 206 EM	35100c
H 32/710	60100f	HE 308	60100a	MB 11	60250a	N 207	35100d
H 32/750	60100f	KM 0	60250b	MB 12	60250a	N 208 EM	35100e
H 32/800	60100f	KM 1	60250b	MB 13	60250a	N 209 M	35100f
H 320	60100b	KM 10	60250b	MB 14	60250a	N 211 M	35200a
H 321	60100b	KM 11	60250b	MB 15	60250a	N 212 EM	35200b
H 322	60100b	KM 12	60250b	MB 16	60250a	N 213	35200c
H 3260	60100d	KM 13	60250b	MB 17	60250a	N 214 E	35200d
H 3260 OH	60100d	KM 14	60250b	MB 18	60250a	N 214 EM	35200d
H 3264	60100d	KM 15	60250b	MB 19	60250a	N 215 EM	35200e
H 3264 OH	60100d	KM 16	60250b	MB 2	60250a	N 216 E	35200f
H 3268	60100d	KM 17	60250b	MB 20	60250a	N 216 EM	35200f
H 3268 OH	60100d	KM 18	60250b	MB 21	60250a	N 217 M	35200h
H 3272	60100e	KM 19	60250b	MB 22	60250a	N 218 EM	35300a
H 3272 OH	60100e	KM 2	60250b	MB 23	60250a	N 218 M	35300a
H 3276	60100e	KM 20	60250b	MB 24	60250a	N 219	35300b
H 3276 OH	60100e	KM 21	60250b	MB 25	60250a	N 220 EM	35300c
H 3280	60100e	KM 22	60250b	MB 26	60250a	N 220 M	35300c
H 3280 OH	60100e	KM 23	60250b	MB 27	60250a	N 221 M	35300d
H 3284	60100e	KM 24	60250b	MB 28	60250a	N 222 M	35300d
H 3284 OH	60100e	KM 25	60250b	MB 29	60250a	N 2220 EM	35300c
H 3288	60100e	KM 26	60250b	MB 3	60250a	N 2222 EM	35300d
H 3288 OH	60100e	KM 27	60250b	MB 30	60250a	N 2234 M	35400b
H 3292	60100e	KM 28	60250b	MB 31	60250a	N 224 EM	35300e
H 3292 OH	60100e	KM 29	60250b	MB 32	60250a	N 224 M	35300e

7821606595  
7821604051  
7821610766







Deep Groove Ball Bearing	Self-Aligning Ball Bearing	Angular Contact Ball Bearing	
Cylindrical Roller Bearing	Tapered Roller Bearing	Spherical Roller Bearing	
Thrust Ball Bearing	Spherical Roller Thrust Bearing	Accessories Adapter & Withdrawal Sleeve	Technical & Related Information

# 95100s

## Page codes index

Item description	Page code	Item description	Page code	Item description	Page code	Item description	Page code
N 2252 M	35400d	N 332 EM	35400a	NCF 1884 V	35500d	NCF 2916 CV	35500a
N 226 EM	35300f	N 332 M	35400a	NCF 1884 CV	35500d	NCF 2917 CV	35500a
N 226 M	35300f	N 334 EM	35400b	NCF 1888 V	35500d	NCF 2918 CV	35500a
N 228 EM	35300h	N 336 M	35400b	NCF 1888 CV	35500d	NCF 2919 CV	35500b
N 230 EM	35400a	N 340 EM	35400c	NCF 1892 V	35500d	NCF 2920 CV	35500b
N 230 M	35400a	N 344 EM	35400d	NCF 1892 CV	35500d	NCF 2922 CV	35500b
N 2306	35100c	N 348 M	35400d	NCF 1896 V	35500d	NCF 2924 CV	35500b
N 2312	35200b	N 38/630 M	35400h	NCF 1896 CV	35500d	NCF 2926 CV	35500b
N 2316	35200f	N 39/1180 M	35400k	NCF 2204 CV	35500a	NCF 2928 CV	35500b
N 2319 M	35300b	N 39/1320 M	35400k	NCF 2205 CV	35500a	NCF 2930 V	35500b
N 232 EM	35400a	N 39/500 EM	35400h	NCF 2206 CV	35500a	NCF 2930 CV	35500b
N 2322 EM	35300d	N 408 M	35100e	NCF 2207 CV	35500a	NCF 2932 V	35500b
N 2322 M	35300d	N 409 M	35100f	NCF 2208 CV	35500a	NCF 2932 CV	35500b
N 234 EM	35400b	N 410 M	35100h	NCF 2209 CV	35500a	NCF 2934 V	35500b
N 236 EM	35400b	N 411	35200a	NCF 2210 CV	35500a	NCF 2934 CV	35500b
N 236 M	35400b	N 414 M	35200d	NCF 2211 CV	35500a	NCF 2936 V	35500b
N 238 EM	35400c	N 419 M	35300b	NCF 2212 CV	35500a	NCF 2936 CV	35500b
N 238 M	35400c	N 424 M	35300e	NCF 2213 CV	35500a	NCF 2938 V	35500b
N 240 EM	35400c	N 428 EM	35300h	NCF 2214 CV	35500a	NCF 2938 CV	35500b
N 240 M	35400c	N 6/820	35400k	NCF 2215 CV	35500a	NCF 2940 V	35500c
N 244 EM	35400d	NCF 18/1120 V	35500e	NCF 2216 CV	35500a	NCF 2940 CV	35500c
N 244 M	35400d	NCF 18/1400 V	35500e	NCF 2217 CV	35500a	NCF 2944 V	35500c
N 28/1060 M	35400k	NCF 18/500 V	35500e	NCF 2218 CV	35500a	NCF 2944 CV	35500c
N 28/1400 EM	35400k	NCF 18/500 CV	35500e	NCF 2219 CV	35500b	NCF 2948 V	35500c
N 28/630 M	35400h	NCF 18/530 V	35500e	NCF 2220 CV	35500b	NCF 2948 CV	35500c
N 28/710 EM	35400k	NCF 18/530 CV	35500e	NCF 2222 CV	35500b	NCF 2952 V	35500c
N 28/750	35400k	NCF 18/560 V	35500e	NCF 2224 CV	35500b	NCF 2952 CV	35500c
N 29/560	35400h	NCF 18/560 CV	35500e	NCF 2226 CV	35500b	NCF 2956 V	35500c
N 29/850 EM	35400k	NCF 18/600 V	35500e	NCF 2228 CV	35500b	NCF 2956 CV	35500c
N 30/1060	35400k	NCF 18/600 CV	35500e	NCF 2230 CV	35500b	NCF 2960 V	35500c
N 30/670	35400k	NCF 18/630 V	35500e	NCF 2234 CV	35500b	NCF 2960 CV	35500c
N 305 EM	35100b	NCF 18/630 CV	35500e	NCF 2236 CV	35500b	NCF 2964 V	35500c
N 307 E	35100d	NCF 18/670 V	35500e	NCF 2238 CV	35500b	NCF 2964 CV	35500c
N 307 EM	35100d	NCF 18/670 CV	35500e	NCF 2240 CV	35500c	NCF 2968 V	35500d
N 308	35100e	NCF 18/750 V	35500e	NCF 28/500 V	35500e	NCF 2968 CV	35500d
N 309 EM	35100f	NCF 18/800 V	35500e	NCF 28/530 V	35500e	NCF 2972 V	35500d
N 311	35200a	NCF 1840 V	35500c	NCF 28/560 V	35500e	NCF 2972 CV	35500d
N 312 M	35200b	NCF 1840 CV	35500c	NCF 28/750 V	35500e	NCF 2976 V	35500d
N 313 EM	35200c	NCF 1844 V	35500c	NCF 28/800 V	35500e	NCF 2976 CV	35500d
N 313 M	35200c	NCF 1844 CV	35500c	NCF 2896 V	35500d	NCF 2980 V	35500d
N 314 M	35200d	NCF 1848 V	35500c	NCF 29/1000 V	35500e	NCF 2980 CV	35500d
N 315 M	35200e	NCF 1848 CV	35500c	NCF 29/500 V	35500e	NCF 2984 V	35500d
N 316 M	35200f	NCF 1852 V	35500c	NCF 29/500 CV	35500e	NCF 2984 CV	35500d
N 317 M	35200h	NCF 1852 CV	35500c	NCF 29/530 V	35500e	NCF 2988 V	35500d
N 318 EM	35300a	NCF 1856 V	35500c	NCF 29/560 V	35500e	NCF 2988 CV	35500d
N 318 M	35300a	NCF 1856 CV	35500c	NCF 29/600 V	35500e	NCF 2992 V	35500d
N 319 M	35300b	NCF 1860 V	35500c	NCF 29/630 V	35500e	NCF 2992 CV	35500d
N 320 EM	35300c	NCF 1860 CV	35500c	NCF 29/670 V	35500e	NCF 2996 V	35500d
N 320 M	35300c	NCF 1864 V	35500c	NCF 29/710 V	35500e	NCF 2996 CV	35500d
N 321 M	35300d	NCF 1864 CV	35500c	NCF 29/750 V	35500e	NCF 30/500 V	35500e
N 322 EM	35300d	NCF 1868 V	35500d	NCF 29/800 V	35500e	NCF 30/530 V	35500e
N 324 EM	35300e	NCF 1868 CV	35500d	NCF 29/850 V	35500e	NCF 30/560 V	35500e
N 324 M	35300e	NCF 1872 V	35500d	NCF 29/900 V	35500e	NCF 3004 CV	35500a
N 326 EM	35300f	NCF 1872 CV	35500d	NCF 29/950 V	35500e	NCF 3005 CV	35500a
N 326 M	35300f	NCF 1876 V	35500d	NCF 2912 CV	35500a	NCF 3006 CV	35500a
N 328 EM	35300h	NCF 1876 CV	35500d	NCF 2913 CV	35500a	NCF 3007 CV	35500a
N 328 M	35300h	NCF 1880 V	35500d	NCF 2914 CV	35500a	NCF 3008 CV	35500a
N 330 EM	35400a	NCF 1880 CV	35500d	NCF 2915 CV	35500a	NCF 3009 CV	35500a



Deep Groove Ball Bearing	Self-Aligning Ball Bearing	Angular Contact Ball Bearing	
Cylindrical Roller Bearing	Tapered Roller Bearing	Spherical Roller Bearing	
Thrust Ball Bearing	Spherical Roller Thrust Bearing	Accessories Adapter & Withdrawal Sleeve	Technical & Related Information

## 95100t

## Page codes index

Item description	Page code	Item description	Page code	Item description	Page code	Item description	Page code
NCF 3010 CV	35500a	NJ 1028 M	35300h	NJ 219 EM	35300b	NJ 2232 M	35400a
NCF 3011 CV	35500a	NJ 1032 M	35400a	NJ 219 M	35300b	NJ 2234 EM	35400b
NCF 3012 CV	35500a	NJ 1034 M	35400b	NJ 220 E	35300c	NJ 2236 E	35400b
NCF 3013 CV	35500a	NJ 1036 M	35400b	NJ 220 EM	35300c	NJ 2236 EM	35400b
NCF 3014 CV	35500a	NJ 1038 M	35400c	NJ 220 M	35300c	NJ 2236 M	35400b
NCF 3015 CV	35500a	NJ 1040 M	35400c	NJ 2203 E	35100a	NJ 2238 M	35400c
NCF 3016 CV	35500a	NJ 1044 M	35400d	NJ 2204 E	35100a	NJ 224 E	35300e
NCF 3017 CV	35500a	NJ 1048 M	35400d	NJ 2204 EM	35100a	NJ 224 EM	35300e
NCF 3018 CV	35500a	NJ 1052 M	35400d	NJ 2205 E	35100b	NJ 224 M	35300e
NCF 3020 V	35500b	NJ 1056 M	35400e	NJ 2205 EM	35100b	NJ 2240 EM	35400c
NCF 3020 CV	35500b	NJ 1060 M	35400e	NJ 2206 E	35100c	NJ 2252 M	35400d
NCF 3022 CV	35500b	NJ 1064 M	35400e	NJ 2206 EM	35100c	NJ 226 E	35300f
NCF 3024 V	35500b	NJ 1080	35400f	NJ 2207 E	35100d	NJ 226 EM	35300f
NCF 3024 CV	35500b	NJ 18/1120 EM	35400k	NJ 2207 EM	35100d	NJ 226 M	35300f
NCF 3026 V	35500b	NJ 18/1180 EM	35400k	NJ 2207 M	35100d	NJ 228 EM	35300h
NCF 3026 CV	35500b	NJ 18/560 M	35400h	NJ 2208 E	35100e	NJ 228 M	35300h
NCF 3028 V	35500b	NJ 18/630 EM	35400h	NJ 2208 EM	35100e	NJ 230 EM	35400a
NCF 3028 CV	35500b	NJ 18/670	35400k	NJ 2209 E	35100f	NJ 230 M	35400a
NCF 3030 V	35500b	NJ 18/800 EM	35400k	NJ 2209 EM	35100f	NJ 2304 E	35100a
NCF 3030 CV	35500b	NJ 19/530 EM	35400h	NJ 2209 M	35100f	NJ 2304 EM	35100a
NCF 3032 V	35500b	NJ 19/850	35400k	NJ 221 M	35300d	NJ 2305 E	35100b
NCF 3032 CV	35500b	NJ 1938 M	35400c	NJ 2210 E	35100h	NJ 2305 EM	35100b
NCF 3034 V	35500b	NJ 1940 MA	35400c	NJ 2210 EM	35100h	NJ 2306 E	35100c
NCF 3034 CV	35500b	NJ 1944 M	35400d	NJ 2210 M	35100h	NJ 2306 EM	35100c
NCF 3036 V	35500b	NJ 1984 M	35400f	NJ 2211 E	35200a	NJ 2307 E	35100d
NCF 3036 CV	35500b	NJ 203	35100a	NJ 2211 EM	35200a	NJ 2307 M	35100d
NCF 3038 V	35500b	NJ 204 E	35100a	NJ 2211 M	35200a	NJ 2308 E	35100e
NCF 3038 CV	35500b	NJ 204 EM	35100a	NJ 2212 EM	35200b	NJ 2308 EM	35100e
NCF 3040 V	35500c	NJ 205 E	35100b	NJ 2213 EM	35200c	NJ 2309 EM	35100f
NCF 3040 CV	35500c	NJ 205 EM	35100b	NJ 2214 E	35200d	NJ 2309 M	35100f
NCF 3044 V	35500c	NJ 206 E	35100c	NJ 2214 EM	35200d	NJ 2310 E	35100h
NCF 3044 CV	35500c	NJ 206 EM	35100c	NJ 2214 M	35200d	NJ 2310 EM	35100h
NCF 3048 V	35500c	NJ 207 E	35100d	NJ 2215	35200e	NJ 2311 EM	35200a
NCF 3048 CV	35500c	NJ 207 EM	35100d	NJ 2216 E	35200f	NJ 2311 M	35200a
NCF 3052 V	35500c	NJ 207 M	35100d	NJ 2216 EM	35200f	NJ 2312 E	35200b
NCF 3052 CV	35500c	NJ 208 EM	35100e	NJ 2216 M	35200f	NJ 2312 EM	35200b
NCF 3056 V	35500c	NJ 208 M	35100e	NJ 2217 E	35200h	NJ 2312 EMA	35200b
NCF 3056 CV	35500c	NJ 209 E	35100f	NJ 2217 EM	35200h	NJ 2313 EM	35200c
NCF 3060 V	35500c	NJ 209 EM	35100f	NJ 2218 M	35300a	NJ 2314 E	35200d
NCF 3060 CV	35500c	NJ 210 E	35100h	NJ 2218 M	35300a	NJ 2314 EM	35200d
NCF 3064 V	35500c	NJ 210 EM	35100h	NJ 2219 EM	35300b	NJ 2314 M	35200d
NCF 3064 CV	35500c	NJ 210 M	35100h	NJ 2219 M	35300b	NJ 2314 M	35200d
NCF 3068 V	35500d	NJ 211 E	35200a	NJ 222 E	35300d	NJ 2315 E	35200e
NCF 3068 CV	35500d	NJ 211 EM	35200a	NJ 222 EM	35300d	NJ 2315 EM	35200e
NCF 3072 V	35500d	NJ 212 E	35200b	NJ 222 M	35300d	NJ 2315 M	35200e
NCF 3072 CV	35500d	NJ 212 EM	35200b	NJ 2220 EM	35300c	NJ 2316 E	35200f
NCF 3076 V	35500d	NJ 213 E	35200c	NJ 2220 M	35300c	NJ 2316 M	35200f
NCF 3076 CV	35500d	NJ 213 EM	35200c	NJ 2222 EM	35300d	NJ 2317 E	35200h
NCF 3080 V	35500d	NJ 214 E	35200d	NJ 2222 M	35300d	NJ 2317 EM	35200h
NCF 3080 CV	35500d	NJ 214 EM	35200d	NJ 2224 EM	35300e	NJ 2317 M	35200h
NCF 3088 V	35500d	NJ 215 E	35200e	NJ 2224 M	35300e	NJ 2318 E	35300a
NCF 3092 V	35500d	NJ 215 EM	35200e	NJ 2226 EM	35300f	NJ 2318 EM	35300a
NCF 3096 V	35500d	NJ 216 EM	35200f	NJ 2226 M	35300f	NJ 2318 M	35300a
NCF3084 V	35500d	NJ 217 E	35200h	NJ 2226 MA	35300f	NJ 2319 EM	35300b
NJ 10/500	35400h	NJ 217 EM	35200h	NJ 2228 EM	35300h	NJ 2319 M	35300b
NJ 1010 M	35100h	NJ 217 M	35200h	NJ 2228 M	35300h	NJ 232 EM	35400a
NJ 1016 M	35200f	NJ 218 E	35300a	NJ 2230 EM	35400a	NJ 232 M	35400a
NJ 1026 M	35300f	NJ 218 EM	35300a	NJ 2230 M	35400a	NJ 2320 E	35300c
				NJ 2232 EM	35400a	NJ 2320 EM	35300c



Deep Groove Ball Bearing	Self-Aligning Ball Bearing	Angular Contact Ball Bearing	
Cylindrical Roller Bearing	Tapered Roller Bearing	Spherical Roller Bearing	
Thrust Ball Bearing	Spherical Roller Thrust Bearing	Accessories Adapter & Withdrawal Sleeve	Technical & Related Information

# 95100u

## Page codes index

Item description	Page code	Item description	Page code	Item description	Page code	Item description	Page code
NJ 2320 M	35300c	NJ 310 M	35100h	NJ 410 M	35100h	NN 3048 K	35410b
NJ 2322 E	35300d	NJ 311 E	35200a	NJ 411 M	35200a	NN 3056 K M NA	35410b
NJ 2322 EM	35300d	NJ 311 EM	35200a	NJ 412 M	35200b	NN 3076 K M NA	35410b
NJ 2322 M	35300d	NJ 311 M	35200a	NJ 413 M	35200c	NNC 4830 CV	35600b
NJ 2324 EM	35300e	NJ 312 E	35200b	NJ 414 M	35200d	NNC 4832 CV	35600b
NJ 2324 M	35300e	NJ 312 EM	35200b	NJ 415 M	35200e	NNC 4834 CV	35600b
NJ 2326 EM	35300f	NJ 312 M	35200b	NJ 416 M	35200f	NNC 4836 CV	35600b
NJ 2326 M	35300f	NJ 313 E	35200c	NJ 417 M	35200h	NNC 4838 CV	35600b
NJ 2328 E	35300h	NJ 313 EM	35200c	NJ 418 M	35300a	NNC 4840 CV	35600c
NJ 2328 EM	35300h	NJ 313 M	35200c	NJ 420 EM	35300c	NNC 4844 CV	35600c
NJ 2328 M	35300h	NJ 314 E	35200d	NJ 420 M	35300c	NNC 4848 CV	35600c
NJ 2330 EM	35400a	NJ 314 EM	35200d	NJ 421 M	35300d	NNC 4852 CV	35600c
NJ 2330 M	35400a	NJ 314 M	35200d	NJ 422 EM	35300d	NNC 4856 CV	35600c
NJ 2332 EM	35400a	NJ 315 E	35200e	NJ 422 M	35300d	NNC 4860 CV	35600c
NJ 2332 M	35400a	NJ 315 EM	35200e	NJ 424 EM	35300e	NNC 4864 CV	35600c
NJ 2334 EM	35400b	NJ 315 M	35200e	NJ 424 M	35300e	NNC 4868 CV	35600d
NJ 2334 M	35400b	NJ 316 EM	35200f	NJ 428 EM	35300h	NNC 4872 CV	35600d
NJ 234 EM	35400b	NJ 316 M	35200f	NJ 4980 M	35400f	NNC 4876 CV	35600d
NJ 234 M	35400b	NJ 317 E	35200h	NJG 2305 CV	35500a	NNC 4912 CV	35600a
NJ 2344 M	35400d	NJ 317 EM	35200h	NJG 2306 CV	35500a	NNC 4914 CV	35600a
NJ 236 EM	35400b	NJ 317 M	35200h	NJG 2307 CV	35500a	NNC 4916 CV	35600a
NJ 236 M	35400b	NJ 318 E	35300a	NJG 2308 CV	35500a	NNC 4918 CV	35600a
NJ 238 EM	35400c	NJ 318 EM	35300a	NJG 2309 CV	35500a	NNC 4920 CV	35600a
NJ 238 M	35400c	NJ 318 M	35300a	NJG 2310 CV	35500a	NNC 4924 CV	35600b
NJ 240 EM	35400c	NJ 319 E	35300b	NJG 2311 CV	35500a	NNC 4926 CV	35600b
NJ 240 M	35400c	NJ 319 EM	35300b	NJG 2312 CV	35500a	NNC 4928 CV	35600b
NJ 244 EM	35400d	NJ 319 M	35300b	NJG 2313 CV	35500a	NNC 4930 CV	35600b
NJ 244 M	35400d	NJ 320 E	35300c	NJG 2314 CV	35500a	NNC 4932 CV	35600b
NJ 248 M	35400d	NJ 320 EM	35300c	NJG 2316 CV	35500a	NNC 4934 CV	35600b
NJ 252 M	35400d	NJ 320 M	35300c	NJG 2317 CV	35500a	NNC 4936 CV	35600b
NJ 256 M	35400e	NJ 321 M	35300d	NJG 2318 CV	35500a	NNC 4938 CV	35600b
NJ 28/1000 EM	35400k	NJ 322 E	35300d	NJG 2319 CV	35500b	NNC 4940 CV	35600c
NJ 2856 M	35400e	NJ 322 EM	35300d	NJG 2320 CV	35500b	NNC 4944 CV	35600c
NJ 2860 M	35400e	NJ 322 M	35300d	NJG 2322 CV	35500b	NNC 4948 CV	35600c
NJ 2868 M	35400e	NJ 323 M	35300e	NJG 2324 CV	35500b	NNC 4952 CV	35600c
NJ 2892 EM	35400f	NJ 324 EM	35300e	NN 3006 K M NA	35410a	NNC 4956 CV	35600c
NJ 2896 EM	35400h	NJ 324 M	35300e	NN 3007 K M NA	35410a	NNC 4960 CV	35600c
NJ 29/560	35400h	NJ 326 E	35300f	NN 3008 K M NA	35410a	NNC 4964 CV	35600c
NJ 29/630 EM	35400h	NJ 326 EM	35300f	NN 3009 K M NA	35410a	NNC 4968 CV	35600d
NJ 2988 EM	35400f	NJ 326 M	35300f	NN 3010 K M NA	35410a	NNC 4972 CV	35600d
NJ 2992	35400f	NJ 328 EM	35300h	NN 3011 K M NA	35410a	NNC 4976 CV	35600d
NJ 304 EM	35100a	NJ 328 M	35300h	NN 3012 K M NA	35410a	NNC 4980 CV	35600d
NJ 305 E	35100b	NJ 330 EM	35400a	NN 3013 K M NA	35410a	NNC4922 CV	35600a
NJ 305 EM	35100b	NJ 330 M	35400a	NN 3014 K M NA	35410a	NNCF 4830 V	35600b
NJ 305 M	35100b	NJ 332 EM	35400a	NN 3015 K M NA	35410a	NNCF 4860 V	35500c
NJ 306 E	35100c	NJ 332 M	35400a	NN 3016 K M NA	35410a	NNCF 4860 V	35600c
NJ 306 EM	35100c	NJ 334 EM	35400b	NN 3017 K M NA	35410a	NNCF 4860 V	35600c
NJ 307 E	35100d	NJ 334 M	35400b	NN 3018 K M NA	35410a	NNCF 5004 CV	35600a
NJ 307 EM	35100d	NJ 336 M	35400b	NN 3019 K M NA	35410a	NNCF 5005 CV	35600a
NJ 307 M	35100d	NJ 338 M	35400c	NN 3020 K M NA	35410a	NNCF 5006 CV	35600a
NJ 308 E	35100e	NJ 340 EM	35400c	NN 3021 K M NA	35410a	NNCF 5007 CV	35600a
NJ 308 EM	35100e	NJ 340 M	35400c	NN 3022 K M NA	35410a	NNCF 5008 CV	35600a
NJ 308 M	35100e	NJ 344 EM	35400d	NN 3024 K M NA	35410a	NNCF 5009 CV	35600a
NJ 309 E	35100f	NJ 3884 M	35400f	NN 3026 K M NA	35410a	NNCF 5010 CV	35600a
NJ 309 EM	35100f	NJ 406 M	35100c	NN 3028 K M NA	35410a	NNCF 5011 CV	35600a
NJ 309 M	35100f	NJ 407 M	35100d	NN 3030 K M NA	35410a	NNCF 5012 CV	35600a
NJ 310 E	35100h	NJ 408 M	35100e	NN 3034 K M NA	35410a	NNCF 5013 CV	35600a
NJ 310 EM	35100h	NJ 409 M	35100f	NN 3036 K M NA	35410a	NNCF 5014 CV	35600a

7821606595  
7821604051  
7821610766





Deep Groove Ball Bearing	Self-Aligning Ball Bearing	Angular Contact Ball Bearing	
Cylindrical Roller Bearing	Tapered Roller Bearing	Spherical Roller Bearing	
Thrust Ball Bearing	Spherical Roller Thrust Bearing	Accessories Adapter & Withdrawal Sleeve	Technical & Related Information

# 95100v

## Page codes index

Item description	Page code	Item description	Page code	Item description	Page code	Item description	Page code
NNCF 5015 CV	35600a	NNCL 4964 CV	35600c	NU 49/630 K M NA	35410b	NU 1064 M	35400e
NNCF 5016 CV	35600a	NNCL 4968 CV	35600d	NU 4920 K M NA	35410a	NU 1068 M	35400e
NNCF 5017 CV	35600a	NNCL 4972 CV	35600d	NU 4920 M NA	35410a	NU 1072 M	35400e
NNCF 5018 CV	35600a	NNCL 4976 CV	35600d	NU 4921 K M NA	35410a	NU 1076 M	35400f
NNCF 5020 CV	35600a	NNCL 4980	35410b	NU 4922 K M NA	35410a	NU 1080 M	35400f
NNCF 5022 CV	35600a	NNCL 4980 CV	35600d	NU 4924 K M NA	35410a	NU 1084 M	35400f
NNCF 5024 CV	35600b	NNCL4924 CV	35600b	NU 4926 K M NA	35410a	NU 1088 M	35400f
NNCF 5026 CV	35600b	NNF 130 PP 2NR	35600b	NU 4928 K M NA	35410a	NU 1092 M	35400f
NNCF 5028 CV	35600b	NNF 140 PP 2NR	35600b	NU 4930 K M NA	35410a	NU 1096 M	35400h
NNCF 5030 CV	35600b	NNF 150 PP 2NR	35600b	NU 4932 K M NA	35410a	NU 12/500 M	35400h
NNCF 5032 CV	35600b	NNF 160 PP 2NR	35600b	NU 4934 K M NA	35410a	NU 12/560 M	35400h
NNCF 5034 CV	35600b	NNF 170 PP 2NR	35600b	NU 4944 M NA	35410b	NU 18/1000 M	35400k
NNCF 5036 CV	35600b	NNF 180 PP 2NR	35600b	NU 4952 M NA	35410b	NU 18/1320 M	35400k
NNCF 5038 CV	35600b	NNF 190 PP 2NR	35600b	NU 4960 K M NA	35410b	NU 18/1700 EM	35400k
NNCF 5040 CV	35600c	NNF 200 PP 2NR	35600c	NU 4964 K M NA	35410b	NU 18/600 EM	35400h
NNCF 5044 CV	35600c	NNF 220 PP 2NR	35600c	NU 4972 M	35410b	NU 18/750 M	35400k
NNCF 5048 CV	35600c	NNF 240 PP 2NR	35600c	NU 4976 K M NA	35410b	NU 18/900 M	35400k
NNCF 5052 CV	35600c	NNF 260 PP 2NR	35600c	NU 4984 M	35410b	NU 1864 M	35400e
NNCF 5056 CV	35600c	NNF 300 PP 2NR	35600c	NU 4992 K M NA	35410b	NU 1876 M	35400f
NNCF 5060 CV	35600c	NNF 5004 PP 2NR	35600a	NU 10/530 M	35400h	NU 1880 M	35400f
NNCF 5064 CV	35600c	NNF 5005 PP 2NR	35600a	NU 10/560 M	35400h	NU 1884	35400f
NNCF 5068 CV	35600d	NNF 5006 PP 2NR	35600a	NU 10/600	35400h	NU 1896 M	35400h
NNCF 5072 CV	35600d	NNF 5007 PP 2NR	35600a	NU 10/630 EM	35400h	NU 19/1320	35400k
NNCF 5076 CV	35600d	NNF 5008 PP 2NR	35600a	NU 10/670	35400k	NU 19/500 EM	35400h
NNCL 4830 CV	35600b	NNF 5009 PP 2NR	35600a	NU 10/710 EM	35400k	NU 19/560 EM	35400h
NNCL 4832 CV	35600b	NNF 5010 PP 2NR	35600a	NU 10/750 EM	35400k	NU 19/600 EM	35400h
NNCL 4834 CV	35600b	NNF 5011 PP 2NR	35600a	NU 10/800 EM	35400k	NU 19/630 EM	35400h
NNCL 4836 CV	35600b	NNF 5012 PP 2NR	35600a	NU 1005	35100b	NU 19/630 M	35400h
NNCL 4838 CV	35600b	NNF 5013 PP 2NR	35600a	NU 1007	35100d	NU 19/670	35400k
NNCL 4840 CV	35600c	NNF 5014 PP 2NR	35600a	NU 1008 M	35100e	NU 19/710	35400k
NNCL 4844 CV	35600c	NNF 5015 PP 2NR	35600a	NU 1009 M	35100f	NU 19/850 EM	35400k
NNCL 4848 CV	35600c	NNF 5016 PP 2NR	35600a	NU 1010 M	35100h	NU 19/900 EM	35400k
NNCL 4852 CV	35600c	NNF 5017 PP 2NR	35600a	NU 1011 M	35200a	NU 1940 EM	35400c
NNCL 4856 CV	35600c	NNF 5018 PP 2NR	35600a	NU 1012 EM	35200b	NU 1948 M	35400d
NNCL 4860 CV	35600c	NNF 5019 PP 2NR	35600a	NU 1012 M	35200b	NU 1956 M	35400e
NNCL 4864 CV	35600c	NNF 5020 PP 2NR	35600a	NU 1013 M	35200c	NU 1964 M	35400e
NNCL 4868 CV	35600d	NNF 5022 PP 2NR	35600a	NU 1014 M	35200d	NU 1968 M	35400e
NNCL 4872 CV	35600d	NNF 5024 PP 2NR	35600b	NU 1016 M	35200f	NU 1980 M	35400f
NNCL 4876 CV	35600d	NNF 5026 PP 2NR	35600b	NU 1017 M	35200h	NU 1988 M	35400f
NNCL 4912 CV	35600a	NNF 5028 PP 2NR	35600b	NU 1018 M	35300a	NU 20/500 EM	35400h
NNCL 4914 CV	35600a	NNF 5030 PP 2NR	35600b	NU 1019 M	35300b	NU 20/530 EM	35400h
NNCL 4916 CV	35600a	NNF 5032 PP 2NR	35600b	NU 1020 M	35300c	NU 20/560 EM	35400h
NNCL 4918 CV	35600a	NNF 5034 PP 2NR	35600b	NU 1021 M	35300d	NU 20/600 EM	35400h
NNCL 4920 CV	35600a	NNF 5036 PP 2NR	35600b	NU 1022 M	35300d	NU 20/630 EM	35400h
NNCL 4922 CV	35600a	NNF 5038 PP 2NR	35600b	NU 1024 M	35300e	NU 20/710 EM	35400k
NNCL 4926 CV	35600b	NNF 5040 PP 2NR	35600c	NU 1026 M	35300f	NU 20/750 EM	35400k
NNCL 4928 CV	35600b	NNF 5044 PP 2NR	35600c	NU 1028 M	35300h	NU 20/800 EM	35400k
NNCL 4930 CV	35600b	NNF 5048 PP 2NR	35600c	NU 1030 M	35400a	NU 202 E	35100a
NNCL 4932 CV	35600b	NNF 5052 PP 2NR	35600c	NU 1032 M	35400a	NU 203 EM	35100a
NNCL 4934 CV	35600b	NNF 5056 PP 2NR	35600c	NU 1034 M	35400b	NU 203 M	35100a
NNCL 4936 CV	35600b	NNF 5060 PP 2NR	35600c	NU 1036 M	35400b	NU 204 E	35100a
NNCL 4938 CV	35600b	NU 41/500 M	35410b	NU 1038 M	35400c	NU 204 EM	35100a
NNCL 4940 CV	35600c	NU 41/630 M NA	35410b	NU 1040 M	35400c	NU 205 E	35100b
NNCL 4944 CV	35600c	NU 4164 M	35410b	NU 1044 M	35400d	NU 205 EM	35100b
NNCL 4948 CV	35600c	NU 4172 M	35410b	NU 1048 M	35400d	NU 2052 EM	35400d
NNCL 4952 CV	35600c	NU 4188 M	35410b	NU 1052 M	35400d	NU 2056 M	35400e
NNCL 4956 CV	35600c	NU 49/500 K M NA	35410b	NU 1056 M	35400e	NU 206 E	35100c
NNCL 4960 CV	35600c	NU 49/530 K M NA	35410b	NU 1060 M	35400e	NU 206 EM	35100c

7821606595  
7821604051  
7821610766

[contacto@sidiaz.com](mailto:contacto@sidiaz.com)

[www.sidiaz.com](http://www.sidiaz.com)





Deep Groove Ball Bearing	Self-Aligning Ball Bearing	Angular Contact Ball Bearing	
Cylindrical Roller Bearing	Tapered Roller Bearing	Spherical Roller Bearing	
Thrust Ball Bearing	Spherical Roller Thrust Bearing	Accessories Adapter & Withdrawal Sleeve	Technical & Related Information

## 95100w

## Page codes index

Item description	Page code	Item description	Page code	Item description	Page code	Item description	Page code
NU 2060 M	35400e	NU 2208 EMA	35100e	NU 2268 M	35400e	NU 2330 EM	35400a
NU 2064 M	35400e	NU 2209 E	35100f	NU 2272 M	35400e	NU 2330 M	35400a
NU 207 E	35100d	NU 2209 EM	35100f	NU 2276 EM	35400f	NU 2332 EM	35400a
NU 207 EM	35100d	NU 2209 M	35100f	NU 228 EM	35300h	NU 2332 M	35400a
NU 2072 M	35400e	NU 221 M	35300d	NU 228 M	35300h	NU 2334 EM	35400b
NU 2076 EM	35400f	NU 2210 E	35100h	NU 2280 M	35400f	NU 2334 M	35400b
NU 208 E	35100e	NU 2210 EM	35100h	NU 2292 M	35400f	NU 2336 EM	35400b
NU 208 E	35100e	NU 2210 M	35100h	NU 230 EM	35400a	NU 2336 M	35400b
NU 208 EM	35100e	NU 2211 EM	35200a	NU 230 M	35400a	NU 2338 EM	35400c
NU 208 M	35100e	NU 2211 M	35200a	NU 230 MA	35400a	NU 234 EM	35400b
NU 2080 EM	35400f	NU 2212 E	35200b	NU 2304 E	35100a	NU 234 M	35400b
NU 2084 EM	35400f	NU 2212 EM	35200b	NU 2304 EM	35100a	NU 2340 EM	35400c
NU 2088 EM	35400f	NU 2213 EM	35200c	NU 2305 E	35100b	NU 2340 M	35400c
NU 209 E	35100f	NU 2214 E	35200d	NU 2305 EM	35100b	NU 2344 EM	35400d
NU 2092 EM	35400f	NU 2214 EM	35200d	NU 2306 E	35100c	NU 2344 M	35400d
NU 2096 M	35400h	NU 2215 EM	35200e	NU 2307 E	35100d	NU 2348 M	35400d
NU 210 E	35100h	NU 2215 M	35200e	NU 2307 M	35100d	NU 2352 M	35400d
NU 210 EM	35100h	NU 2216 EM	35200f	NU 2308 E	35100e	NU 2356 M	35400e
NU 211 E	35200a	NU 2216 M	35200f	NU 2308 EM	35100e	NU 236 EM	35400b
NU 211 EM	35200a	NU 2217 EM	35200h	NU 2308 M	35100e	NU 236 M	35400b
NU 212 E	35200b	NU 2218 M	35300a	NU 2309 EM	35100f	NU 2360 M	35400e
NU 212 EM	35200b	NU 2219 EM	35300b	NU 2309 M	35100f	NU 2372	35400e
NU 213 E	35200c	NU 2219 M	35300b	NU 2310 E	35100h	NU 238 EM	35400c
NU 213 EM	35200c	NU 222 EM	35300d	NU 2310 EM	35100h	NU 238 M	35400c
NU 213 M	35200c	NU 222 M	35300d	NU 2311 EM	35200a	NU 240 EM	35400c
NU 214 E	35200d	NU 2220 EM	35300c	NU 2311 M	35200a	NU 240 M	35400c
NU 214 EM	35200d	NU 2220 M	35300c	NU 2312 E	35200b	NU 244 EM	35400d
NU 214 M	35200d	NU 2222 EM	35300d	NU 2312 EM	35200b	NU 244 M	35400d
NU 215 E	35200e	NU 2222 M	35300d	NU 2312 M	35200b	NU 248 M	35400d
NU 215 EM	35200e	NU 2224 EM	35300e	NU 2313 E	35200c	NU 252 M	35400d
NU 216 E	35200f	NU 2224 M	35300e	NU 2313 EM	35200c	NU 256 M	35400e
NU 216 EM	35200f	NU 2226 EM	35300f	NU 2314 E	35200d	NU 260 M	35400e
NU 216 M	35200f	NU 2226 M	35300f	NU 2314 EM	35200d	NU 264 M	35400e
NU 217 E	35200h	NU 2228 EM	35300h	NU 2314 M	35200d	NU 28/500 EM	35400h
NU 217 EM	35200h	NU 2228 M	35300h	NU 2315 E	35200e	NU 28/600 EM	35400h
NU 217 M	35200h	NU 2230 EM	35400a	NU 2315 M	35200e	NU 28/630 M	35400h
NU 218 E	35300a	NU 2230 M	35400a	NU 2316 EM	35200f	NU 28/850 M	35400k
NU 218 EM	35300a	NU 2232 EM	35400a	NU 2316 EMA	35200f	NU 28/900 M	35400k
NU 218 M	35300a	NU 2232 M	35400a	NU 2316 M	35200f	NU 2860 M	35400e
NU 2180 M	35400f	NU 2234 EM	35400b	NU 2317 E	35200h	NU 2864 M	35400e
NU 219 E	35300b	NU 2234 M	35400b	NU 2317 EM	35200h	NU 2888 EM	35400f
NU 219 EM	35300b	NU 2236 EM	35400b	NU 2317 M	35200h	NU 29/1060 EM	35400k
NU 219 M	35300b	NU 2236 M	35400b	NU 2318 E	35300a	NU 29/1180 EM	35400k
NU 220 E	35300c	NU 2238 EM	35400c	NU 2318 EM	35300a	NU 29/1180 M	35400k
NU 220 E	35300c	NU 2238 M	35400c	NU 2318 M	35300a	NU 29/500	35400h
NU 220 EM	35300c	NU 224 EM	35300e	NU 2319 M	35300b	NU 29/630 EM	35400h
NU 220 EM	35300c	NU 224 M	35300e	NU 232 EM	35400a	NU 29/710 EM	35400k
NU 220 M	35300c	NU 2240 EM	35400c	NU 232 M	35400a	NU 29/900 EM	35400k
NU 2203 E	35100a	NU 2240 M	35400c	NU 2320 EM	35300c	NU 29/950	35400k
NU 2204 E	35100a	NU 2244 EM	35400d	NU 2320 M	35300c	NU 2968 M	35400e
NU 2204 EM	35100a	NU 2244 M	35400d	NU 2322 EM	35300d	NU 2980 EM	35400f
NU 2205 E	35100b	NU 2248 M	35400d	NU 2322 M	35300d	NU 2980 M	35400f
NU 2205 EM	35100b	NU 2252 M	35400d	NU 2324 EM	35300e	NU 2984 M	35400f
NU 2206 E	35100c	NU 2256 EM	35400e	NU 2324 M	35300e	NU 2992	35400f
NU 2206 EM	35100c	NU 226 EM	35300f	NU 2326 EM	35300f	NU 30/500	35400h
NU 2206 M	35100c	NU 226 M	35300f	NU 2326 M	35300f	NU 30/630	35400h
NU 2207 E	35100d	NU 2260 M	35400e	NU 2328 EM	35300h	NU 30/670 M	35400k
NU 2207 EM	35100d	NU 2264	35400e	NU 2328 M	35300h	NU 303	35100a



Deep Groove Ball Bearing	Self-Aligning Ball Bearing	Angular Contact Ball Bearing	
Cylindrical Roller Bearing	Tapered Roller Bearing	Spherical Roller Bearing	
Thrust Ball Bearing	Spherical Roller Thrust Bearing	Accessories Adapter & Withdrawal Sleeve	Technical & Related Information

# 95100x

## Page codes index

Item description	Page code	Item description	Page code	Item description	Page code	Item description	Page code
NU 304 EM	35100a	NU 319 M	35300b	NU 428 EM	35300h	NUP 2212 EM	35200b
NU 305 E	35100b	NU 3192	35400f	NU 6/700	35400k	NUP 2213 EM	35200c
NU 305 EM	35100b	NU 3192 M	35400f	NU 60/500 M	35400h	NUP 2214 E	35200d
NU 305 M	35100b	NU 3196 EM	35400h	NUP 10/630 EM	35400h	NUP 2214 EM	35200d
NU 3052 M	35400d	NU 320 EM	35300c	NUP 1040 M	35400c	NUP 2215	35200e
NU 306 E	35100c	NU 320 M	35300c	NUP 1052 M	35400d	NUP 2215 EM	35200e
NU 306 EM	35100c	NU 321 EM	35300d	NUP 1064 M	35400e	NUP 2216 EM	35200f
NU 306 M	35100c	NU 322 E	35300d	NUP 1080 M	35400f	NUP 2216 M	35200f
NU 3060 M	35400e	NU 322 EM	35300d	NUP 1876 M	35400f	NUP 2217 EM	35200h
NU 3064 M	35400e	NU 322 M	35300d	NUP 19/600 EM	35400h	NUP 2218 M	35300a
NU 307 E	35100d	NU 324 EM	35300e	NUP 19/600 M	35400h	NUP 2219 M	35300b
NU 307 EM	35100d	NU 324 M	35300e	NUP 19/670	35400k	NUP 222 E	35300d
NU 307 M	35100d	NU 326 E	35300f	NUP 204 E	35100a	NUP 222 EM	35300d
NU 3072 M	35400e	NU 326 EM	35300f	NUP 204 EM	35100a	NUP 222 M	35300d
NU 3076 EM	35400f	NU 326 M	35300f	NUP 205 E	35100b	NUP 2220 M	35300c
NU 308 E	35100e	NU 328 EM	35300h	NUP 206 E	35100c	NUP 2222 M	35300d
NU 308 EM	35100e	NU 328 M	35300h	NUP 206 EM	35100c	NUP 2224 M	35300e
NU 308 M	35100e	NU 330 EM	35400a	NUP 206 M	35100c	NUP 2226 M	35300f
NU 3080 M	35400f	NU 330 M	35400a	NUP 207 E	35100d	NUP 2228 M	35300h
NU 309 E	35100f	NU 332 EM	35400a	NUP 208 E	35100e	NUP 2230 M	35400a
NU 309 EM	35100f	NU 332 M	35400a	NUP 208 EM	35100e	NUP 2232 M	35400a
NU 309 M	35100f	NU 334 EM	35400b	NUP 209 E	35100f	NUP 2234 EM	35400b
NU 3092 EM	35400f	NU 334 M	35400b	NUP 209 EM	35100f	NUP 2234 M	35400b
NU 3092 M	35400f	NU 336 EM	35400b	NUP 210 E	35100h	NUP 2236 EM	35400b
NU 31/500	35400h	NU 336 M	35400b	NUP 211 E	35200a	NUP 2236 M	35400b
NU 31/530 EM	35400h	NU 338 EM	35400c	NUP 211 EM	35200a	NUP 224 EM	35300e
NU 310 E	35100h	NU 338 M	35400c	NUP 212 E	35200b	NUP 224 M	35300e
NU 310 EM	35100h	NU 340 EM	35400c	NUP 213 E	35200c	NUP 2244 M	35400d
NU 311 EM	35200a	NU 340 M	35400c	NUP 213 EM	35200c	NUP 226 M	35300f
NU 311 EMA	35200a	NU 344 EM	35400d	NUP 213 M	35200c	NUP 228 EM	35300h
NU 312 E	35200b	NU 348 M	35400d	NUP 214 E	35200d	NUP 228 M	35300h
NU 312 EM	35200b	NU 352 M	35400d	NUP 214 EM	35200d	NUP 230 M	35400a
NU 312 M	35200b	NU 356 M	35400e	NUP 215 E	35200e	NUP 2304 EM	35100a
NU 313 E	35200c	NU 360 M	35400e	NUP 216 E	35200f	NUP 2305 E	35100b
NU 313 EM	35200c	NU 39/1060 EM	35400k	NUP 216 M	35200f	NUP 2306 E	35100c
NU 313 M	35200c	NU 405 M	35100b	NUP 217 E	35200h	NUP 2306 EM	35100c
NU 314 E	35200d	NU 406 M	35100c	NUP 217 EM	35200h	NUP 2306 M	35100c
NU 314 EM	35200d	NU 407 M	35100d	NUP 217 M	35200h	NUP 2307 E	35100d
NU 314 M	35200d	NU 408 M	35100e	NUP 218 E	35300a	NUP 2308 E	35100e
NU 315 E	35200e	NU 409 M	35100f	NUP 218 EM	35300a	NUP 2308 EM	35100e
NU 315 EM	35200e	NU 410 M	35100h	NUP 219 EM	35300b	NUP 2309 E	35100f
NU 315 M	35200e	NU 411 M	35200a	NUP 219 M	35300b	NUP 2309 EM	35100f
NU 3152 M	35400d	NU 412 M	35200b	NUP 220 E	35300c	NUP 2309 M	35100f
NU 3156 M	35400e	NU 413 M	35200c	NUP 220 M	35300c	NUP 2310 E	35100h
NU 316 E	35200f	NU 414 M	35200d	NUP 2203 E	35100a	NUP 2311 EM	35200a
NU 316 EM	35200f	NU 415 M	35200e	NUP 2204 E	35100a	NUP 2312 E	35200b
NU 316 M	35200f	NU 416 M	35200f	NUP 2205 E	35100b	NUP 2312 EM	35200b
NU 3164 M	35400e	NU 417 M	35200h	NUP 2205 EM	35100b	NUP 2312 EMA	35200b
NU 317 EM	35200h	NU 418 M	35300a	NUP 2206 E	35100c	NUP 2313 EM	35200c
NU 317 M	35200h	NU 419 M	35300b	NUP 2207 E	35100d	NUP 2314 E	35200d
NU 3172	35400e	NU 420 EM	35300c	NUP 2208 E	35100e	NUP 2316 M	35200f
NU 318 E	35300a	NU 420 M	35300c	NUP 2208 EM	35100e	NUP 2317 EM	35200h
NU 318 EM	35300a	NU 421 M	35300d	NUP 2209 E	35100f	NUP 2318 E	35300a
NU 318 M	35300a	NU 422 EM	35300d	NUP 2210 E	35100h	NUP 2318 M	35300a
NU 3180 M	35400f	NU 422 M	35300d	NUP 2210 EM	35100h	NUP 2319 M	35300b
NU 3184 EM	35400f	NU 424 EM	35300e	NUP 2211 E	35200a	NUP 232 EM	35400a
NU 3188	35400f	NU 424 M	35300e	NUP 2211 EM	35200a	NUP 232 M	35400a
NU 319 EM	35300b	NU 426 M	35300f	NUP 2212 E	35200b	NUP 2320 M	35300c



Deep Groove Ball Bearing	Self-Aligning Ball Bearing	Angular Contact Ball Bearing	
Cylindrical Roller Bearing	Tapered Roller Bearing	Spherical Roller Bearing	
Thrust Ball Bearing	Spherical Roller Thrust Bearing	Accessories Adapter & Withdrawal Sleeve	Technical & Related Information

# 9 5 1 0 0 z

## Page codes index

Item description	Page code	Item description	Page code	Item description	Page code	Item description	Page code
NUP 2322 M	35300d	NUP 336 M	35400b	S6303 2RS	20200a	WJ120/240 M	35300e
NUP 2324 M	35300e	NUP 3988 EM	35400f	S6304 2RS	20200a	WJP 120/240 M	35300e
NUP 2326	35300f	NUP 405 M	35100b	S6305 2RS	20200b		
NUP 2328 M	35300h	NUP 408 M	35100e	S6306 2RS	20200b		
NUP 234 M	35400b	NUP 409 M	35100f	S6307 2RS	20200b		
NUP 2344 M	35400d	NUP 411	35200a	S6308 2RS	20200b		
NUP 236 M	35400b	NUP 412 M	35200b	S6309 2RS	20200b		
NUP 238 M	35400c	NUP 413 M	35200c	S6310 2RS	20200b		
NUP 240 M	35400c	NUP 414 M	35200d	S6311 2RS	20200b		
NUP 244 M	35400d	NUP 415	35200e	S635 2RS	20200a		
NUP 252 M	35400d	NUP 416	35200f	S636 2RS	20200a		
NUP 29/530	35400h	NUP 416 M	35200f	S637 2RS	20200a		
NUP 29/600 M	35400h	NUP 418	35300a	S638 2RS	20200a		
NUP 29/950	35400k	NUP 421 M	35300d	S639 2RS	20200a		
NUP 2992	35400f	NUP 422 M	35300d	S6800 2RS	20200a		
NUP 304 EM	35100a	NUP 6/700	35400k	S6801 2RS	20200a		
NUP 305 EM	35100b	S6000 2RS	20200a	S6802 2RS	20200a		
NUP 305 M	35100b	S6001 2RS	20200a	S6803 2RS	20200a		
NUP 306 E	35100c	S6002 2RS	20200a	S6804 2RS	20200a		
NUP 307 E	35100d	S6003 2RS	20200a	S6805 2RS	20200b		
NUP 307 EM	35100d	S6004 2RS	20200a	S6806 2RS	20200b		
NUP 308 E	35100e	S6005 2RS	20200b	S6807 2RS	20200b		
NUP 308 EM	35100e	S6006 2RS	20200b	S6808 2RS	20200b		
NUP 309 E	35100f	S6007 2RS	20200b	S6809 2RS	20200b		
NUP 309 EM	35100f	S6008 2RS	20200b	S6810 2RS	20200b		
NUP 310 E	35100h	S6009 2RS	20200b	S6811 2RS	20200b		
NUP 310 EM	35100h	S6010 2RS	20200b	S6812 2RS	20200b		
NUP 311 E	35200a	S6011 2RS	20200b	S6813 2RS	20200b		
NUP 311 EM	35200a	S6012 2RS	20200b	S6814 2RS	20200b		
NUP 312 E	35200b	S6013 2RS	20200b	S6815 2RS	20200b		
NUP 312 EM	35200b	S6014 2RS	20200b	S6816 2RS	20200b		
NUP 312 M	35200b	S605 2RS	20200a	S685 2RS	20200a		
NUP 313 E	35200c	S606 2RS	20200a	S686 2RS	20200a		
NUP 313 EM	35200c	S607 2RS	20200a	S687 2RS	20200a		
NUP 314 E	35200d	S608 2RS	20200a	S688 2RS	20200a		
NUP 314 EM	35200d	S609 2RS	20200a	S689 2RS	20200a		
NUP 314ENM	35200d	S6200 2RS	20200a	S6900 2RS	20200a		
NUP 315 E	35200e	S6201 2RS	20200a	S6901 2RS	20200a		
NUP 315 EM	35200e	S6202 2RS	20200a	S6902 2RS	20200a		
NUP 316 M	35200f	S6203 2RS	20200a	S6903 2RS	20200a		
NUP 317 EM	35200h	S6204 2RS	20200a	S6904 2RS	20200a		
NUP 318 E	35300a	S6205 2RS	20200b	S6905 2RS	20200b		
NUP 318 EM	35300a	S6206 2RS	20200b	S6906 2RS	20200b		
NUP 319	35300b	S6207 2RS	20200b	S6907 2RS	20200b		
NUP 320 M	35300c	S6208 2RS	20200b	S6908 2RS	20200b		
NUP 322 E	35300d	S6209 2RS	20200b	S6909 2RS	20200b		
NUP 322 EM	35300d	S6210 2RS	20200b	S6910 2RS	20200b		
NUP 322 M	35300d	S6211 2RS	20200b	S6911 2RS	20200b		
NUP 324 EM	35300e	S6212 2RS	20200b	S6912 2RS	20200b		
NUP 324 M	35300e	S6213 2RS	20200b	S6913 2RS	20200b		
NUP 326 E	35300f	S625 2RS	20200a	S6914 2RS	20200b		
NUP 326 EM	35300f	S626 2RS	20200a	S6915 2RS	20200b		
NUP 326 M	35300f	S627 2RS	20200a	S6916 2RS	20200b		
NUP 328 EM	35300h	S628 2RS	20200a	S695 2RS	20200a		
NUP 328 M	35300h	S629 2RS	20200a	S696 2RS	20200a		
NUP 330 M	35400a	S6300 2RS	20200a	S697 2RS	20200a		
NUP 332 M	35400a	S6301 2RS	20200a	S698 2RS	20200a		
NUP 334	35400b	S6302 2RS	20200a	S699 2RS	20200a		





Deep Groove Ball Bearing	Self-Aligning Ball Bearing	Angular Contact Ball Bearing	
Cylindrical Roller Bearing	Tapered Roller Bearing	Spherical Roller Bearing	
Thrust Ball Bearing	Spherical Roller Thrust Bearing	Accessories Adapter & Withdrawal Sleeve	Technical & Related Information



## 95500a

### Standard terms and conditions of: Sale – Products & Services

REGAL BELOIT BELGIUM nv. T&C\_Edition 03/2015

continue ►

#### 1. DEFINITIONS:

In these Terms and Conditions of Sale, "Seller" means REGAL BELOIT BELGIUM nv, "Buyer" means the person, firm, company or corporation by whom the order is given.

#### 2. THE CONTRACT:

2.1 All orders must be in writing and are accepted subject to these Terms and Conditions of Sale. No terms or conditions put forward by Buyer and no representations, warranties, guarantees or other statements not contained in Seller's quotation or Acknowledgement of Order nor otherwise expressly agreed in writing by Seller shall be binding on Seller.

2.2 The Contract shall become effective only upon the date of acceptance of Buyer's order on Seller's Acknowledgement of Order form or upon the date of fulfilment of all conditions precedent stipulated in the Contract, whichever is the later (the "Effective Date"). If the details of the Goods described in Seller's quotation differ from those set out in the Acknowledgement of Order Form the latter shall apply.

2.3 No alteration or variation to the Contract shall apply unless agreed in writing by both parties. However, Seller reserves the right to effect minor modifications and/or improvements to the Goods before delivery provided that the performance of the Goods is not adversely affected and that neither the Contract Price nor the delivery date is affected.

#### 3. VALIDITY OF QUOTATION AND PRICES:

3.1 Unless previously withdrawn, Seller's quotation is open for acceptance within the period stated therein or, when no period is so stated, within thirty days after its date.

3.2 Prices are firm for delivery within the period stated in Seller's quotation and are exclusive of (a) Value Added Tax and (b) any similar and other taxes, duties, levies or other like charges arising outside Belgium in connection with the performance of the Contract.

3.3 Prices (a) are for Goods delivered EXW (Ex works) Seller's shipping point, exclusive of freight, insurance and handling unless otherwise stated in the Seller's order confirmation.

#### 4. PAYMENT:

4.1 Payment shall be made: (a) in full without set-off, counterclaim or withholding of any kind (save where and to the extent that this cannot by law be excluded); and (b) in the currency of Seller's order confirmation within thirty days of date of invoice unless otherwise specified by Seller's Finance Department. Goods will be invoiced at any time after their readiness for dispatch has been notified to Buyer. Without prejudice to Seller's other rights, Seller reserves the right to: (i) charge interest on any overdue sums at 4% above the base lending rate of Fortis Bank, Brussels (or such higher rate stipulated by applicable law) during the period of delay; (ii) suspend performance of the Contract (including withholding shipment) in the event that Buyer fails or in Seller's reasonable opinion it appears that Buyer is likely to fail to make payment when due under the Contract or any other contract; and (iii) at any time require such reasonable security for payment as Seller may deem reasonable.

#### 5. DELIVERY PERIOD:

5.1 Unless otherwise stated in Seller's order confirmation, all periods stated for delivery or completion run from the Effective Date and are to be treated as estimates only not involving any contractual obligations.

5.2 If Seller is delayed in or prevented from performing any of its obligations under the Contract due to the acts or omissions of Buyer or its agents (including but not limited to failure to provide specifications and/or fully dimensioned working drawings and/or such other information as Seller reasonably requires to proceed expeditiously with its obligations under the Contract), the delivery/completion period and the Contract Price shall both be adjusted accordingly.

5.3 If delivery is delayed due to any act or omission of Buyer, or if having been notified that the Goods are ready for despatch, Buyer fails to take delivery or provide adequate shipping instructions, Seller shall be entitled to place the Goods into a suitable store at Buyer's expense. Upon placing the Goods into the store, delivery shall be deemed to be complete, risk in the Goods shall pass to Buyer and Buyer shall pay Seller accordingly.

#### 6. FORCE MAJEURE:

6.1 Force Majeure of any kind, unforeseeable production, traffic or shipping disturbances, war, acts of terrorism, fire, floods, unforeseeable shortages of labor, utilities or raw materials and supplies, strikes, lockouts, acts of government, and any other hindrances beyond the control of the party obliged to

perform which diminish, delay or prevent production, shipment, acceptance or use of the goods, or make it an unreasonable proposition, shall relieve the party from its obligation to supply or take delivery, as the case may be, as long as and to the extent that the hindrance prevails. If, as a result of the hindrance, supply and/or acceptance is delayed by more than eight weeks, either party shall have

the right to cancel the contract. Should the Seller's suppliers fail to supply him in whole or in part, the Seller shall not be under obligation to purchase from other sources. In such cases, the Seller shall have the right to distribute the available quantities among his customers while at the same time taking into account his captive requirements.

#### 7. DELIVERY, RISK & TITLE:

7.1 Unless otherwise expressly stated in the Contract, the Goods will be delivered

red Ex Works to the destination named in the Contract. Risk of loss of or damage to the Goods shall pass to Buyer upon delivery as aforesaid and Buyer shall be responsible for insurance of the Goods after risk has so passed. Delivery terms used in the Contract shall be defined in accordance with the latest version of Incoterms.

7.2 Title to the Goods shall pass to Buyer upon delivery in accordance with Clause 7.1.

7.3 Claims for shortfalls in quantity or for incorrect delivery shall be void if made more than 14 days after receipt by the customer.

#### 8. DEFECTS AFTER DELIVERY:

8.1 Seller warrants (i) subject to the other provisions of the Contract, good title to and the unencumbered use of the Goods; (ii) that Goods manufactured by Seller and/or Seller's Affiliates shall conform with Seller's specifications therefore and be free of defects in materials and workmanship. Seller will make good by the supply of a replacement part or parts, any defects which, under proper use, care and maintenance, appear in Goods of Seller's Affiliates' manufacture and which are reported to Seller within 12 calendar months after their delivery (the "Warranty Period") and which arise solely from faulty materials or workmanship: provided always that defective items are returned to Seller at Buyer's cost carriage and insurance prepaid within the Warranty Period. Repaired or replacement items will be delivered by Seller at Seller's cost to Buyer. Goods replaced in accordance with this Clause 10.1 shall be subject to the foregoing warranty for the unexpired portion of the Warranty Period or for ninety days from the date of their return to Buyer (or completion of correction in the case of Services), whichever expires the later.

8.2 Notwithstanding Clause 8.1, Seller shall not be liable for any defects caused by: fair wear and tear; materials or workmanship made, furnished or specified by Buyer; non-compliance with Seller's storage, installation, operation or environmental requirements; lack of proper maintenance; any modification or repair not previously authorised by Seller in writing. Seller's costs incurred in investigating and rectifying such defects shall be paid by Buyer upon demand. Buyer shall at all times remain solely responsible for the adequacy and accuracy of all information supplied by it.

8.3 Subject to Clause 10.1, the foregoing constitutes Seller's sole warranty and Buyer's exclusive remedy for breach thereof. No representations, warranties or conditions of any kind, express or implied, shall apply as to satisfactory quality, merchantability, fitness for any particular purpose or any other matter with respect to any of the Goods.

#### 9. PATENT, ETC. INFRINGEMENT:

9.1 Subject to the limitations set forth in Clause 10, Seller shall indemnify Buyer in the event of any claim for infringement of Letters Patent, Registered Design, Design Right, Trade Mark or Copyright ("Intellectual Property Rights") existing at the date of formation of the Contract arising from the use or sale of the Goods, against all reasonable costs and damages awarded against Buyer in any action for such infringement, or for which Buyer may become liable in any such action, provided always that Seller shall not be liable to so indemnify Buyer in the event that: (i) such infringement arises as a result of Seller having followed a design or instruction furnished or given by Buyer, or the Goods having been used in a manner or for a purpose or in a country not specified by or disclosed to Seller prior to the date of the Contract or in association or combination with any other equipment or software, or (ii) Seller has at its expense procured for Buyer the right to continue to use the Goods or has modified or replaced the Goods so that the Goods no longer infringe.

(iii) Buyer has failed to give Seller the earliest possible notice in writing of any claim made or to be made or of any action threatened or brought against Buyer and/or Buyer has failed to permit Seller, at Seller's expense, to conduct and control any litigation that may ensue and all negotiations for a settlement of the claim, or

(iv) Buyer has made without Seller's prior written consent any admission which is or may be prejudicial to Seller in respect of any such claim or action, or

(v) the Goods have been modified without Seller's prior written authorisation.

9.2 Buyer warrants that any design or instructions furnished or given by it shall not cause Seller to infringe any Intellectual Property Rights in the performance of Seller's obligations under the Contract and shall indemnify Seller against all reasonable costs and damages which Seller may incur as a result of any breach of such warranty.

#### 10. LIMITATION OF LIABILITY:

Supplier's maximum aggregate liability for any and all losses, liabilities, expenses (including legal expenses), damages, claims or actions incurred under or in connection with a specific order or a particular blanket order (CALL-OFF order) issued, arising in or by virtue of breach of contract, tort (including negligence), misrepresentation, breach of statutory duty, strict liability, infringement of intellectual property rights or otherwise, shall in no circumstances exceed a sum equal to the total price of the Call-Off in question.

#### 11. STATUTORY AND OTHER REGULATIONS:

11.1 If Seller's obligations under the Contract shall be increased or reduced by reason of the making or amendment after the date of Seller's quotation of any law or any order, regulation or bye-law having the force of law that shall affect the performance of Seller's obligations under the Contract, the Contract Price and delivery period shall be adjusted accordingly and/or performance of the Contract suspended or terminated, as appropriate.





Deep Groove Ball Bearing	Self-Aligning Ball Bearing	Angular Contact Ball Bearing	
Cylindrical Roller Bearing	Tapered Roller Bearing	Spherical Roller Bearing	
Thrust Ball Bearing	Spherical Roller Thrust Bearing	Accessories Adapter & Withdrawal Sleeve	Technical & Related Information



## 9 | 5 | 5 | 0 | 0 | b

### Standard terms and conditions of: Sale – Products & Services

REGAL BELOIT BELGIUM nv. T&C\_Edition 03/2015

[back](#)

#### 12. COMPLIANCE WITH LAWS

Buyer agrees that all applicable import, export control and sanctions laws, regulations, orders and requirements, as they may be amended from time to time, including without limitation those of the United States, the European Union and the jurisdictions in which Seller and Buyer are established or from which items may be supplied, and the requirements of any licenses, authorisations, general licences or licence exceptions relating thereto will apply to its receipt and use of goods. In no event shall Buyer use, transfer, release, export or re-export any such goods in violation of such applicable laws, regulations, orders or requirements or the requirements of any licences, authorisations or licence exceptions relating thereto. Buyer agrees furthermore that it shall not engage in any activity that would expose the Seller to a risk of penalties under laws and regulations of any relevant jurisdiction prohibiting improper payments, including but not limited to bribes, to officials of any government or of any agency, instrumentality or political subdivision thereof, to political parties or political party officials or candidates for public office, or to any employee of any customer or supplier. Buyer agrees to comply with all appropriate legal, ethical and compliance requirements.

#### 13. DEFAULT, INSOLVENCY AND CANCELLATION:

Seller shall be entitled, without prejudice to any other rights it may have, to cancel the Contract forthwith, wholly or partly, by notice in writing to Buyer, if (a) Buyer is in default of any of its obligations under the Contract and fails, within 30 (thirty) days of the date of Seller's notification in writing of the existence of the default, either to rectify such default if it is reasonably capable of being rectified within such period or, if the default is not reasonably capable of being rectified within such period, to take action to remedy the default or (b) on the occurrence of an Insolvency Event in relation to Buyer. "Insolvency Event" in relation to Buyer means any of the following: (i) a meeting of creditors of Buyer being held or an arrangement or composition with or for the benefit of its creditors being proposed by or in relation to Buyer; (ii) a chargeholder, receiver, administrative receiver or similar person taking possession of or being appointed over or any distress, execution or other process being levied or enforced (and not being discharged within seven days) on the whole or a material part of the assets of Buyer; (iii) Buyer ceasing to carry on business or being unable to pay its debts; (iv) Buyer or its directors or the holder of a qualifying floating charge giving notice of their intention to appoint, or making an application to the court for the appointment of, an administrator; (v) a petition being presented (and not being discharged within 28 days) or a resolution being passed or an order being made for the administration or the winding-up, bankruptcy or dissolution of Buyer; or (vi) the happening in relation to Buyer of an event analogous to any of the above in any jurisdiction in which it is incorporated or resident or in which it carries on business or has assets. Seller shall be entitled to recover from Buyer or Buyer's representative all costs and damages incurred by Seller as a result of such cancellation, including a reasonable allowance for overheads and profit (including but not limited to loss of prospective profits and overheads).

#### 14. MISCELLANEOUS:

14.1 No waiver by either party with respect to any breach or default or of any right or remedy and no course of dealing, shall be deemed to constitute a continuing waiver of any other breach or default or of any other right or remedy, unless such waiver be expressed in writing and signed by the party to be bound.

14.2 If any clause, sub-clause or other provision of the Contract is invalid under any statute or rule of law, such provision, to that extent only, shall be deemed to be omitted without affecting the validity of the remainder of the Contract.

14.3 Buyer shall not be entitled to assign its rights or obligations hereunder without the prior written consent of Seller.

14.4 Seller enters into the Contract as principal. Buyer agrees to look only to Seller for due performance of the Contract.

14.5 GOODS PROVIDED HEREUNDER ARE NOT SOLD OR INTENDED FOR USE IN ANY NUCLEAR OR NUCLEAR RELATED APPLICATIONS. Buyer (i) accepts Goods in accordance with the foregoing restriction, (ii) agrees to communicate such restriction in writing to any and all subsequent purchasers or users and (iii) agrees to defend, indemnify and hold harmless Seller from any and all claims, losses, liabilities, suits, judgements and damages, including incidental and consequential damages, arising from use of Goods in any nuclear or nuclear related applications, whether the cause of action be based in tort, contract or otherwise, including allegations that the Seller's liability is based on negligence or strict liability.

14.6 The Contract shall in all respects be construed in accordance with the laws of Belgium excluding, however, any effect on such laws of the 1980 Vienna Convention on Contracts for the International Sale of Goods and to the fullest extent permitted by law, shall be without regard to any conflict of laws or rules which might apply the laws of any other jurisdiction. All disputes arising out of the Contract shall be subject to the exclusive jurisdiction of the Belgian courts.

14.7 The headings to the Clauses and paragraphs of the Contract are for guidance only and shall not affect the interpretation thereof.

14.8 All notices and claims in connection with the Contract must be in writing.



**SUMINISTROS  
INDUSTRIALES  
DÍAZ**



Av. Puebla 515  
Col. Palma Sola, CP 93320  
Poza Rica Veracruz, México

Teléfonos

7821606595  
7821604051  
7821610766



[www.sidiaz.com](http://www.sidiaz.com)



Suministros Industriales Díaz



[contacto@sidiaz.com](mailto:contacto@sidiaz.com)



@SiDiazMex



@sidiazmex



Suministros Industriales Díaz